

# Face Recognition Access Controller

## Quick Start Guide







# Foreword

## General

This manual introduces the installation and basic operations of the Face Recognition Access Controller (hereinafter referred to as "access controller").

## Safety Instructions

The following categorized signal words with defined meaning might appear in the manual.

Signal Words	Meaning
 <b>DANGER</b>	Indicates a high potential hazard which, if not avoided, will result in death or serious injury.
 <b>WARNING</b>	Indicates a medium or low potential hazard which, if not avoided, could result in slight or moderate injury.
 <b>CAUTION</b>	Indicates a potential risk which, if not avoided, could result in property damage, data loss, lower performance, or unpredictable result.
 <b>TIPS</b>	Provides methods to help you solve a problem or save you time.
 <b>NOTE</b>	Provides additional information as the emphasis and supplement to the text.

## Revision History

Version	Revision Content	Release Time
V1.0.1	<ul style="list-style-type: none"><li>Update the distance requirement between the face and camera.</li><li>Add a warning statement.</li></ul>	August 2020
V1.0.0	First release.	May 2020

## About the Manual

- The manual is for reference only. If there is inconsistency between the manual and the actual product, the actual product shall prevail.
- We are not liable for any loss caused by the operations that do not comply with the manual.
- The manual would be updated according to the latest laws and regulations of related regions. For detailed information, see the paper manual, CD-ROM, QR code or our official website. If there is inconsistency between paper manual and the electronic version, the electronic version shall prevail.
- All the designs and software are subject to change without prior written notice. The product updates might cause some differences between the actual product and the manual. Please

contact the customer service for the latest program and supplementary documentation.

- There still might be deviation in technical data, functions and operations description, or errors in print. If there is any doubt or dispute, please refer to our final explanation.
- Upgrade the reader software or try other mainstream reader software if the manual (in PDF format) cannot be opened.
- All trademarks, registered trademarks and the company names in the manual are the properties of their respective owners.
- Please visit our website, contact the supplier or customer service if there is any problem occurred when using the device.
- If there is any uncertainty or controversy, please refer to our final explanation.

# Important Safeguards and Warnings

This chapter describes the contents covering proper handling of the access controller, hazard prevention, and prevention of property damage. Read these contents carefully before using the access controller, comply with them when using, and keep the manual well for future reference.

## Operation Requirements

- Do not place or install the access controller in a place exposed to sunlight or near the heat source.
- Keep the access controller away from dampness, dust or soot.
- Keep the access controller installed horizontally on the stable place to prevent it from falling.
- Do not drop or splash liquid onto the access controller, and make sure that there is no object filled with liquid on the access controller to prevent liquid from flowing into the access controller.
- Install the access controller in a well-ventilated place, and do not block the ventilation of the access controller.
- Operate the access controller within the rated range of power input and output.
- Do not disassemble the access controller randomly.
- When used in outdoors with high temperature, do not directly touch the surface of the access controller, such as the screen, metal back shell, and fingerprint sensor.

## Electrical Safety

- Improper battery use might result in fire, explosion, or inflammation.
- When replacing battery, make sure the same model is used.
- Use the recommended power cables in the region and conform to the rated power specification.
- Use the power adapter provided with the access controller; otherwise, it might result in people injury and device damage.
- The power source shall conform to the requirement of the Safety Extra Low Voltage (SELV) standard, and supply power with rated voltage which conforms to Limited power Source requirement according to IEC60950-1. Please note that the power supply requirement is subject to the device label.
- Connect the device (I-type structure) to the power socket with protective earthing.
- The appliance coupler is a disconnection device. When using the coupler, keep the angle for easy operation.

# Table of Contents

<b>Foreword</b> .....	<b>I</b>
<b>Important Safeguards and Warnings</b> .....	<b>III</b>
<b>1 Dimensions and Components</b> .....	<b>1</b>
<b>2 Connection and Installation</b> .....	<b>3</b>
2.1 Cable Connection .....	3
2.2 Installation Notes.....	6
2.3 Installation .....	7
2.3.1 Installation of Model G.....	7
2.3.2 Installation of Model J.....	9
<b>3 System Operations</b> .....	<b>12</b>
3.1 Initialization .....	12
3.2 Adding New Users .....	12
<b>4 Web Operations</b> .....	<b>15</b>
<b>Appendix 1 Notes of Face Recording/Comparison</b> .....	<b>16</b>
<b>Appendix 2 Fingerprint Record Instruction</b> .....	<b>19</b>
<b>Appendix 3 Cybersecurity Recommendations</b> .....	<b>21</b>

# 1 Dimensions and Components

Figure 1-1 Dimensions and components of model G (mm [inch])

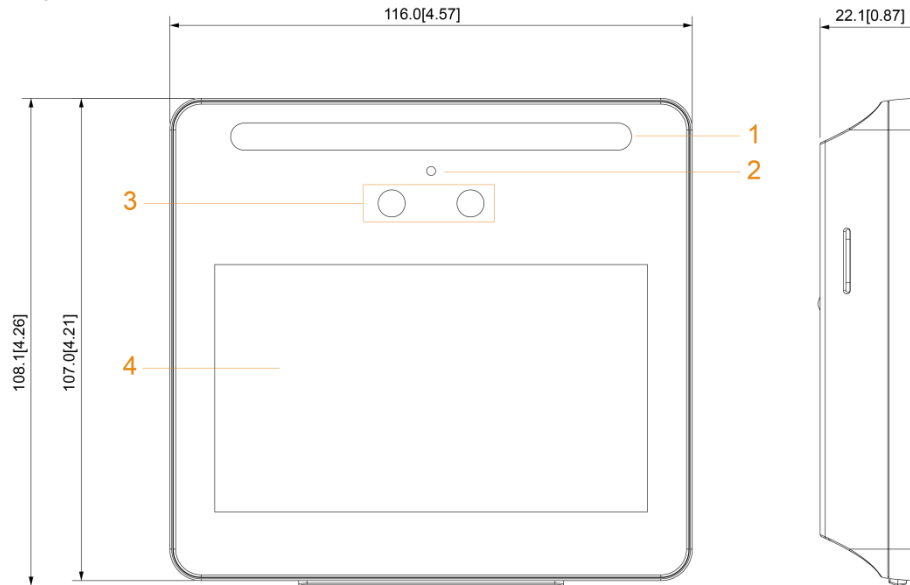

Table 1-1 Component description

No.	Name	No.	Name
1	White LED illuminator	3	Dual cameras
2	Mic	4	Display

Figure 1-2 Dimensions and components of model J with fingerprint sensor (mm [inch])

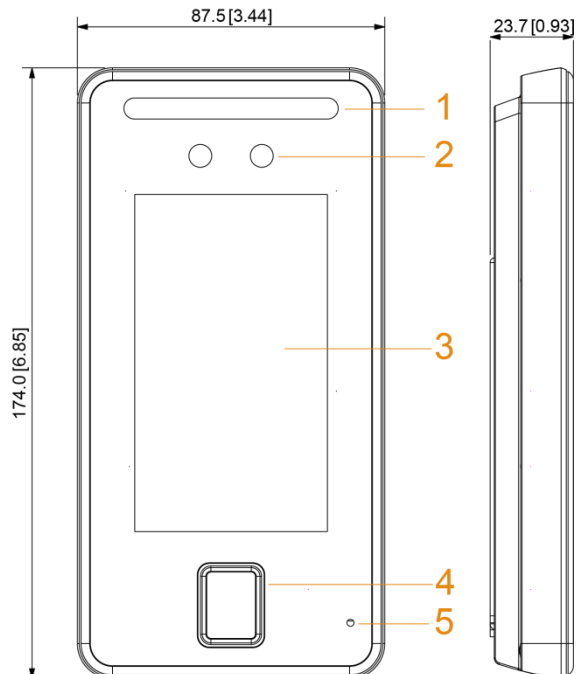

Table 1-2 Component description

No.	Name	No.	Name
1	White LED illuminator	3	Display
2	Dual cameras	4	Fingerprint sensor

5	Mic	—	—
---	-----	---	---

Figure 1-3 Dimensions and components of model J without fingerprint sensor (mm [inch])

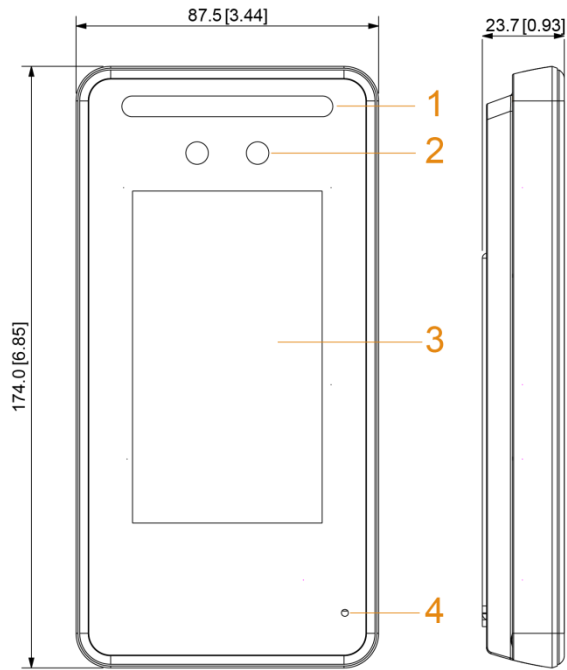

Table 1-3 Component description

No.	Name	No.	Name
1	White LED illuminator	3	Display
2	Dual cameras	4	Mic

# 2 Connection and Installation

## 2.1 Cable Connection



- Check whether the access control security module is enabled in **Function > Security Module**. If enabled, you need to purchase access control security module separately. The security module needs separate power supply.
- Once the security module is enabled, the exit button, turnstile control, and firefighting linkage will be invalid.

### Cable Connection of Model G

Figure 2-1 Cable connection of model G

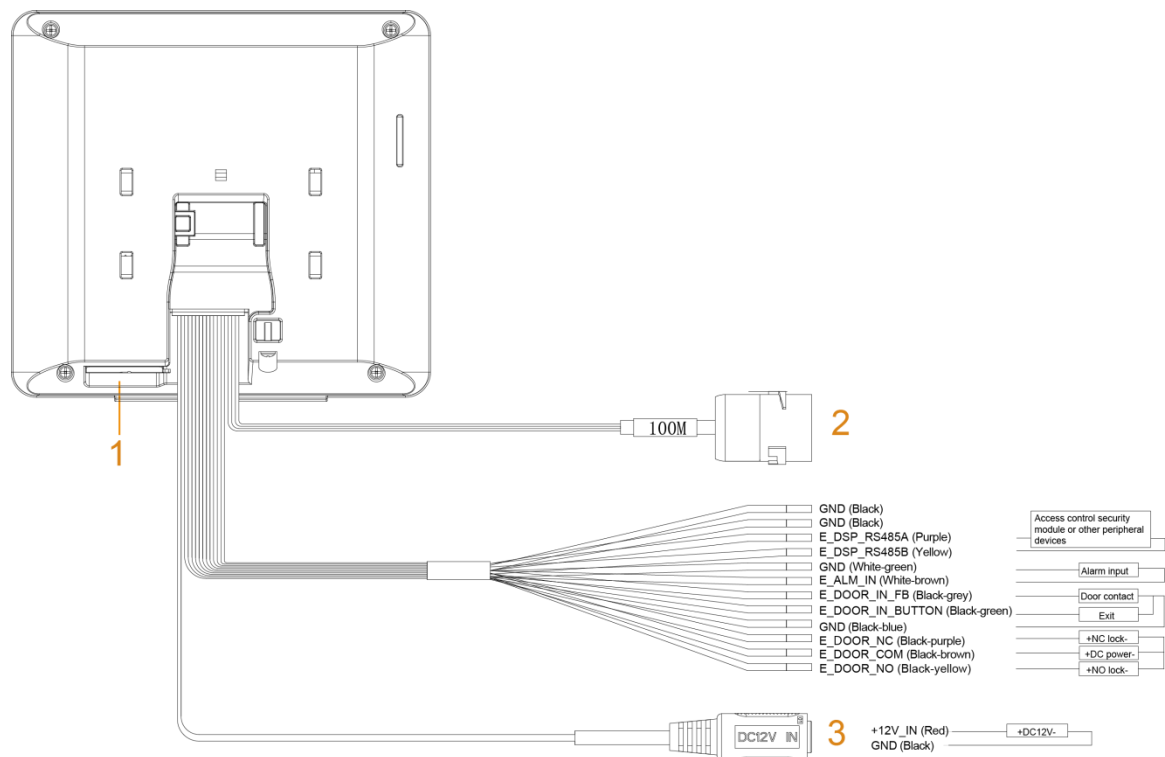



Figure 2-2 Ports of model G

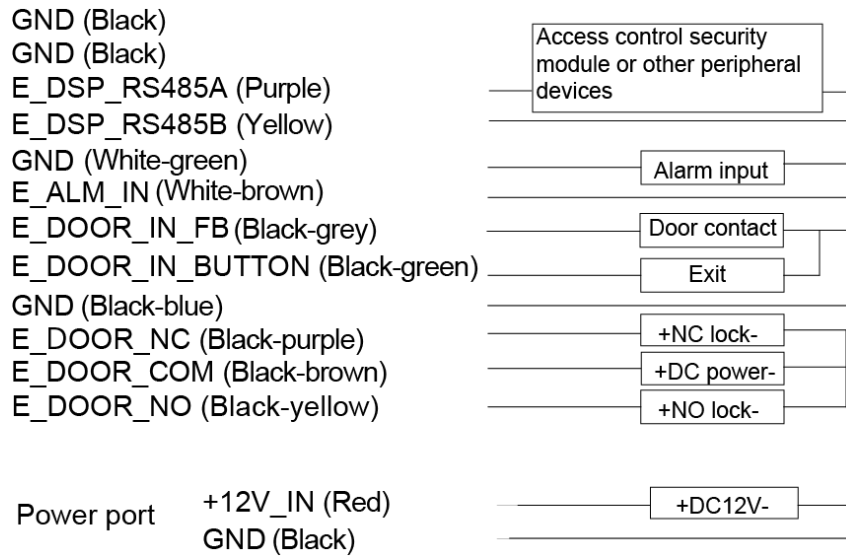

Table 2-1 Component description

No.	Name
1	USB port
2	100M network port
3	Power port

# Cable Connection of Model J

Figure 2-3 Cable connection of model J

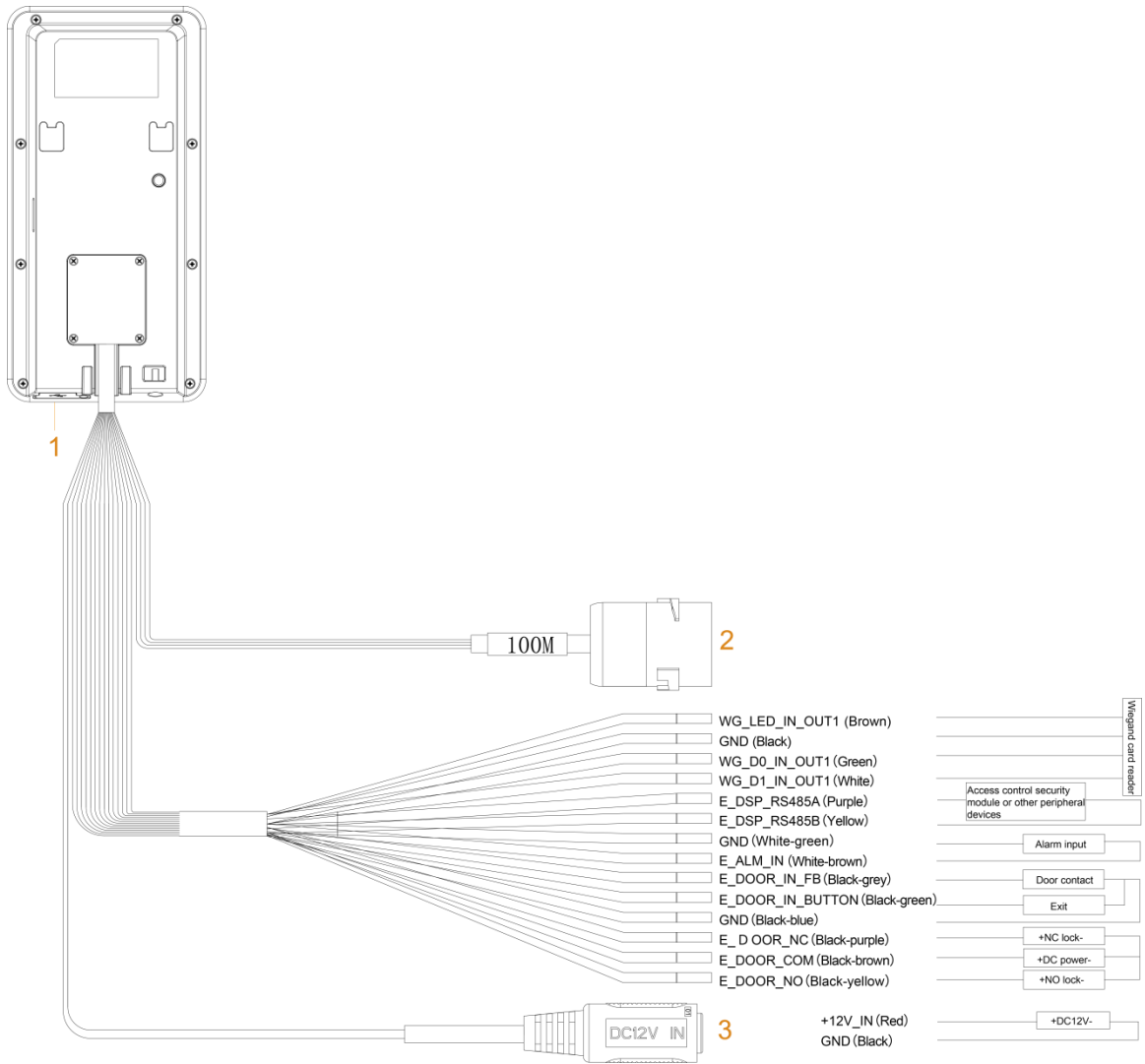

Figure 2-4 Ports of model J

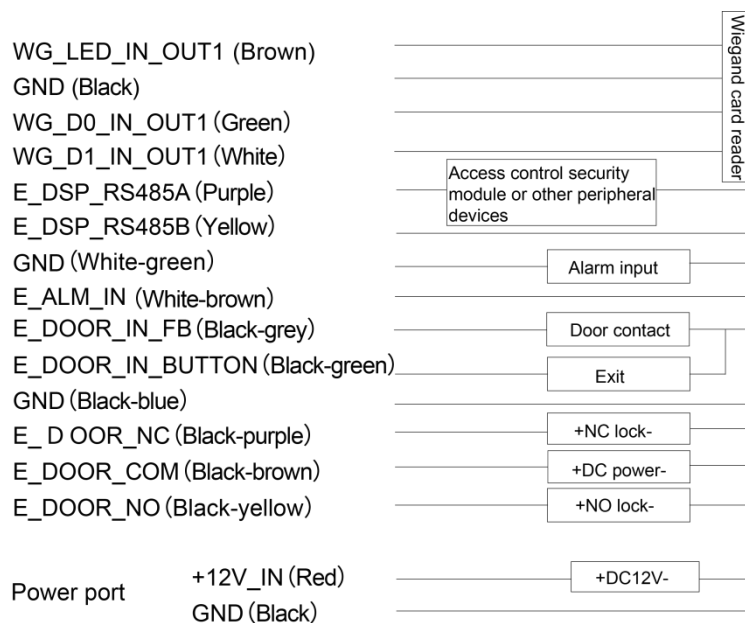

Table 2-2 Component description

No.	Name
1	USB port
2	100M network port
3	Power port

## 2.2 Installation Notes



- If there is light source 0.5 meters away from the access controller, the minimum illumination should be no less than 100 Lux.
- It is recommended that the access controller is installed indoors, at least 3 meters away from windows and doors and 2 meters away from lights.
- Avoid backlight and direct sunlight.

### Ambient Illumination Requirement

Figure 2-5 Ambient illumination requirement



Candle: 10Lux



Light bulb: 100Lux–850Lux



Sunlight:  $\geq 1200$ Lux

### Places Recommended

Figure 2-6 Places recommended

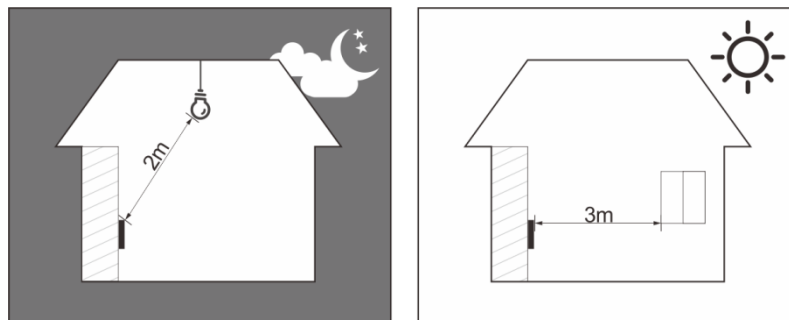

## Places Not Recommended

Figure 2-7 Places not recommended

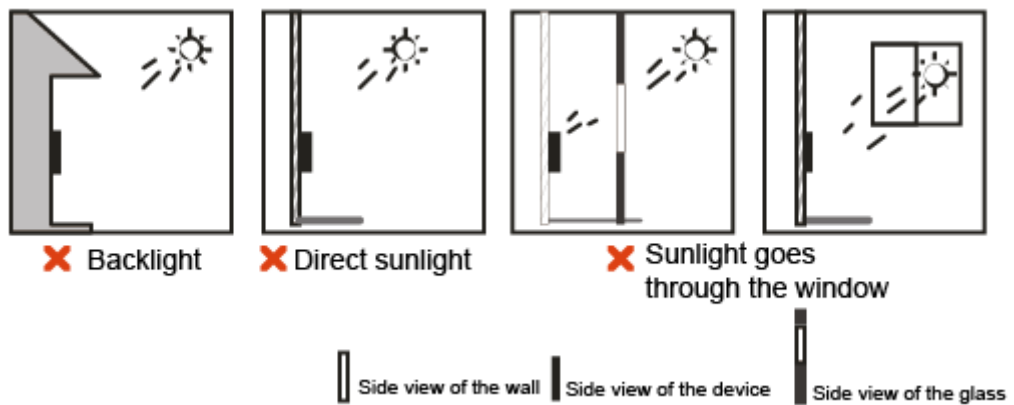

## 2.3 Installation

### 2.3.1 Installation of Model G

#### Desktop Installation

Insert the buckle of the desktop bracket into the rear slot of the access controller, and then slide it down to the end.

Figure 2-8 Desktop installation (1)

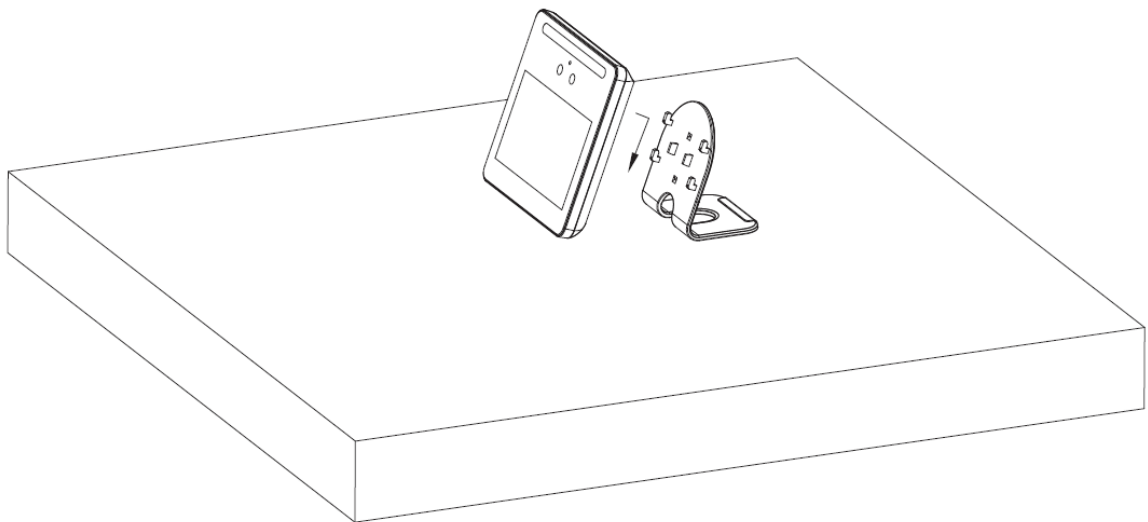
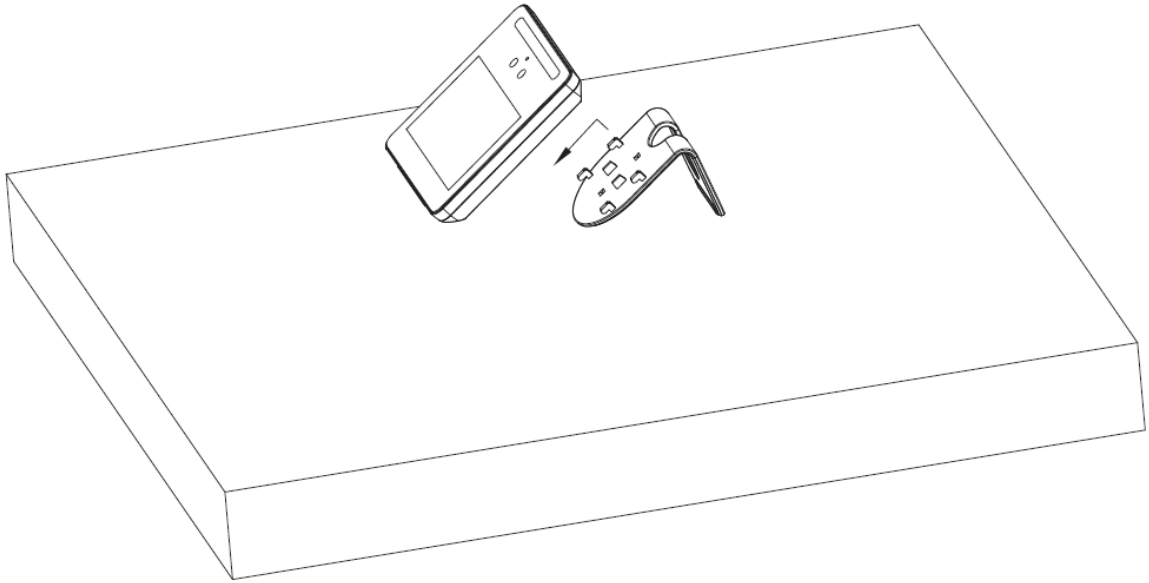

Figure 2-9 Desktop installation (2)



## Wall Installation

The recommended distance between the lens and ground is 1.4–1.6 meters.

Figure 2-1 Installation height

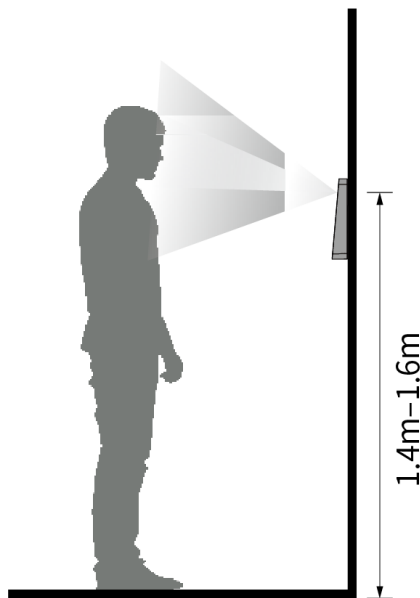
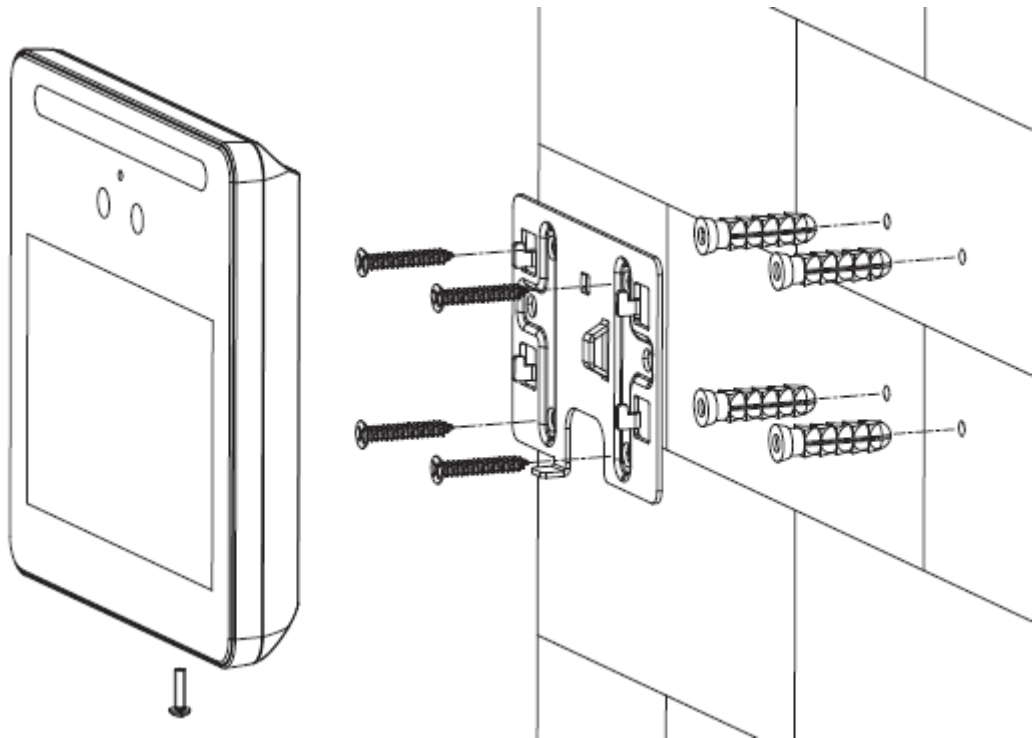

Figure 2-2 Wall installation



- Step 1 Drill four holes in the wall according to holes in the bracket.
- Step 2 Fix the bracket on the wall by installing the expansion screws into the four bracket installation holes.
- Step 3 Connect cables for access controller. See "2.1 Cable Connection".
- Step 4 Hang the access controller on the bracket hook.
- Step 5 Tighten the screws at the bottom of the access controller.

### 2.3.2 Installation of Model J

The recommended distance between the lens and ground is 1.4 meters.

Figure 2-3 Installation height

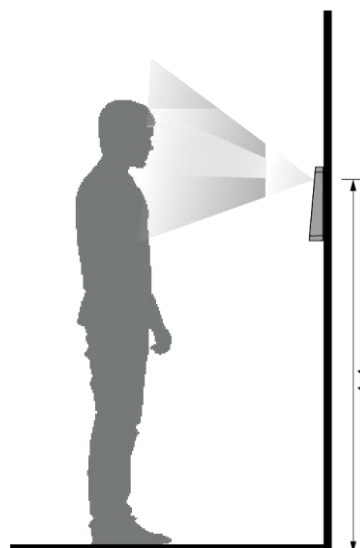

Figure 2-4 Wall installation

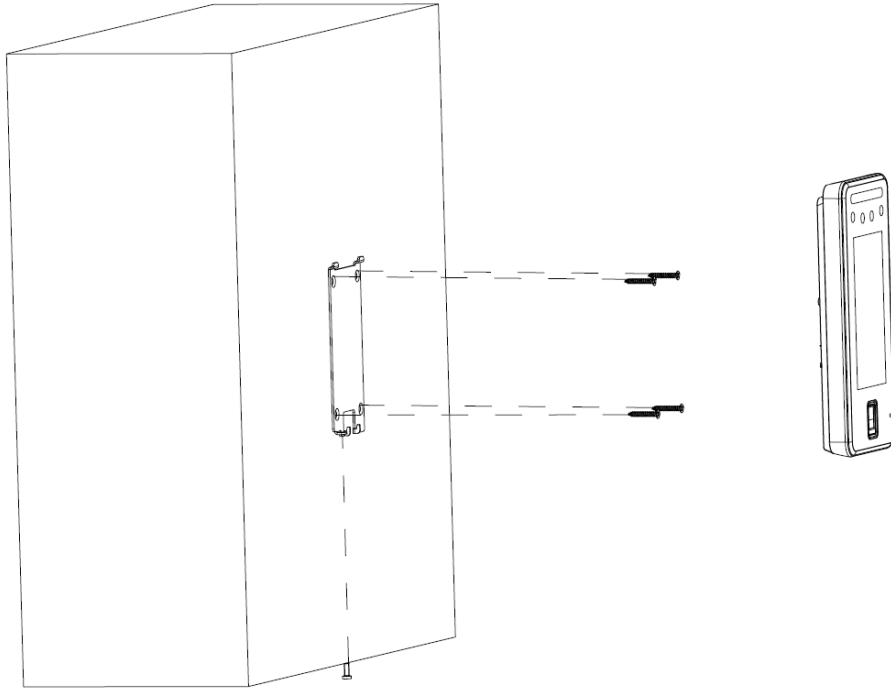
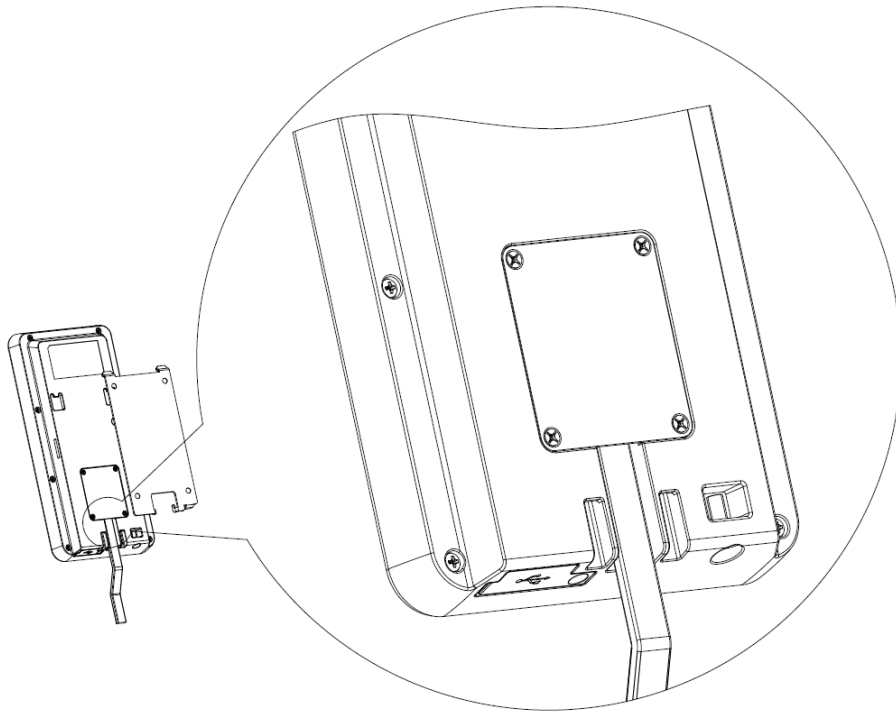

Figure 2-5 Applying silicon sealant to the access controller



## Installation Procedure

- Step 1 Drill four holes in the wall according to holes in the bracket.
- Step 2 Fix the bracket on the wall by installing the expansion screws into the four bracket installation holes.
- Step 3 Connect cables for access controller. See "2.1 Cable Connection".
- Step 4 Apply silicon sealant to gaps of the cable entry for waterproof. See Figure 2-5.
- Step 5 Hang the access controller on the bracket hook.
- Step 6 Tighten the screws at the bottom of the access controller.

Step 7 Apply silicon sealant to gaps between the wall and the access controller.



# 3 System Operations

## 3.1 Initialization

Administrator password and an email should be set the first time the access controller is turned on; otherwise the access controller cannot be used.

Figure 3-1 Initialization

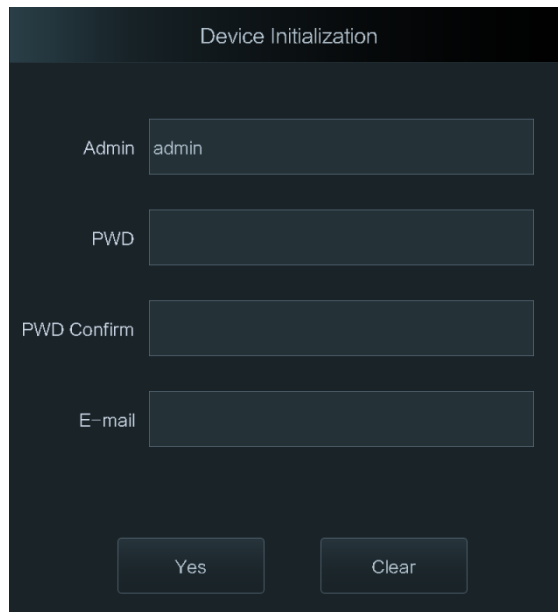

- The administrator password can be reset through the email address that you entered if the administrator forgets the administrator password.
- The password must consist of 8 to 32 non-blank characters and contain at least two types of characters among upper case, lower case, number, and special character (excluding ' ; : & ).
- For access controllers without touch screen, initialization can be completed through the web interface. See the user manual for details.

## 3.2 Adding New Users

You can add new users by entering user IDs, names, importing fingerprints, face images, passwords, and selecting user levels.



The following figures are for reference only, and the actual interface shall prevail.

Step 1 On the standby interface, long press 3 s to go to the **Administrator Login** interface.

Step 2 Tap **Admin** to log in to the **Main Menu** interface with an admin account.

Step 3 Select **User > New User**.



Figure 3-2 New user

Parameter	Value
User ID	1
User Level	General
Name	
FP	0
Face	0
Card	0
PWD	
User Level	User
Period	255-Default
Holiday Plan	255-Default
Valid Date	2037-12-31

**Step 4** Configure parameters on the interface.

Table 3-1 New user parameter description

Parameter	Description
User ID	Enter user IDs. The IDs consist of 32 characters (including numbers and letters), and each ID is unique.
Name	Enter names with at most 32 characters (including numbers, symbols, and letters).
FP	<p>At most three fingerprints of one user can be recorded, and one fingerprints need to be verified three times.</p> <p>You can enable the Duress FP function under each fingerprint, and only one of the three fingerprints can be the duress fingerprint. Alarms will be triggered if a duress fingerprint is used to unlock the door.</p> <p></p> <ul style="list-style-type: none"> <li>It is not recommended that you select the first fingerprint as the duress fingerprint.</li> <li>Fingerprint unlock is only supported by access controllers with fingerprint sensors.</li> </ul>
Face	Make sure that your face is centered on the picture capturing frame, and then a picture of your face will be automatically captured. For details about face image recording, see "Appendix 1 Notes of Face Recording/Comparison."

Card	<p>You can register at most five cards for each user. On the card registration interface, enter your card number or swipe your card, and then the card information will be read by the access controller.</p> <p>You can enable the Duress Card function on the card registration interface. Alarms will be triggered if a duress card is used to unlock the door.</p>  <p>If the access controller is without card reading module, you need to connect the device to peripheral card readers.</p>
PWD	<p>The door unlocking password. The maximum length of the password is 8 digits.</p>  <p>If the access controller is without touch screen, you need to connect the access controller to a peripheral card reader. There are buttons on the card reader.</p>
Level	<p>You can select a user level for new users. There are two options.</p> <ul style="list-style-type: none"> <li>• User: Users only have door unlock permission.</li> <li>• Admin: Administrators can unlock the door and also have parameter configuration permission.</li> </ul>  <p>In case that you forget the administrator password, you had better create more than one administrator.</p>
Period	The period in which the user can unlock the door. For detailed period settings, see the user manual.
Holiday Plan	You can set a holiday plan in which the user can unlock the door. For detailed holiday plan settings, see the user manual.
Valid Date	You can set a period during which the unlocking information of the user is valid.
User Level	<p>There are eight levels:</p> <ul style="list-style-type: none"> <li>• General: General users can unlock the door normally.</li> <li>• Blacklist: When users in the blacklist unlock the door, service personnel will get a prompt.</li> <li>• Guest: Guests are allowed to unlock the door certain times or in certain periods. Once they exceed the maximum times or periods, they cannot unlock the door.</li> <li>• Patrol: Patrolling users can get their attendance tracked, but they have no unlock permission.</li> <li>• VIP: When VIP unlocks the door, service personnel will get a prompt.</li> <li>• Special: When special people unlock the door, there will be a delay of 5 seconds before the door is closed.</li> <li>• Custom User 1: Reserved for customization. Users can unlock the door normally.</li> <li>• Custom User 2: Reserved for customization. Users can unlock the door normally.</li> </ul>
Use Time	When the user level is Guest, you can set the maximum number of times that the guest can unlock the door.

Step 5 Tap  to save the configuration.

# 4 Web Operations

The access controller can be configured and operated on the web interface. Through the web interface you can set parameters including network parameters, video parameters, and access controller parameters; and you can also maintain and update the system. For details, see the user manual. Here only describe the login operation.



You need to set a password and an email address before logging in to the web interface for the first time. Password you set is used to log in to the web, and the email is used to reset passwords.

**Step 1** Open IE web browser, enter the IP address of the access controller in the address bar, and then press Enter key.



- Make sure that the IP address of computer used to log in to the web is in the same LAN with the access controller.
- The default IP address of the access controller is 192.168.1.108.

Figure 4-1 Login

**WEB SERVICE**

Username:

Password:

[Forget Password?](#)

**Login**

**Step 2** Enter the username and password.



- The default username of administrator is admin, and the password is the login password after initializing the access controller. Modify the administrator password regularly and keep it properly for security.
- If you forget the administrator login password, you can click **Forget Password?** to reset it. See the user manual.

**Step 3** Click **Login**.

The homepage of the web interface is displayed.

# Appendix 1 Notes of Face Recording/Comparison

## Before Registration

- Glasses, hats, and beards might influence face recognition performance.
- Do not cover your eyebrows when wearing hats.
- Do not change your beard style greatly if you will use the device; otherwise face recognition might fail.
- Keep your face clean.
- Keep the device at least two meters away from light source and at least three meters away from windows or doors; otherwise backlight and direct sunlight might influence face recognition performance of the device.

## During Registration

You can register faces through the access controller or through the platform. For registration through the platform, see the platform user manual.

Make your head center on the photo capture frame. A picture of your face will be captured automatically.

Appendix Figure 1-1 Registration

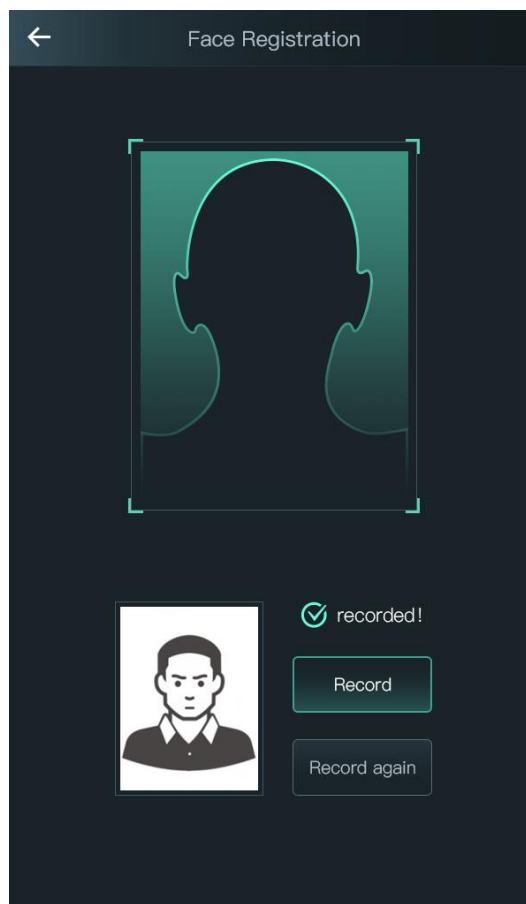



- Do not shake your head or body, otherwise the registration might fail.
- Avoid two faces appear in the capture frame at the same time.

## Face Position

If your face is not at the appropriate position, face recognition effect might be influenced.

Appendix Figure 1-2 Appropriate face position

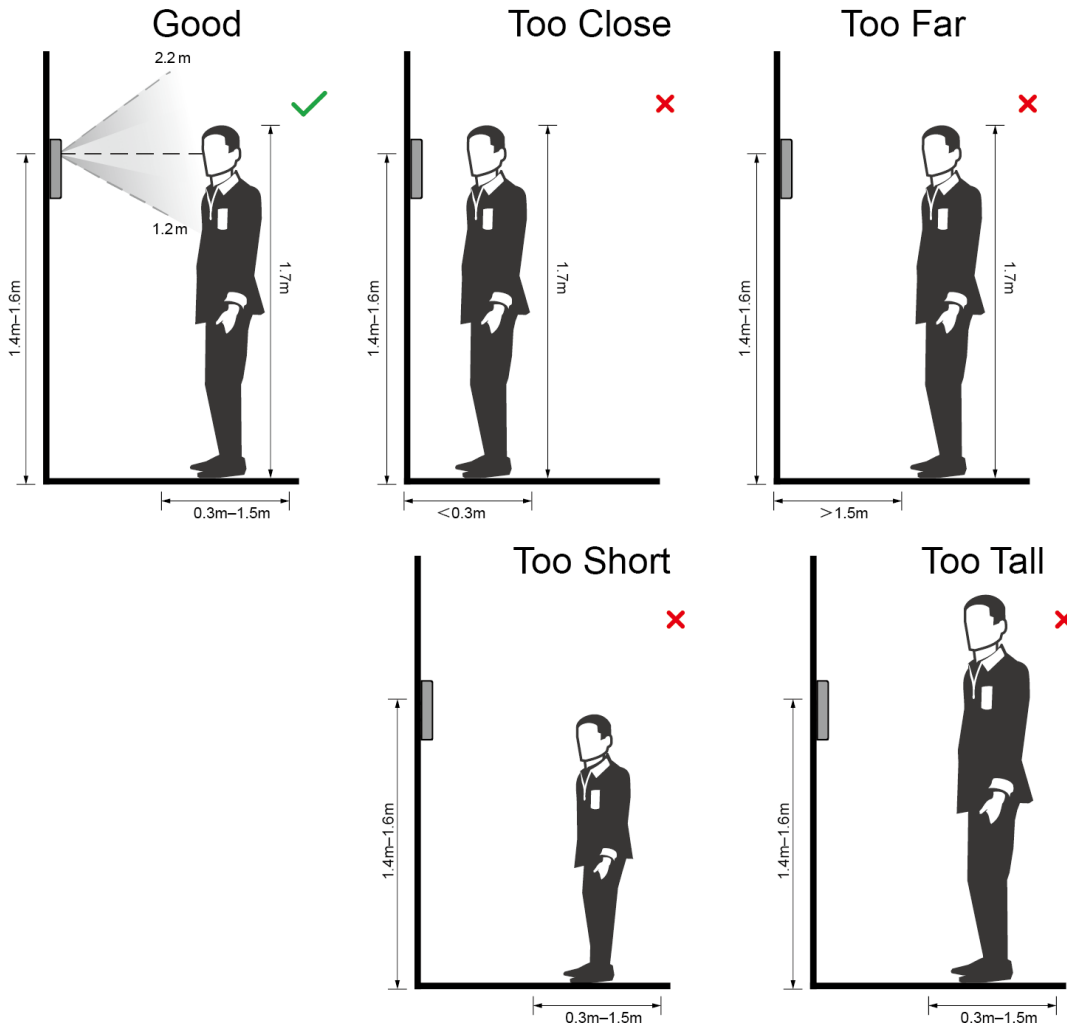

## Requirements of Faces

- Make sure that the face is clean and forehead is not covered by hair.
- Do not wear glasses, hats, heavy beards, or other face ornaments that influence face image recording.
- With eyes open, without facial expressions, and make your face toward the center of camera.
- When recording your face or during face recognition, do not keep your face too close to or too far from the camera.

Appendix Figure 1-3 Head position

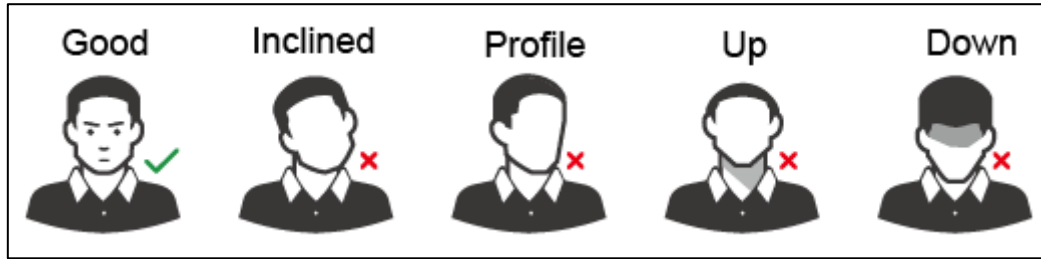

Appendix Figure 1-4 Face distance

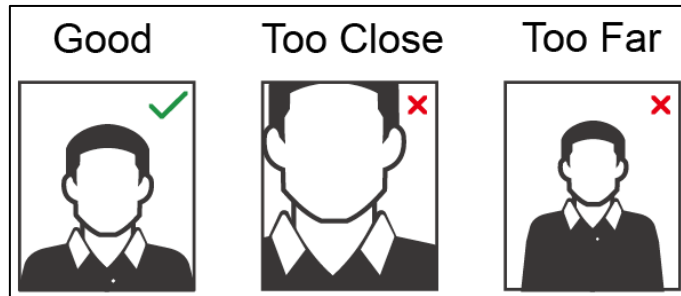

- When importing face images through the management platform, make sure that image resolution is within the range 150 × 300–600 × 1200; image pixels are more than 500 × 500; image size is less than 75 KB, and image name and person ID are the same.
- Make sure that face does not take 2/3 of the whole image area, and the aspect ratio does not exceed 1:2.

# Appendix 2 Fingerprint Record Instruction

## Notice

- Make sure that your fingers are clean and dry before recording your fingerprints.
- Press your finger to the fingerprint recording area, and make your fingerprint is centered on the recording area.
- Do not put the fingerprint sensor at places with intense light, high temperature, and high humidity.
- If your fingerprints are worn or are unclear, try other unlock methods.

## Fingers Recommended

Forefingers, middle fingers, and ring fingers are recommended. Thumbs and little fingers cannot be put at the recording center easily.

Appendix figure 1-1 Recommended fingers

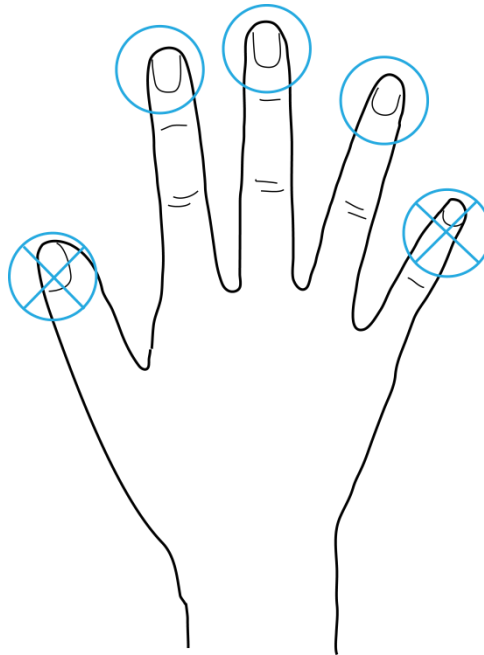

## Finger Pressing Method

- Correct method



Appendix figure 1-2 Correct finger pressing

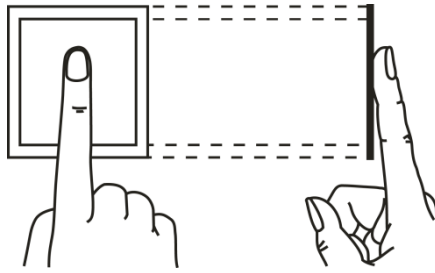

- Incorrect method

Appendix figure 1-3 Wrong finger pressing

Fingertip perpendicular to the record area

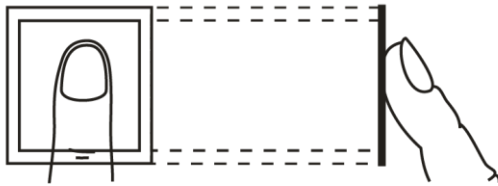

Fingertip not at the center of the record area

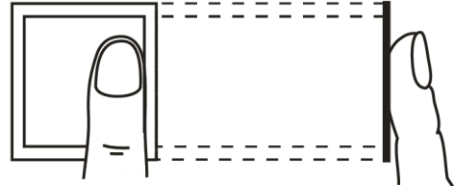

Fingertip not at the center of the record area

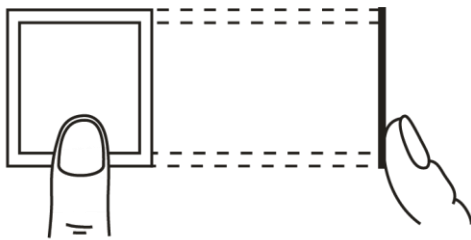

Fingertip inclination

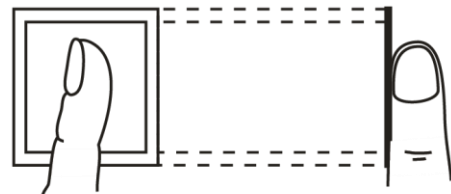

# Appendix 3 Cybersecurity Recommendations

Cybersecurity is more than just a buzzword: it's something that pertains to every device that is connected to the internet. IP video surveillance is not immune to cyber risks, but taking basic steps toward protecting and strengthening networks and networked appliances will make them less susceptible to attacks. Below are some tips and recommendations on how to create a more secured security system.

## **Mandatory actions to be taken for basic equipment network security:**

### **1. Use Strong Passwords**

Please refer to the following suggestions to set passwords:

- The length should not be less than 8 characters;
- Include at least two types of characters; character types include upper and lower case letters, numbers and symbols;
- Do not contain the account name or the account name in reverse order;
- Do not use continuous characters, such as 123, abc, etc.;
- Do not use overlapped characters, such as 111, aaa, etc.;

### **2. Update Firmware and Client Software in Time**

- According to the standard procedure in Tech-industry, we recommend to keep your equipment (such as NVR, DVR, IP camera, etc.) firmware up-to-date to ensure the system is equipped with the latest security patches and fixes. When the equipment is connected to the public network, it is recommended to enable the "auto-check for updates" function to obtain timely information of firmware updates released by the manufacturer.
- We suggest that you download and use the latest version of client software.

## **"Nice to have" recommendations to improve your equipment network security:**

### **1. Physical Protection**

We suggest that you perform physical protection to equipment, especially storage devices. For example, place the equipment in a special computer room and cabinet, and implement well-done access control permission and key management to prevent unauthorized personnel from carrying out physical contacts such as damaging hardware, unauthorized connection of removable equipment (such as USB flash disk, serial port), etc.

### **2. Change Passwords Regularly**

We suggest that you change passwords regularly to reduce the risk of being guessed or cracked.

### **3. Set and Update Passwords Reset Information Timely**

The equipment supports password reset function. Please set up related information for password reset in time, including the end user's mailbox and password protection questions. If the information changes, please modify it in time. When setting password protection questions, it is suggested not to use those that can be easily guessed.

### **4. Enable Account Lock**

The account lock feature is enabled by default, and we recommend you to keep it on to guarantee the account security. If an attacker attempts to log in with the wrong password several times, the corresponding account and the source IP address will be locked.

### **5. Change Default HTTP and Other Service Ports**

We suggest you to change default HTTP and other service ports into any set of numbers between 1024~65535, reducing the risk of outsiders being able to guess which ports you are using.

#### **6. Enable HTTPS**

We suggest you to enable HTTPS, so that you visit web service through a secure communication channel.

#### **7. Enable Whitelist**

We suggest you to enable whitelist function to prevent everyone, except those with specified IP addresses, from accessing the system. Therefore, please be sure to add your computer's IP address and the accompanying equipment's IP address to the whitelist.

#### **8. MAC Address Binding**

We recommend you to bind the IP and MAC address of the gateway to the equipment, thus reducing the risk of ARP spoofing.

#### **9. Assign Accounts and Privileges Reasonably**

According to business and management requirements, reasonably add users and assign a minimum set of permissions to them.

#### **10. Disable Unnecessary Services and Choose Secure Modes**

If not needed, it is recommended to turn off some services such as SNMP, SMTP, UPnP, etc., to reduce risks.

If necessary, it is highly recommended that you use safe modes, including but not limited to the following services:

- SNMP: Choose SNMP v3, and set up strong encryption passwords and authentication passwords.
- SMTP: Choose TLS to access mailbox server.
- FTP: Choose SFTP, and set up strong passwords.
- AP hotspot: Choose WPA2-PSK encryption mode, and set up strong passwords.

#### **11. Audio and Video Encrypted Transmission**

If your audio and video data contents are very important or sensitive, we recommend that you use encrypted transmission function, to reduce the risk of audio and video data being stolen during transmission.

Reminder: encrypted transmission will cause some loss in transmission efficiency.

#### **12. Secure Auditing**

- Check online users: we suggest that you check online users regularly to see if the device is logged in without authorization.
- Check equipment log: By viewing the logs, you can know the IP addresses that were used to log in to your devices and their key operations.

#### **13. Network Log**

Due to the limited storage capacity of the equipment, the stored log is limited. If you need to save the log for a long time, it is recommended that you enable the network log function to ensure that the critical logs are synchronized to the network log server for tracing.

#### **14. Construct a Safe Network Environment**

In order to better ensure the safety of equipment and reduce potential cyber risks, we recommend:

- Disable the port mapping function of the router to avoid direct access to the intranet devices from external network.
- The network should be partitioned and isolated according to the actual network needs. If there are no communication requirements between two sub networks, it is

suggested to use VLAN, network GAP and other technologies to partition the network, so as to achieve the network isolation effect.

- Establish the 802.1x access authentication system to reduce the risk of unauthorized access to private networks.
- It is recommended that you enable your device's firewall or blacklist and whitelist feature to reduce the risk that your device might be attacked.

# **Face Recognition Access Controller**

## **User's Manual**



# Foreword

## General





This manual introduces the installation and detailed operations of the Face Recognition Access Controller (hereinafter referred to as "access controller").



This manual applies to model G and model J access controllers. Figures of model G access controllers are demonstrated in the manual for example.

## Safety Instructions

The following categorized signal words with defined meaning might appear in the manual.

Signal Words	Meaning
 <b>DANGER</b>	Indicates a high potential hazard which, if not avoided, will result in death or serious injury.
 <b>WARNING</b>	Indicates a medium or low potential hazard which, if not avoided, could result in slight or moderate injury.
 <b>CAUTION</b>	Indicates a potential risk which, if not avoided, could result in property damage, data loss, lower performance, or unpredictable result.
 <b>TIPS</b>	Provides methods to help you solve a problem or save you time.
 <b>NOTE</b>	Provides additional information as the emphasis and supplement to the text.

## Revision History

Version	Revision Content	Release Date
V1.0.1	<ul style="list-style-type: none"><li>Update the figure of face detect interface.</li><li>Update the distance requirement between the face and camera.</li><li>Add a warning statement.</li></ul>	August 2020
V1.0.0	First Release.	June 2020

## About the Manual

- The manual is for reference only. If there is inconsistency between the manual and the actual product, the actual product shall prevail.
- We are not liable for any loss caused by the operations that do not comply with the manual.
- The manual would be updated according to the latest laws and regulations of related regions. For detailed information, see the paper manual, CD-ROM, QR code or our official

website. If there is inconsistency between paper manual and the electronic version, the electronic version shall prevail.

- All the designs and software are subject to change without prior written notice. The product updates might cause some differences between the actual product and the manual. Please contact the customer service for the latest program and supplementary documentation.
- There still might be deviation in technical data, functions and operations description, or errors in print. If there is any doubt or dispute, please refer to our final explanation.
- Upgrade the reader software or try other mainstream reader software if the manual (in PDF format) cannot be opened.
- All trademarks, registered trademarks and the company names in the manual are the properties of their respective owners.
- Please visit our website, contact the supplier or customer service if there is any problem occurred when using the device.
- If there is any uncertainty or controversy, please refer to our final explanation.

# Important Safeguards and Warnings

This chapter describes the contents covering proper handling of the access controller, hazard prevention, and prevention of property damage. Read these contents carefully before using the access controller, comply with them when using, and keep them well for future reference.

## Operation Requirement

- Do not place or install the access controller in a place exposed to sunlight or near the heat source.
- Keep the access controller away from dampness, dust or soot.
- Keep the access controller installed horizontally on the stable place to prevent it from falling.
- Do not drop or splash liquid onto the access controller, and make sure there is no object filled with liquid on the access controller to prevent liquid from flowing into the access controller.
- Install the access controller in a well-ventilated place, and do not block the ventilation of the access controller.
- Operate the access controller within the rated range of power input and output.
- Do not disassemble the access controller randomly.
- Transport, use and store the access controller under the allowed humidity and temperature conditions.
- When used in outdoors with high temperature, do not directly touch the surface of the access controller, such as the screen, metal back shell, and fingerprint sensor.

## Electrical Safety

- Improper battery use might result in fire, explosion, or inflammation.
- When replacing battery, make sure the same model is used.
- Use the recommended power cables in the region and conform to the rated power specification.
- Use the power adapter provided with the access controller; otherwise, it might result in people injury and device damage.
- The power source shall conform to the requirement of the Safety Extra Low Voltage (SELV) standard, and supply power with rated voltage which conforms to Limited power Source requirement according to IEC60950-1. Please note that the power supply requirement is subject to the device label.
- Connect the device (I-type structure) to the power socket with protective earthing.
- The appliance coupler is a disconnection device. When using the coupler, keep the angle for easy operation.



# Table of Contents

<b>Foreword</b> .....	<b>I</b>
<b>Important Safeguards and Warnings</b> .....	<b>III</b>
<b>1 Overview</b> .....	<b>1</b>
1.1 Introduction .....	1
1.2 Features .....	1
1.3 Application .....	1
1.4 Dimension and Component .....	2
<b>2 Connection and Installation</b> .....	<b>5</b>
2.1 Cable Connections .....	5
2.2 Installation Notes .....	8
2.3 Installation .....	9
2.3.1 Installation of Model G .....	9
2.3.2 Installation of Model J .....	11
<b>3 System Operations</b> .....	<b>14</b>
3.1 Basic Configuration Procedure .....	14
3.2 Common Icons .....	14
3.3 Initialization .....	15
3.4 Standby Interface .....	15
3.5 Main Menu .....	17
3.6 Unlocking Methods .....	18
3.6.1 Cards .....	18
3.6.2 Face .....	18
3.6.3 Fingerprints .....	18
3.6.4 User Password .....	19
3.6.5 Administrator Password .....	19
3.7 User Management .....	19
3.7.1 Adding New Users .....	19
3.7.2 Viewing User information .....	21
3.8 Access Management .....	22
3.8.1 Period Management .....	22
3.8.2 Unlock .....	23
3.8.3 Alarm Configuration .....	27
3.8.4 Door Status .....	28
3.8.5 Lock Holding Time .....	28
3.9 Attendance .....	28
3.10 Network Communication .....	29
3.10.1 IP Configuration .....	29
3.10.2 Active Register .....	30
3.10.3 Wi-Fi .....	31
3.10.4 Serial Port Settings .....	31
3.10.5 Wiegand Configuration .....	32
3.11 System .....	33
3.11.1 Time .....	33
3.11.2 Face Parameter .....	33

3.11.3 Image Mode .....	34
3.11.4 Volume Adjustment .....	35
3.11.5 Language Setting .....	35
3.11.6 Infrared Light Brightness Adjustment.....	35
3.11.7 Screen Setting .....	35
3.11.8 Restore to Factory Settings .....	35
3.11.9 Reboot.....	36
3.12 USB .....	36
3.12.1 USB Export .....	36
3.12.2 USB Import .....	37
3.12.3 USB Update.....	38
3.13 Features .....	38
3.13.1 Privacy Setting.....	40
3.13.2 Result Feedback.....	41
3.14 Record.....	43
3.15 System Info .....	44
<b>4 Web Operations.....</b>	<b>45</b>
4.1 Initialization .....	45
4.2 Login.....	47
4.3 Resetting the Password .....	47
4.4 Alarm Linkage .....	49
4.4.1 Setting Alarm Linkage.....	49
4.4.2 Alarm Log.....	50
4.5 Data Capacity.....	51
4.6 Video Setting.....	51
4.6.1 Data Rate.....	52
4.6.2 Image .....	53
4.6.3 Exposure.....	54
4.6.4 Motion Detection.....	55
4.6.5 Volume Setting.....	57
4.6.6 Image Mode.....	57
4.7 Face Detect.....	58
4.8 Network Setting.....	59
4.8.1 TCP/IP .....	59
4.8.2 Port .....	60
4.8.3 Register.....	61
4.8.4 P2P .....	61
4.9 Safety Management.....	62
4.9.1 IP Authority.....	62
4.9.2 Systems .....	63
4.10 User Management .....	64
4.10.1 Adding Users .....	64
4.10.2 Modifying User Information.....	64
4.10.3 ONVIF User .....	64
4.11 Maintenance.....	65
4.12 Configuration Management .....	65
4.12.1 Exporting Configuration File .....	65

4.12.2 Importing Configuration File .....	66
4.13 Upgrade .....	66
4.14 Version Information .....	67
4.15 Online User .....	67
4.16 System Log .....	68
4.16.1 Querying Logs .....	68
4.16.2 Backup Logs .....	69
4.16.3 Admin Log .....	69
4.17 Exit .....	69
<b>5 SmartPSS AC Configuration .....</b>	<b>70</b>
5.1 Login.....	70
5.2 Adding Devices .....	70
5.2.1 Auto Search .....	70
5.2.2 Manual Add.....	71
5.3 User Management .....	72
5.3.1 Card Type Setting .....	72
5.3.2 Adding User .....	73
5.3.3 Issuing Card in Batches.....	79
5.3.4 Exporting User Information.....	80
5.4 Permission Configuration.....	80
5.4.1 Adding Permission Group.....	80
5.4.2 Configuring Permission .....	82
5.5 Access Management.....	83
5.5.1 Remotely Opening and Closing Door.....	83
5.5.2 Setting Always Open and Always Close.....	84
5.5.3 Resetting Door Status .....	84
5.6 Attendance Management .....	85
5.6.1 Report Search.....	85
5.6.2 Other Configurations .....	86
<b>6 FAQ .....</b>	<b>87</b>
<b>Appendix 1 Notes of Face Recording/Comparison .....</b>	<b>88</b>
<b>Appendix 2 Cybersecurity Recommendations .....</b>	<b>91</b>

# 1 Overview

## 1.1 Introduction

The access controller is an access control panel that supports unlock through faces, passwords, cards, and supports unlock through their combinations.

## 1.2 Features

- LCD display, the resolution of 4.3-inch access controller is 480 × 272.
- Support face unlock, IC card unlock, fingerprint unlock, and password unlock; unlock by period
- With face detection box; the largest face among faces that appear at the same time is recognized first; the maximum face size can be configured on the web
- 2MP wide-angle WDR lens; with auto/manual illuminator
- Face recognition distance is 0.3 m–1.5 m
- With face recognition algorithm, the access controller can recognize more than 360 positions on human face
- Face verification accuracy > 99.5%; low false recognition rate
- Support profile recognition; the profile angle is 0°–90°
- Support liveness detection
- Support duress alarm, tamper alarm, intrusion alarm, door contact timeout alarm, illegal card exceeding threshold alarm, illegal password exceeding threshold alarm and external alarm
- Support general users, patrol users, blacklist users, VIP users, guest users, special users, and custom users
- Various unlock status display modes protect user privacy

## 1.3 Application

The access controller is applicable for parks, office buildings, schools, factories, residential areas and other places. The identity is verified through face recognition to achieve passage without perception.

Figure 1-1 Networking

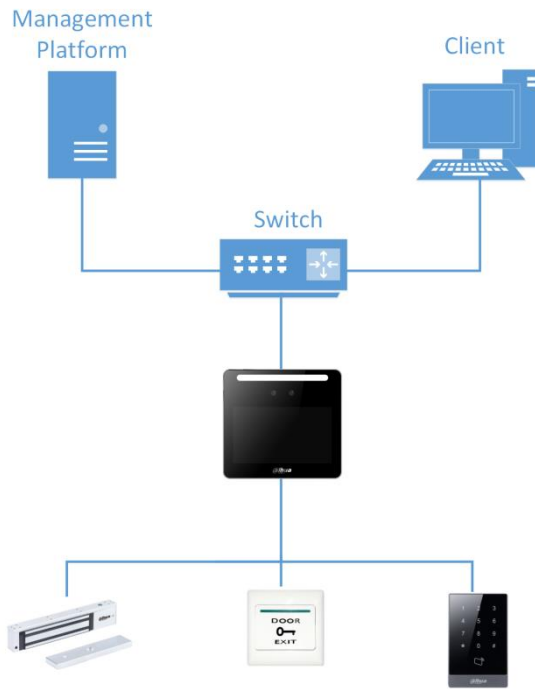

## 1.4 Dimension and Component

Figure 1-2 Dimensions and components of model G (mm [inch])

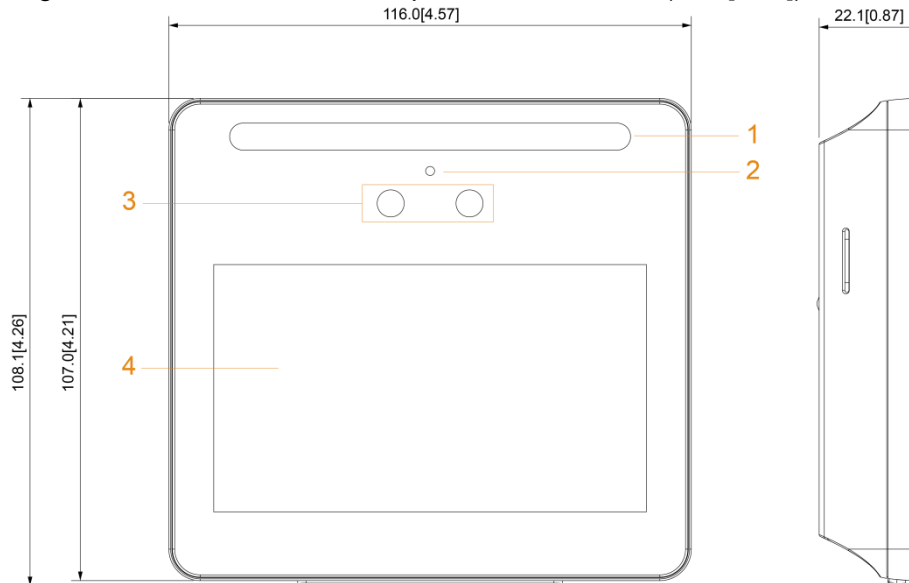

Table 1-1 Component description

No.	Name	No.	Name
1	White LED illuminator	3	Dual cameras
2	Mic	4	Display

Figure 1-3 Dimensions and components of model J with fingerprint sensor (mm [inch])

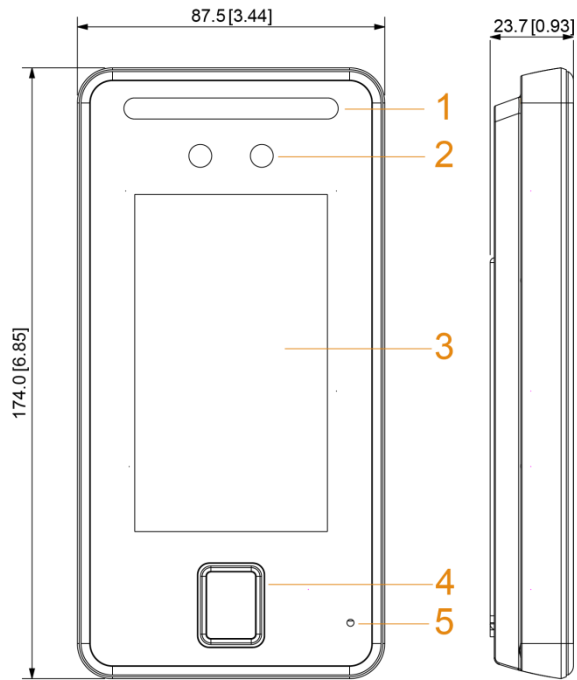

Table 1-2 Component description

No.	Name	No.	Name
1	White LED illuminator	3	Display
2	Dual cameras	4	Fingerprint sensor
5	Mic	—	—

Figure 1-4 Dimensions and components of model J without fingerprint sensor (mm [inch])

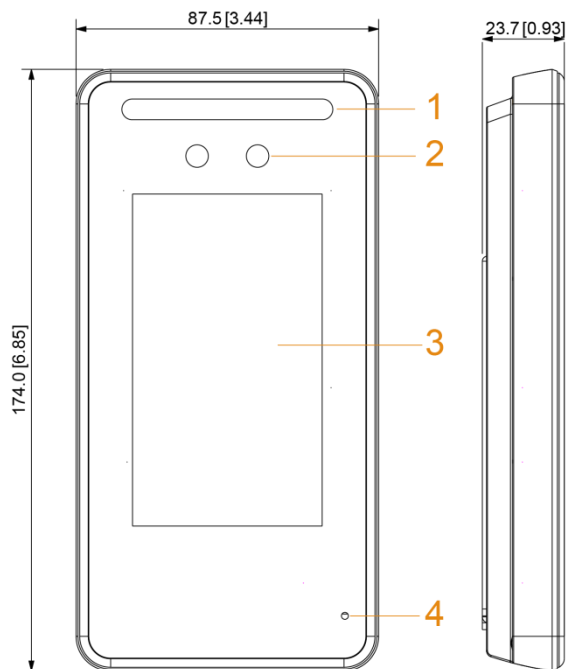

Table 1-3 Component description

No.	Name	No.	Name
1	White LED illuminator	3	Display
2	Dual cameras	4	Mic

# 2 Connection and Installation

## 2.1 Cable Connections

- Check whether the access control security module is enabled in **Function > Security Module**. If enabled, you need to purchase access control security module separately. The security module needs separate power supply.
- Once the security module is enabled, the exit button, turnstile control, and firefighting linkage will be invalid.

### Cable Connection of Model G

Figure 2-1 Cable connection of model G

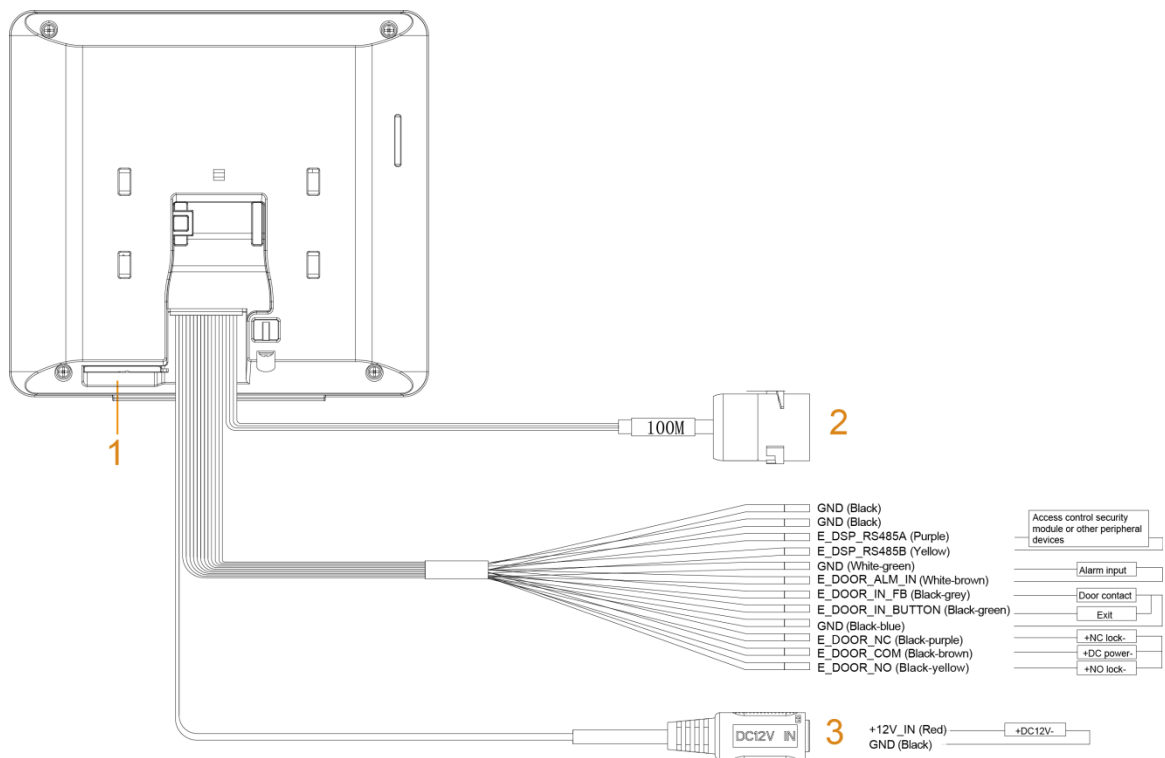



Figure 2-2 Ports of model G

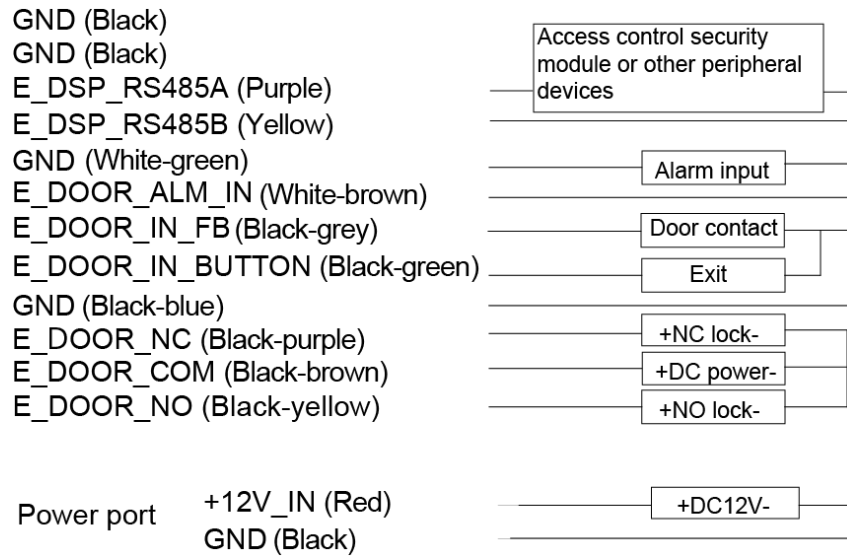

Table 2-1 Component description (1)

No.	Name
1	USB port
2	100M network port
3	Power port

# Cable Connection of Model J

Figure 2-3 Cable connection of model J

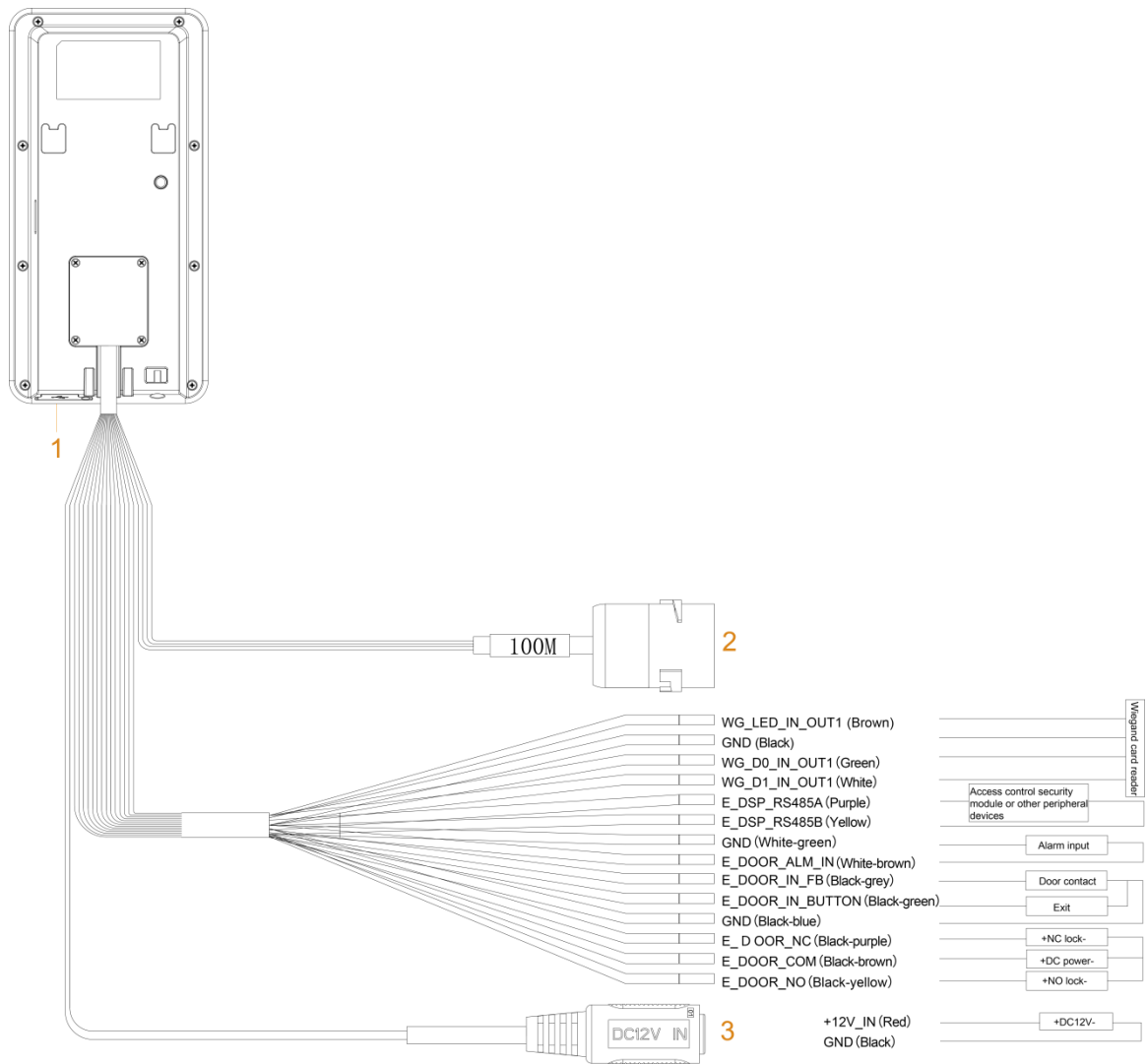

Figure 2-4 Ports of model J

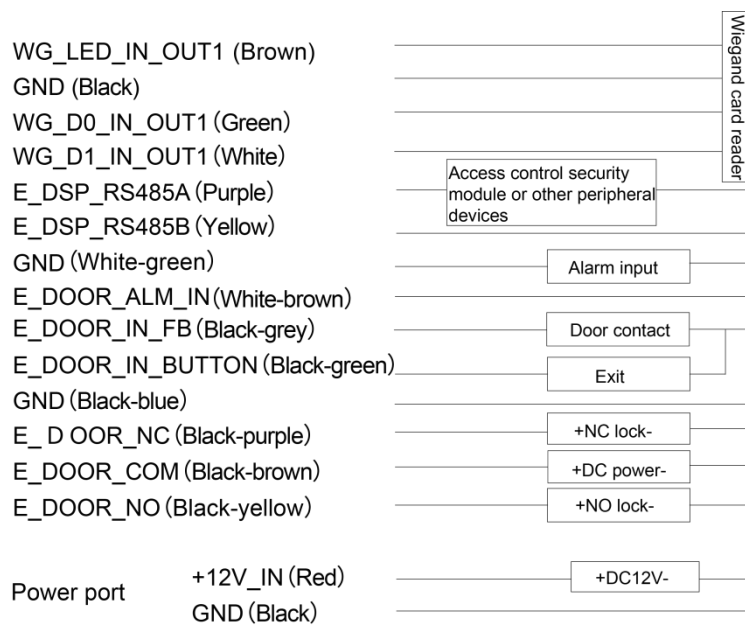

Table 2-2 Component description (2)

No.	Name
1	USB port
2	100M network port
3	Power port

## 2.2 Installation Notes



- If there is light source 0.5 meters away from the access controller, the minimum illumination should be no less than 100 Lux.
- It is recommended that the access controller is installed indoors, at least 3 meters away from windows and doors and 2 meters away from lights.
- Avoid backlight and direct sunlight.

### Ambient Illumination Requirement

Figure 2-5 Ambient illumination requirement



Candle: 10Lux



Light bulb: 100Lux–850Lux



Sunlight:  $\geq 1200\text{Lux}$

### Places Recommended

Figure 2-6 Places recommended

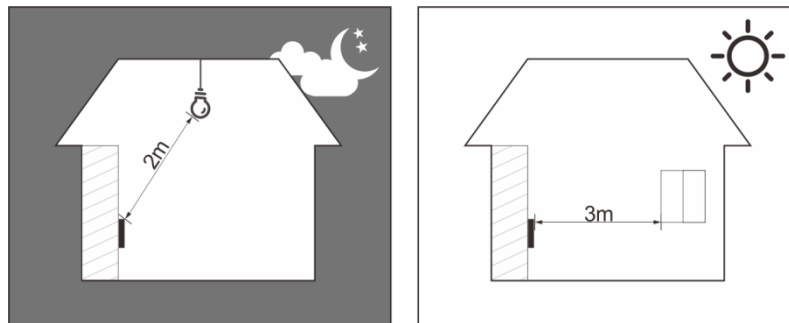

## Places Not Recommended

Figure 2-7 Places not recommended

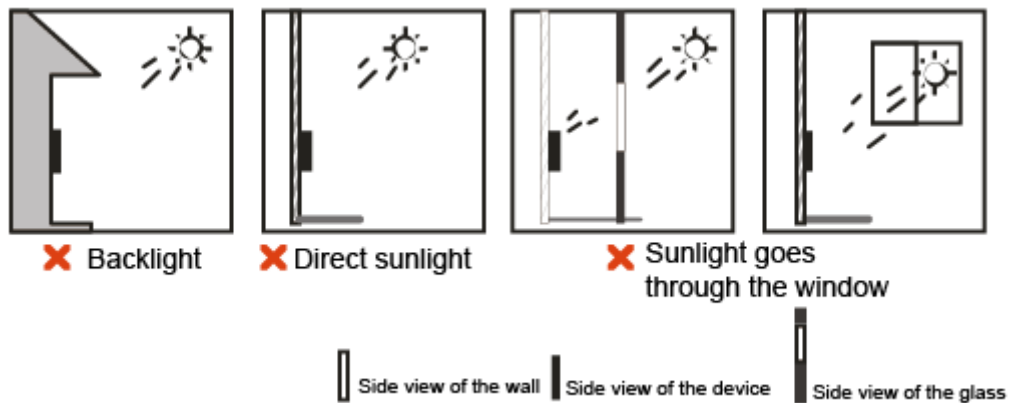

## 2.3 Installation

### 2.3.1 Installation of Model G

#### Desktop Installation

Insert the buckle of the desktop bracket into the rear slot of the access controller, and then slide it down to the end.

Figure 2-8 Desktop installation (1)

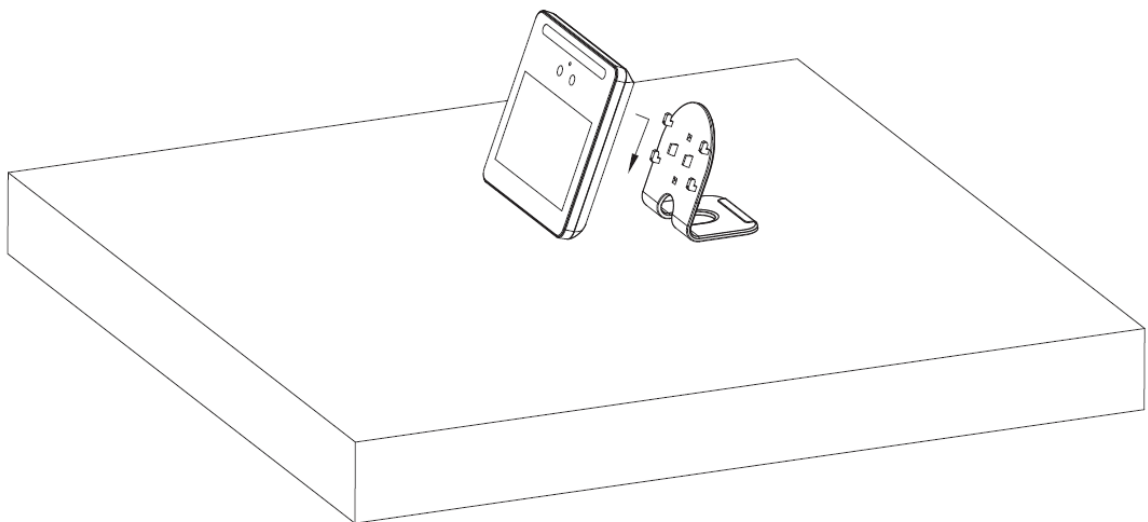
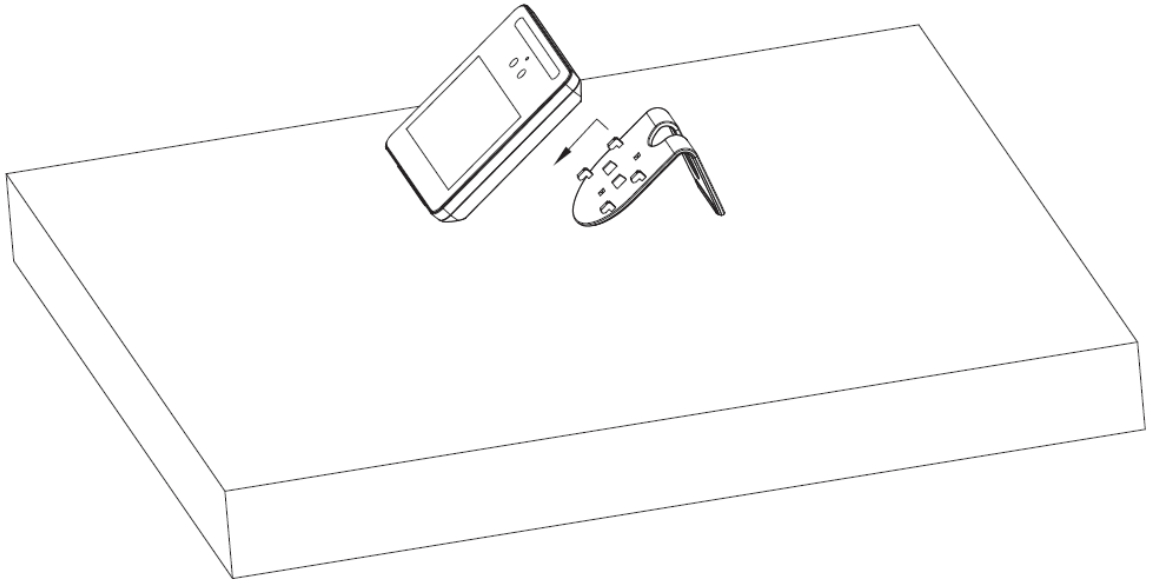

Figure 2-9 Desktop installation (2)



## Wall Installation

The recommended distance between the lens and ground is 1.4–1.6 meters.

Figure 2-10 Installation height

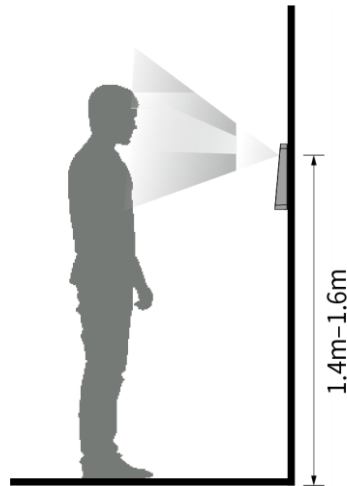
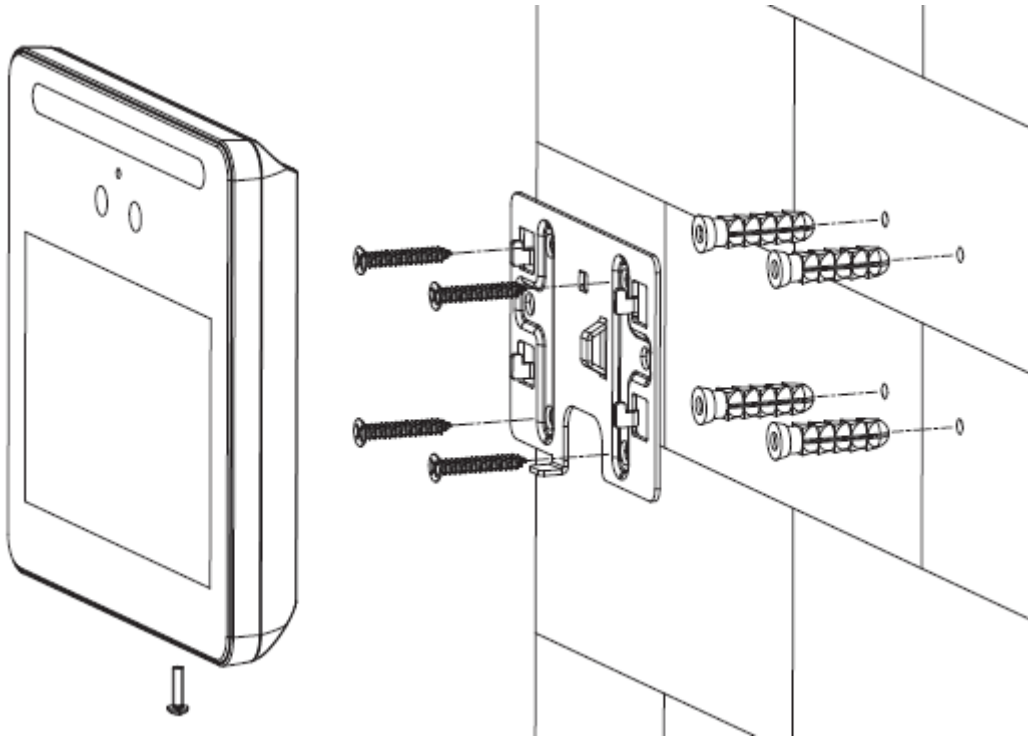

Figure 2-11 Wall installation



- Step 1 Drill four holes in the wall according to holes in the bracket.
- Step 2 Fix the bracket on the wall by installing the expansion screws into the four bracket installation holes.
- Step 3 Connect cables for access controller. See "2.1 Cable Connections".
- Step 4 Hang the access controller on the bracket hook.
- Step 5 Tighten the screws at the bottom of the access controller.

## 2.3.2 Installation of Model J

The recommended distance between the lens and ground is 1.4 meters.

Figure 2-12 Installation height

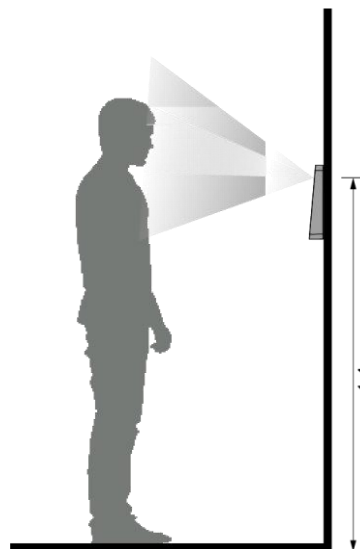

Figure 2-13 Wall installation

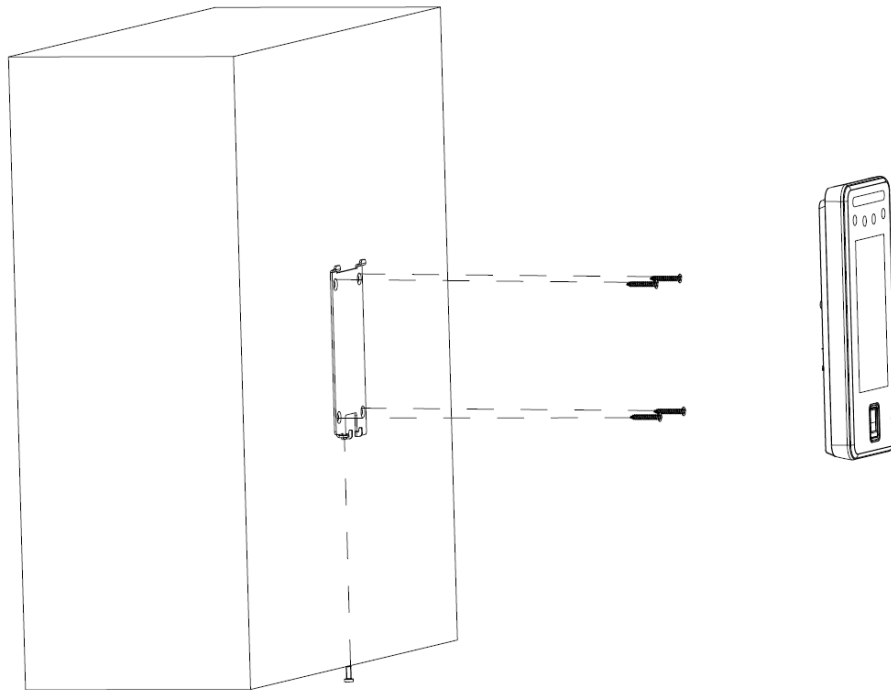
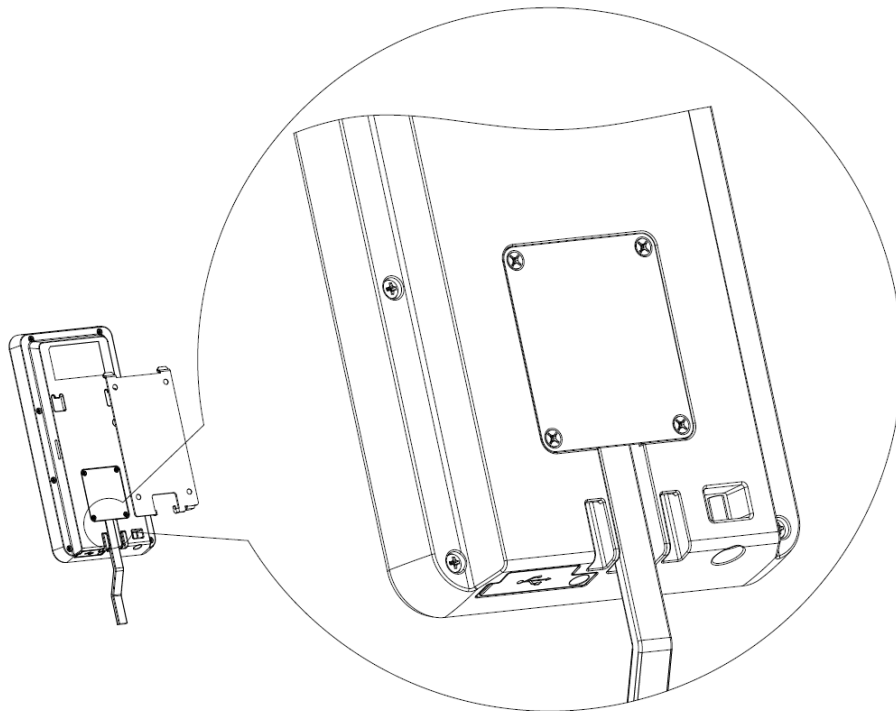

Figure 2-14 Applying silicon sealant to the access controller



## Installation Procedure

- Step 1 Drill four holes in the wall according to holes in the bracket.
- Step 2 Fix the bracket on the wall by installing the expansion screws into the four bracket installation holes.
- Step 3 Connect cables for access controller. See "2.1 Cable Connections".
- Step 4 Apply silicon sealant to gaps of the cable entry for waterproof. See Figure 2-14.
- Step 5 Hang the access controller on the bracket hook.
- Step 6 Tighten the screws at the bottom of the access controller.

Step 7 Apply silicon sealant to gaps between the wall and the access controller.



# 3 System Operations

## 3.1 Basic Configuration Procedure

Figure 3-1 Basic configuration procedure

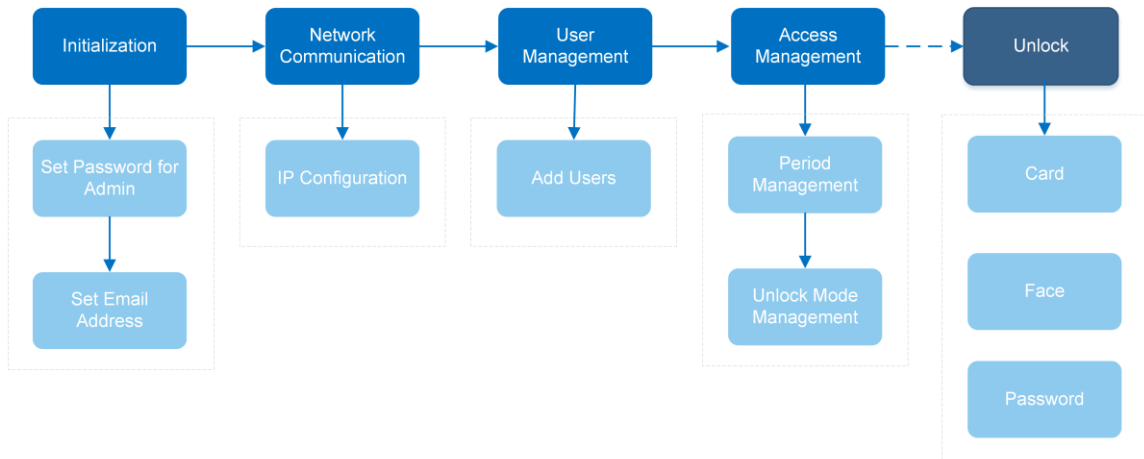

## 3.2 Common Icons

Table 3-1 Icon description

Icon	Description
	Confirm icon.
	Turn to the first page of the list.
	Turn to the last page of the list.
	Turn to the previous page of the list.
	Turn to the next page of the list.
	Return to the previous menu.
	Enable.
	Disable.
	Turn to previous page.
	Turn to next page.

## 3.3 Initialization

Administrator password and an email should be set the first time the access controller is turned on or after reset; otherwise the access controller cannot be used.

Figure 3-2 Initialization

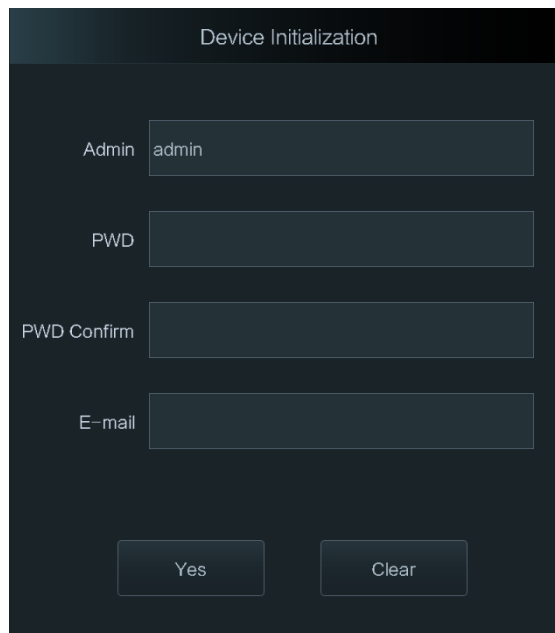

The screenshot shows a dark-themed web interface titled "Device Initialization". It features four input fields stacked vertically: "Admin" (containing "admin"), "PWD", "PWD Confirm", and "E-mail". At the bottom of the form are two buttons labeled "Yes" and "Clear".



- Administrator and password set on this interface are used to log in to the web management platform.
- The administrator password can be reset through the email address you entered if the administrator forgets the password.
- The password must consist of 8 to 32 non-blank characters and contain at least two types of characters among upper case, lower case, number, and special character (excluding ' " ; : & ).

## 3.4 Standby Interface

You can unlock the door through faces, passwords and cards.



- If there are no operations in 30 seconds, the access controller will go to the standby mode.
- The standby interface might vary with versions, and the actual interface shall prevail.

Figure 3-3 Standby interface of model J

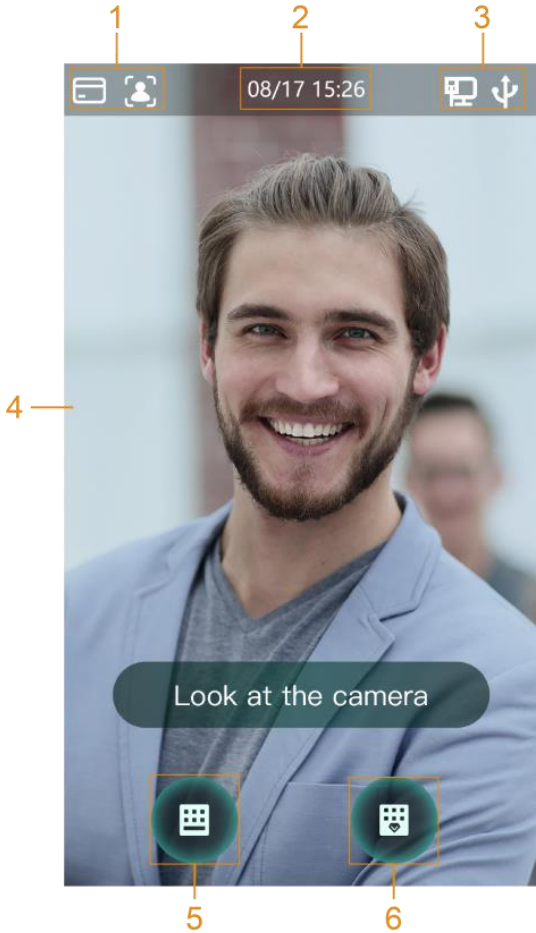

Figure 3-4 Standby interface of model G

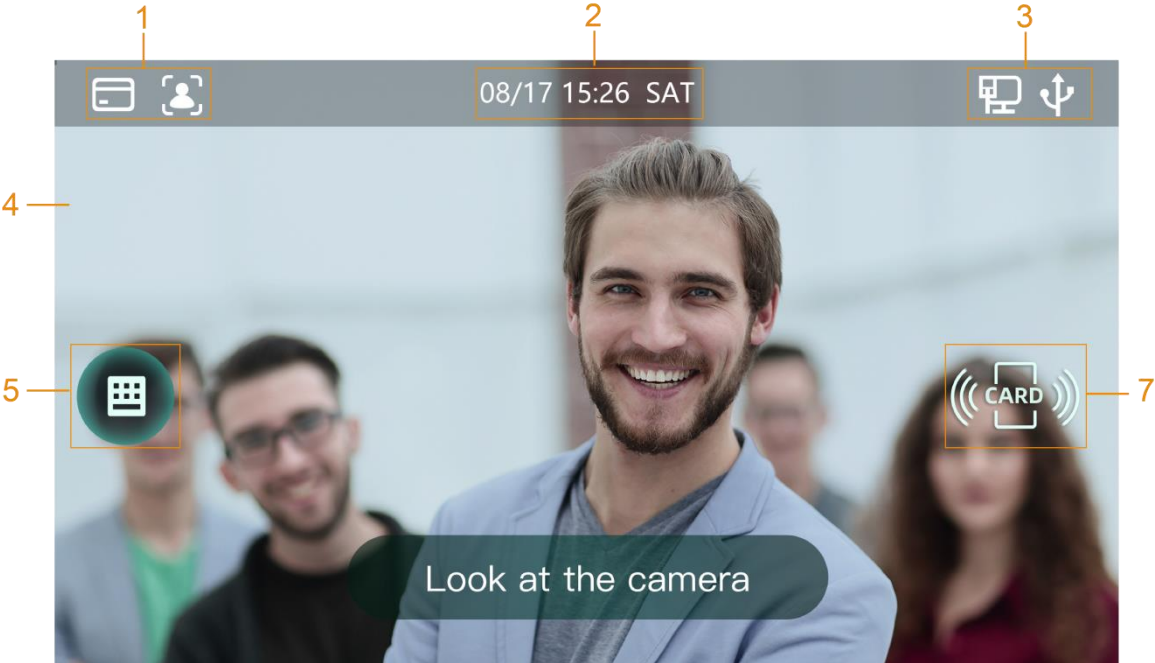



Table 3-2 Homepage description

No.	Description
-----	-------------

1	<p>Unlock methods: Card, face, fingerprint and password.</p>  <p>When card, face, fingerprint and password are all set as unlock mode, the password icon will not be displayed at the top left corner of the access controller.</p>
2	Date & Time. Displays the current date and time.
3	Display the network status and USB status.
4	Face recognition area.
5	Password unlock icon.
6	Administrator password unlock icon.
7	Card swiping area.

## 3.5 Main Menu

Administrators can add users of different levels, set access-related parameters, do network configuration, view access records and system information, and more in the main menu.

**Step 1** On the standby interface, long press 3 s to go to the **Administrator Login** interface.

**Step 2** Select a main menu entering method.



Different modes support different unlock methods, and the actual interface shall prevail.

Figure 3-5 Administrator login

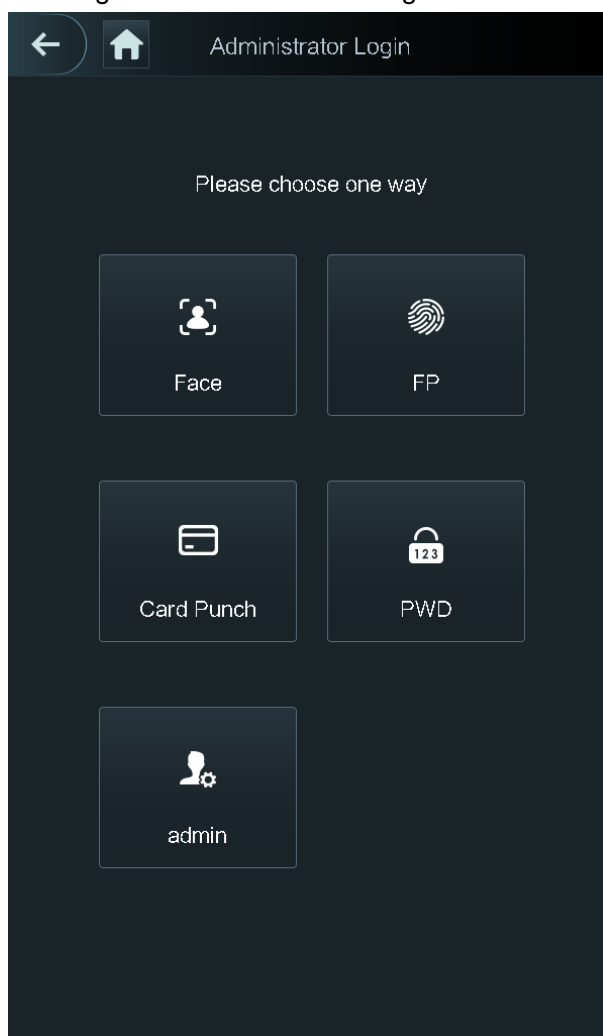

The main menu interface is displayed.

Figure 3-6 Main menu

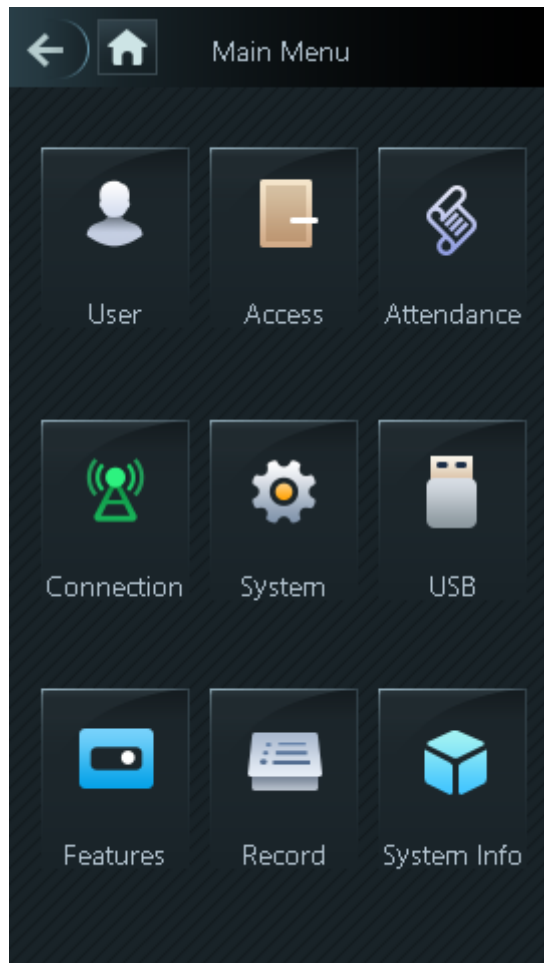

## 3.6 Unlocking Methods

You can unlock the door through faces, passwords, fingerprint and cards.

### 3.6.1 Cards

Put the card at the card swiping area to unlock the door.

### 3.6.2 Face

Make sure that your face is centered on the face recognition frame, and then you can unlock the door.

### 3.6.3 Fingerprints

Place your fingerprint at the fingerprint sensor to unlock the door.

## 3.6.4 User Password

Enter the user password, and then you can unlock the door.

Step 1 Tap  on the homepage.

Step 2 Tap **PWD Unlock**.

Step 3 Enter the user ID and password, and then tap .  
The door is unlocked.

## 3.6.5 Administrator Password

Enter the administrator password, and then you can unlock the door. There is only one administrator password for one access controller. The administrator password can unlock the door without being subject to user levels, unlock modes, periods, holiday plans, and anti-passback.



Administrator password cannot be used when NC is selected at "3.8.1.5 NC Period."

Step 1 Tap  on the homepage.

Step 2 Tap **Admin PWD**.

Step 3 Enter the administrator password, and then tap .  
The door is unlocked.

## 3.7 User Management

You can add new users, view user lists, admin lists, and modify the administrator password on the **User** interface.

### 3.7.1 Adding New Users

You can add new users by entering user IDs, names, face images, cards, passwords, selecting user levels, and more.



The following figures are for reference only, and the actual interface shall prevail.

Step 1 Log in to the **Main Menu** interface.

Step 2 Select **User > New User**.

Figure 3-7 New User Info

The screenshot shows a 'New User' configuration screen with a dark background. At the top, there are two navigation bars, each with a back arrow, the text 'New User', and a checkmark icon. The main area contains several rows of parameters and their values:



- User ID: 3
- User Level: General
- Name: (empty field)
- FP: 0
- Face: 0
- Card: 0
- PWD: (empty field)
- User Level: User
- Period: 255-Default
- Holiday Plan: 255-Default
- Valid Date: 2037-12-31

At the bottom, there are navigation arrows and page indicators: '<' 1/2 '>' and '<' 2/2 '>'.

**Step 3** Configure parameters on the interface.

Table 3-3 New user parameter description

Parameter	Description
User ID	Enter user IDs. The IDs can be numbers, letters, and their combinations, and the maximum length of the ID is 32 characters. Each ID is unique.
Name	Enter names with at most 32 characters (including numbers, symbols, and letters).
FP	<p>At most three fingerprints of one user can be recorded, and one fingerprints need to be verified three times.</p> <p>You can enable the Duress FP function under each fingerprint, and only one of the three fingerprints can be the duress fingerprint. Alarms will be triggered if a duress fingerprint is used to unlock the door.</p> <p></p> <ul style="list-style-type: none"> <li>It is not recommended that you select the first fingerprint as the duress fingerprint.</li> <li>Fingerprint unlock is only supported by access controllers with fingerprint sensors.</li> </ul>
Face	Make sure that your face is centered on the picture capturing frame and the access controller will take a picture of the new user's face automatically.

Card	<p>You can register five cards at most for each user. On the card registration interface, enter your card number or swipe your card, and then the card information will be read by the access controller.</p> <p>You can enable the <b>Duress Card</b> function on the card registration interface. Alarms will be triggered if a duress card is used to unlock the door.</p>  <p>Only certain models support card unlock.</p>
PWD	<p>The door unlocking password. The maximum length of the password is 8 digits.</p>  <p>If the access controller is without touch screen, you need to connect the access controller to a peripheral card reader. There are buttons on the card reader.</p>
User Level	<p>You can select a user level for new users. There are two options:</p> <ul style="list-style-type: none"> <li>• User: Users only have door unlock permission.</li> <li>• Admin: Administrators can unlock the door and also have parameter configuration permission.</li> </ul>  <p>No matter whether there is an administrator in the access controller, administrator identity authentication is needed.</p>
Period	You can set a period in which the user can unlock the door.
Holiday Plan	You can set a holiday plan in which the user can unlock the door.
Valid Date	You can set a period during which the unlocking information of the user is valid.
User Level	<p>There are six levels:</p> <ul style="list-style-type: none"> <li>• General: General users can unlock the door normally.</li> <li>• Blacklist: When users in the blacklist unlock the door, service personnel will get a prompt.</li> <li>• Guest: Guests are allowed to unlock the door certain times. Once they exceed the maximum times, they cannot unlock the door again.</li> <li>• Patrol: Paroling users can get their attendance tracked, but they have no unlock permission.</li> <li>• VIP: When VIP unlocks the door, service personnel will get a prompt.</li> <li>• Special: When special people unlock the door, there will be a delay of 5 seconds before the door is closed.</li> <li>• Custom User 1: Reserved for customization. Users can unlock the door normally.</li> <li>• Custom User 2: Reserved for customization. Users can unlock the door normally.</li> </ul>
Use Time	When the user level is Guest, you can set the maximum number of times that the user can unlock the door.

Step 4 Tap  to save the configuration.

### 3.7.2 Viewing User information

You can view user list, admin list and enable administrator password through the User interface.



## 3.8 Access Management

You can do access management on period, unlock mode, alarm, door status, and lock holding time.

Tap **Access** to go to the access management interface.

### 3.8.1 Period Management

You can set periods, holiday periods, holiday plan periods, door normally on periods, door normally closed periods, and remote verification periods.

#### 3.8.1.1 Period Config



For model G access controllers, you can configure periods locally; for model J access controllers, you can configure periods through web interface.

You can configure 128 periods (weeks) whose number range is 0–127. You can set four periods on each day of a period (week). Users can only unlock the door in the periods that you set.

#### 3.8.1.2 Holiday Group



For model G access controllers, you can configure holiday groups locally; for model J access controllers, you can configure holiday groups through web interface.

You can set group holidays, and then you can set plans for holiday groups. You can configure 128 groups whose number range is 0–127. You can add 16 holidays into a group. Configure the start time and end time of a holiday group, and then users can only unlock the door in the periods that you set.



You can enter names with 32 characters (including numbers, symbols, and letters). Tap  to save the holiday group name.

#### 3.8.1.3 Holiday Plan



For model G access controllers, you can configure holiday plans locally; for model J access controllers, you can configure holiday plans through web interface.

You can add holiday groups into holiday plans. You can use holiday plans to manage user access permission in different holiday groups. Users can only unlock the door in the period that you set.

### 3.8.1.4 NO Period

If a period is added to the NO period, then the door is normally open in that period.



The NO/NC period permissions are higher than permissions in other periods.

### 3.8.1.5 NC Period



If a period is added to the NC period, then the door is normally closed in that period. Users can not unlock the door in this period.

### 3.8.1.6 Remote Verification Period

If you configured the remote verification period, then when unlock doors during the period you configured, remote verification is required. To unlock the door in this period, a door unlock instruction sent by the management platform is needed.



You need to enable the Remote Verification Period.

-  means enabled.
-  means not enabled.

## 3.8.2 Unlock

There are three unlock modes: unlock mode, unlock by period, and group combination. Unlock modes vary with controller access models, and the actual controller access shall prevail.

### 3.8.2.1 Unlock Mode

When the **Unlock Mode** is on, users can unlock through cards, faces, passwords, or any one of all the unlocking methods.

Step 1 Log in to the **Main Menu** interface.

Step 2 Select **Access > Unlock Mode > Unlock Mode**.

Figure 3-8 Element (multiple choice)

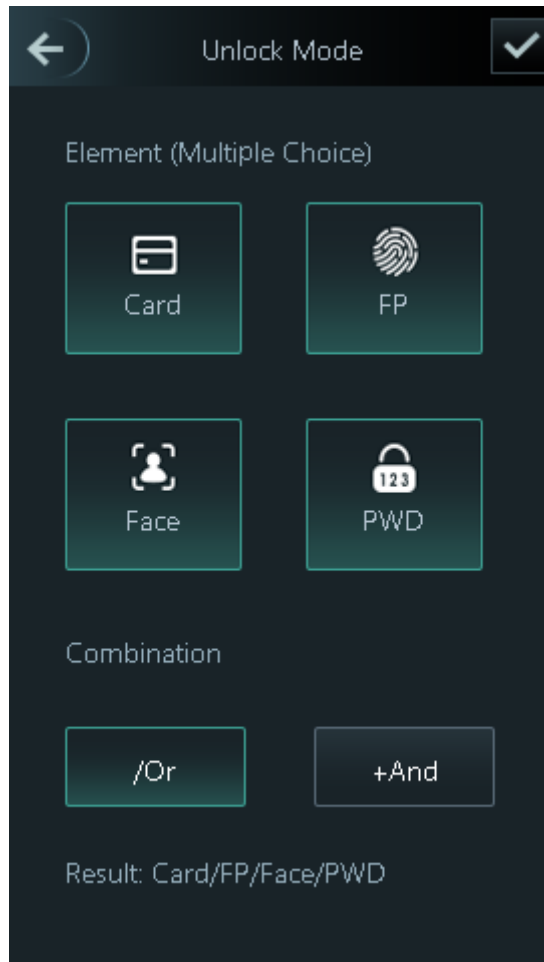

Step 3 Select unlock mode(s).



Tap a selected unlock mode again, the unlock mode will be deleted.



Step 4 Select a combination mode.

- **+ And** means "and". For example, if you select card + PWD, it means, to unlock the door, you need to swipe your card first, and then enter password.
- **/ Or** means "or". For example, if you select card/PWD, it means, to unlock the door, you can either swipe your card or enter password.

Step 5 Tap  to save the settings.

And then the **Unlock Mode** interface is displayed.

Step 6 Enable the Unlock Mode.

-  means enabled.
-  means not enabled.

### 3.8.2.2 Unlock by Period



For model G access controllers, you can configure unlock by periods locally; for model J access controllers, you can configure unlock by periods through web interface.

Doors can be unlocked through different unlock modes in different periods. For example, in period 1, the door can only be unlocked through cards; and in period 2, doors can only be unlocked through faces.

**Step 1** Log in to the **Main Menu** interface.

**Step 2** Select **Access > Unlock Mode > Unlock by Period**.



Figure 3-9 Unlock by period

**Step 3** Set starting time and end time for a period, and then select a unlock mode.

**Step 4** Tap  to save the settings.

The **Unlock Mode** interface is displayed.

**Step 5** Enable the Unlock by Period function.

-  means enabled.
-  means not enabled.

### 3.8.2.3 Group Combination



For model G access controllers, you can configure group combination locally; for model J access controllers, you can configure group combination through web interface.

Doors can only be unlocked by a group or groups that consist of more than two users if the Group Combination is enabled.

**Step 1** Log in to the **Main Menu** interface.

**Step 2** Select **Access > Unlock Mode > Group Combination**.

Figure 3-10 Group Combination

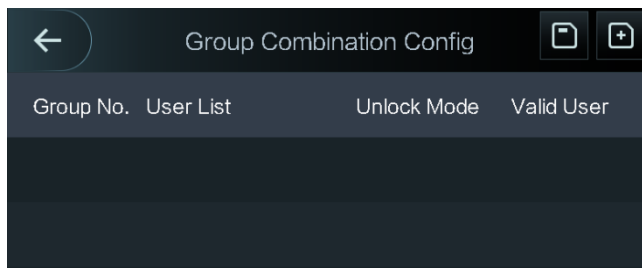

**Step 3** Tap  to create a group.

Figure 3-11 Add a group

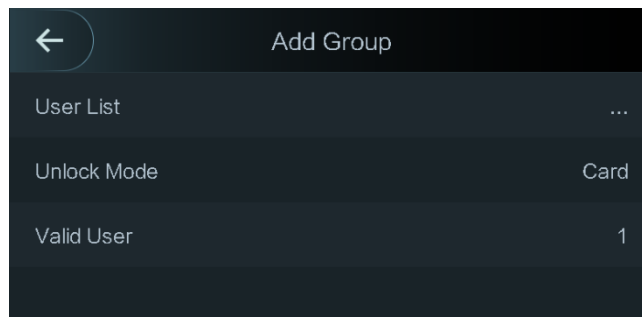





Table 3-4 Group parameter



Parameter	Description
User List	<p>Add users to the newly created group.</p> <ol style="list-style-type: none"> <li>1. Tap <b>User List</b>. The <b>User List</b> interface is displayed.</li> <li>2. Tap , and then enter a user ID.</li> <li>3. Tap  to save the settings.</li> </ol>
Unlock Mode	There are three options: <b>Card</b> , <b>PWD</b> and <b>Face</b> .

Valid User	<p>Valid users are the ones that have unlock permission. Doors can be unlocked only when the number of users to unlock the doors equals the valid user number.</p> <ul style="list-style-type: none"> <li>• Valid users cannot exceed the total number of users in a group.</li> <li>• If valid users equal total user numbers in a group, doors can only be unlocked by all the users in the group.</li> <li>• If valid users are less than the total number of users in a group, doors can be unlocked by any users whose number equals the valid user number.</li> </ul>
------------	---

Step 4 Tap  to go back to the previous interface.

Step 5 Tap  to save the settings.

Step 6 Enable the Group Combination.

-  means enabled.
-  means not enabled.

### 3.8.3 Alarm Configuration

Administrators can manage visitors' unlock permission through alarm configuration.

Step 1 Log in to the **Main Menu** interface.

Step 2 Select **Access > Alarm**. The Alarm interface is displayed.

Figure 3-12 Alarm

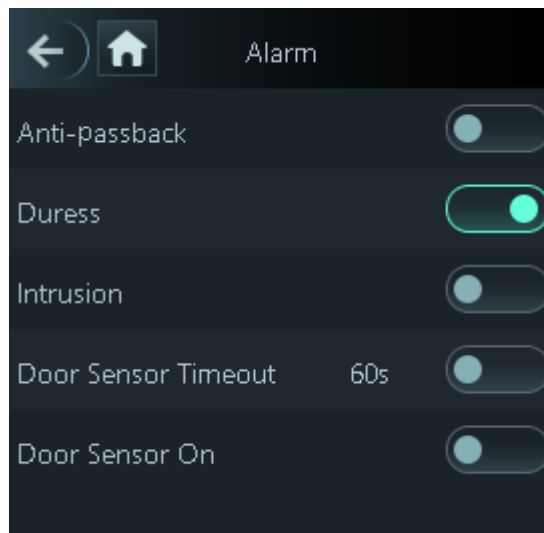



-  means enabled.
-  means not enabled.

Table 3-5 Parameters on the alarm interface

Parameter	Description
Anti-passback	<p>After the anti-passback is enabled, users need to verify identities both for entry and exit; otherwise an alarm will be triggered.</p> <ul style="list-style-type: none"> <li>• If a person enters with the identity checked and exits without the identity checked, an alarm will be triggered when the person tries to enter again and the person will have no permission to unlock the door any more.</li> <li>• If a person enters without the identity checked, an alarm will be triggered when the person tries to exit with the identity checked, and the person will have no permission to unlock the door any more.</li> </ul>
Duress	An alarm will be triggered when a duress card or duress password is used to unlock the door.
Illegal Card Exceeding Time	After an unauthorized card is used to unlock the door more than 5 times in 50 seconds, an alarm will be triggered.
Intrusion	An intrusion alarm will be triggered if a door is unlocked without having the door contact released.
Door Sensor Timeout	<p>A timeout alarm will be triggered if the time that a user takes to unlock the door exceeds the Door Sensor Timeout time.</p> <p>The Door Sensor Timeout time range is 1–9999 seconds.</p>
Door Sensor On	Only when the <b>Door Sensor On</b> is enabled can the intrusion alarm and door sensor timeout alarm be triggered.

### 3.8.4 Door Status

There are three options: **NO**, **NC**, and **Normal**.

- **NO**: If **NO** is selected, the door status is normally open, which means the door will never be closed.
- **NC**: If **NC** is selected, the door status is normally closed, which means the door will not be unlocked.
- **Normal**: If **Normal** is selected, the door will be unlocked and locked depending on your settings.

### 3.8.5 Lock Holding Time

**Lock Holding Time** is the duration in which the lock is unlocked. If the lock has been unlocked for a period that exceeds the duration, the lock will be automatically locked.

## 3.9 Attendance

You can enable attendance and set attendance mode.

There are 4 modes: Auto/Manual, Auto, Manual and Fixed.

There are 6 attendance statuses: Check In, Break Out, Break In, Check Out, OT-In, and OT-Out.

Step 1 Log in to the **Main Menu** interface.

Step 2 Tap **Attendance**, and then tap  to enable attendance.

Figure 3-13 Attendance



Step 3 Tap **Mode Set** to set attendance mode and time periods of different statuses.

- Auto/Manual Mode: Automatically display the attendance status according to the attendance time when you punch in or out on the standby interface. And you can also manually select an attendance status when you punch in or out on the standby interface.
- Auto Mode: Automatically display the attendance status according to the attendance time when you punch in or out on the standby interface.
- Manual Mode: You need to manually select an attendance status when you punch in or out on the standby interface.
- Fixed Mode: The attendance status is fixed when you punch in or out on the standby interface.

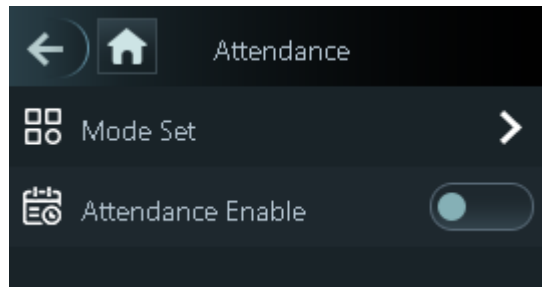
## 3.10 Network Communication

To make the access controller work normally, you need to configure parameters for network, serial ports and Wiegand ports.

### 3.10.1 IP Configuration

Configure an IP address for the access controller to make it be connected to the network.

Step 1 Log in to the **Main Menu** interface.

Step 2 Select **Connection > Network > IP Address**, and then configure IP address parameters.



Figure 3-14 IP address configuration

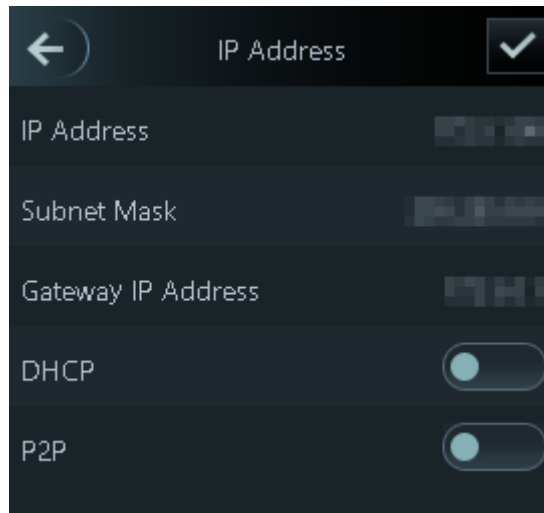



Table 3-6 IP configuration parameters

Parameter	Description
IP Address/Subnet Mask/Gateway IP Address	The IP address, subnet mask, and gateway IP address should be on the same network segment. After configuration, tap  to save the configurations.
DHCP	DHCP (Dynamic Host Configuration Protocol). When the DHCP is enabled, the IP address can be automatically acquired, and the IP address, subnet mask and gateway IP address cannot be manually configured.
P2P	P2P is a private network traversal technology which enables user to manage devices without requiring DDNS, port mapping or transit server.



Make sure that the computer used to log in to the web is in the same LAN with the device.

### 3.10.2 Active Register

By active registering, you can connect the access controller to the management platform, and then you can manage the access controller through the management platform.



Configurations you have made can be cleared on the managing platform, and the access controller can be initialized, you need to protect the platform managing permission in case of data loss caused by improper operation.

**Step 1** Log in to the **Main Menu** interface.

**Step 2** Select **Connection > Network > Active Register**, and the **Active Register** is displayed.

**Step 3** Tap  to enable active register, and then configure parameters.

Table 3-7 Active register

Name	Parameter
Server IP Address	IP address of the managing platform.
Port	Port number of the managing platform.
Device ID	Subordinate device number on the managing platform.

### 3.10.3 Wi-Fi

You can connect the access controller to the network through Wi-Fi if the access controller has Wi-Fi function.

Step 1 Log in to the **Main Menu** interface.

Step 2 Select **Connection > Network > WiFi**, and the **WiFi** interface is displayed.

Step 3 Tap  to enable Wi-Fi, and then configure Wi-Fi related parameters.

Figure 3-15 Wi-Fi



### 3.10.4 Serial Port Settings

Select serial input or serial output according to the use of the external devices.

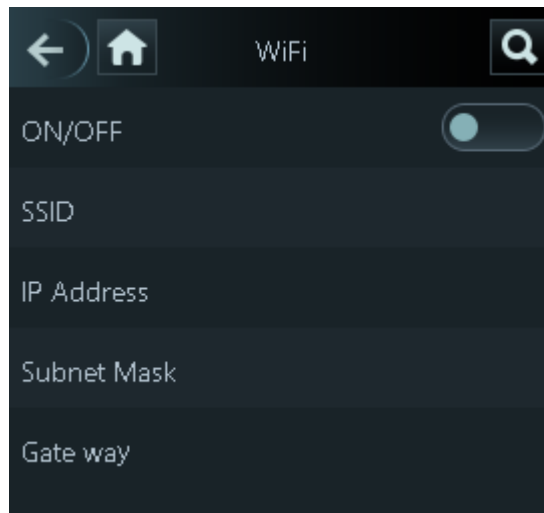
Step 1 Log in to the **Main Menu** interface.

Step 2 Select **Connection > Serial Port**, and then the **Serial Port** interface is displayed.

Figure 3-16 Serial port

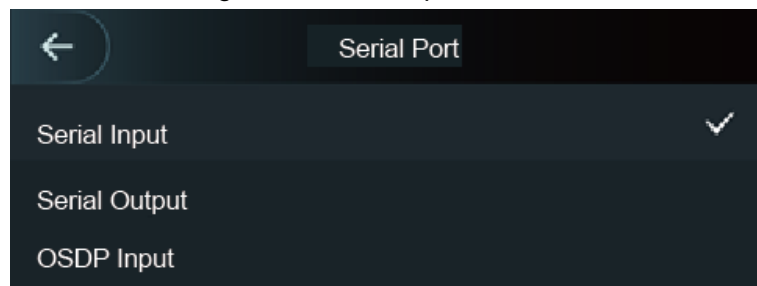

- Select **Serial Input** when external devices that are with card reading and writing functions are connected to the access controller. **Serial Input** is selected to enable access card information to be sent to the access controller and the management platform.

- For access controllers with face recognition, card reading and writing functions, if you select **Serial Output**, access controller will send lock/unlock information to the access controller. There are two types of lock/unlock information:
  - ◇ User ID
  - ◇ Card No.
- Select OSDP Input when card reader of OSDP protocol is connected to the access controller. The access controller can send card information to the management platform.

### 3.10.5 Wiegand Configuration



Only model J access controllers support this function.

Select **Wiegand Input** or **Wiegand Output** accordingly.

Step 1 Log in to the **Main Menu** interface.

Step 2 Select **Connection > Wiegand**, and then the **Wiegand** interface is displayed.

Figure 3-17 Wiegand

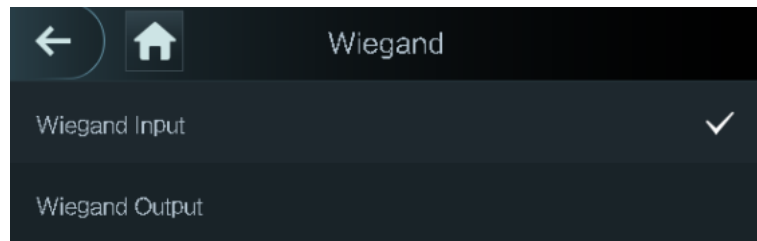

- Select **Wiegand Input** when an external card swipe mechanism is connected to the access controller.
- Select **Wiegand Output** when the access controller works as a reader that can be connected to the controller. See Table 3-8.

Table 3-8 Wiegand output

Parameter	Description
Wiegand Output Type	<p>The <b>Wiegand Output Type</b> determines the card number or the digit of the number that can be recognized by the access controller.</p> <ul style="list-style-type: none"> <li>• Wiegand26, three bytes, six digits.</li> <li>• Wiegand34, four bytes, eight digits.</li> <li>• Wiegand66, eight bytes, sixteen digits.</li> </ul>
Pulse Width	You can set pulse width and pulse interval.
Pulse Interval	
Output Data Type	<p>You can select the types of output data.</p> <ul style="list-style-type: none"> <li>• User ID: If User ID is selected, and then user ID will be output.</li> <li>• Card No.: If Card No. is selected, and then card number will be output.</li> </ul>

## 3.11 System

### 3.11.1 Time

You can do date format setting, date setting, time setting, DST setting, NTP check, and time zone settings.

Step 1 Log in to the **Main Menu** interface.

Step 2 Select **System > Time**, and then configure time parameters.

Figure 3-18 Time

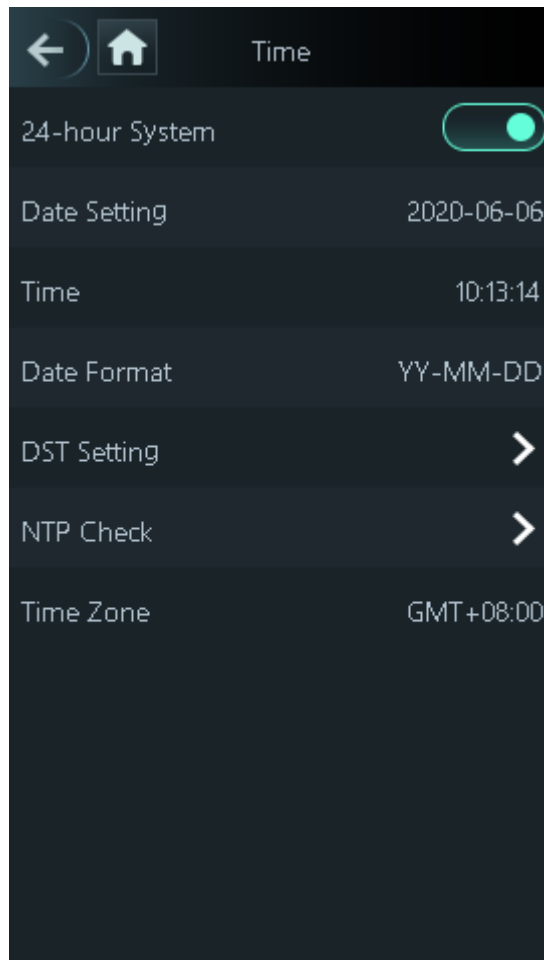

- When you select **Network Time Protocol (NTP)**, you need to enable the NTP Check function first. Server IP Address: enter the IP address of the time server, time of the access controller will be synchronized with the time server.
- Port: Enter the port number of the time server.
- Interval (min): NPT check interval. Tap the save icon to save.

### 3.11.2 Face Parameter

Step 1 Log in to the **Main Menu** interface.

Step 2 Select **System > Face Parameter**, and then the **Face Parameter** interface is displayed.

Figure 3-19 Face parameter



Step 3 Tap a parameter and do configuration, and then tap .

Table 3-9 Face parameters

Parameter	Description
Face Threshold	Face recognition accuracy can be adjusted. The larger the value is, the higher the accuracy will be.
Max. Angle of Face	Set the control panel shooting angle of profiles. The larger the value is, the wider range of the profiles will be recognized.
Pupillary Distance	Pupillary distance is the pixel value of the image between the centers of the pupils in each eye. You need to set an appropriate value so that the access controller can recognize faces as needed. The value changes according to the face sizes and the distance between faces and the lens. The closer the face is to the lens, the greater the value should be. If an adult is 1.5 meters away from the lens, the pupillary distance value can be within 50 to 70.
Recognition Timeout	The interval of the prompt during valid face recognition.
Prompt Interval	The interval of the prompt during invalid face recognition.
Anti-fake Threshold	This function prevents people from unlocking by human face images or face models. The larger the value is, the more difficult face images can unlock the door. The recommended value range is above 80.

### 3.11.3 Image Mode

There are three options:

- Indoor: Select **Indoor** when the access controller is installed indoors;
- Outdoor: Select **Outdoor** when the access controller is installed outdoors;
- Other: Select **Other** when the access controller is installed at places with backlights like corridors and hallways.



### 3.11.4 Volume Adjustment

Tap  or  to adjust the volume.

### 3.11.5 Language Setting

The following languages are available: English, Italian, Spanish, Russian, Turkish, Polish, Arabic, Spanish (Latin America), and Thai.

### 3.11.6 Infrared Light Brightness Adjustment

Tap  or  to adjust the infrared light brightness.

The larger the value is, the brighter the infrared light will be.

### 3.11.7 Screen Setting

You can set the screen saver time and screen off time.

Step 1 Log in to the **Main Menu** interface.

Step 2 Select **System > Screen Settings**, and the **Screen Settings** interface is displayed.

Figure 3-20 Screen settings

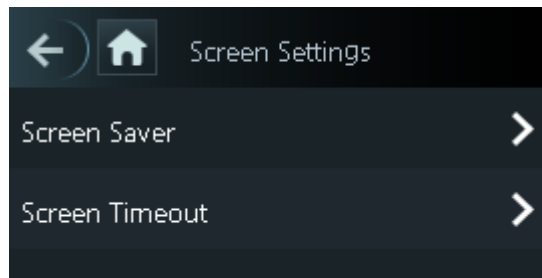

### 3.11.8 Restore to Factory Settings



- Data will be lost if you restore the access controller to the factory settings.
- After the access controller is restored to the factory settings, IP address will not be changed.

You can select whether to retained user information and logs.

- You can select to restore the access controller to the factory settings with all user information and device information deleted.
- You can select to restore the access controller to the factory settings with user information and device information retained.

## 3.11.9 Reboot

Step 1 Log in to the **Main Menu** interface.

Step 2 Select **System > Reboot**, and the access controller will be rebooted.

## 3.12 USB



- Make sure that the USB is inserted before exporting user information and updating. During exporting or updating, do not pull out the USB or do other operations; otherwise the exporting or updating will fail.
- You need to import information from one access controller to the USB before using USB to import information to another access controller.
- USB can also be used to update the program.

### 3.12.1 USB Export

You can export data from the access controller to the USB after inserting the USB. The data exported is encrypted and cannot be edited.

Step 1 Log in to the **Main Menu** interface.

Step 2 Select **USB > USB Export**.

The **USB Export** interface is displayed.

Figure 3-21 USB export

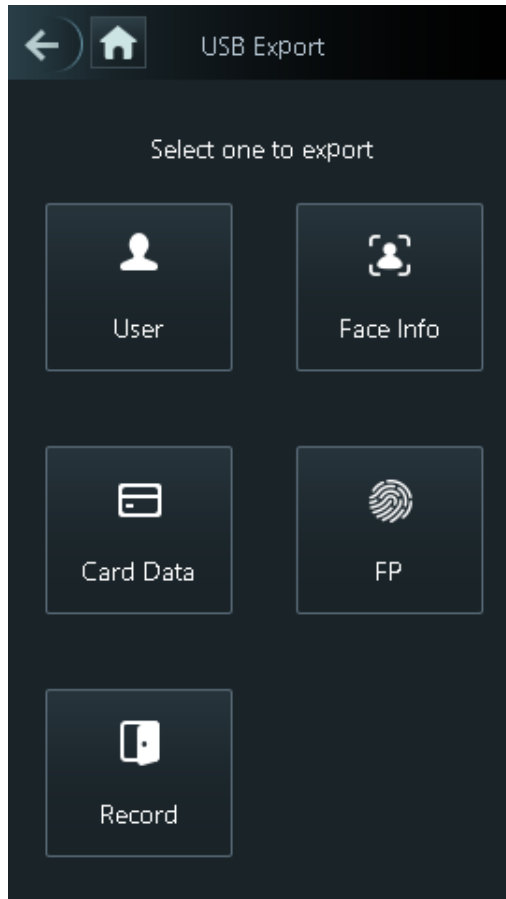

**Step 3** Select the data type that you want to export.  
The prompt Confirm to export is displayed.

**Step 4** Tap **OK**.  
Data exported will be saved in the USB.

### 3.12.2 USB Import

Only data in the USB that was exported from one access controller can be imported into another access controller.

**Step 1** Log in to the **Main Menu** interface.

**Step 2** Select **USB > USB Import**.  
The **USB Import** interface is displayed.



Figure 3-22 USB Import

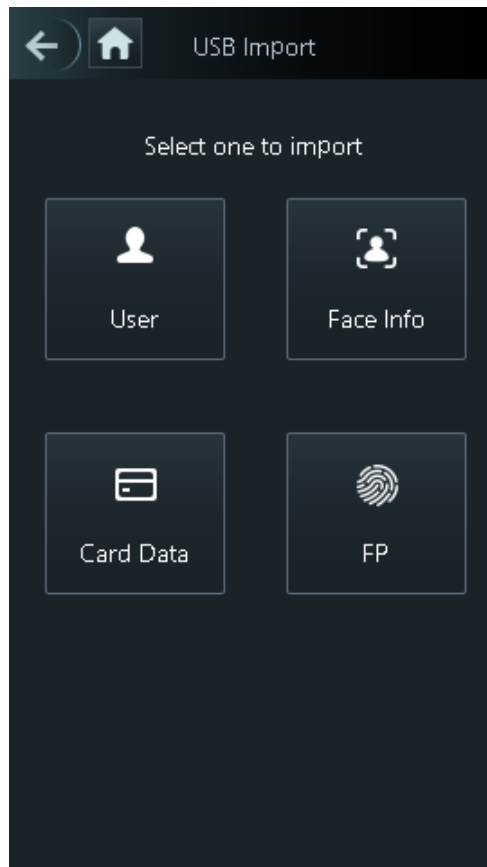

Step 3 Select the data type that you want to import.

The prompt **Confirm to import** is displayed.

Step 4 Tap **OK**.

Data in the USB flash drive will be imported into the access controller.

### 3.12.3 USB Update

USB flash drive can be used to update the system.

Step 1 Rename the updating file name to "update.bin", and save the "update.bin" file in the root directory of the USB flash drive.



Make sure that the computer used to log in to the web is in the same LAN with the device.

Step 2 Log in to the **Main Menu** interface.

Step 3 Select **USB > USB Update**.

The prompt **Confirm to Update** is displayed.

Step 4 Tap **OK**.

The update starts, and the access controller reboots after the update is finished.

## 3.13 Features

You can do settings about privacies, card number reverse, security module, door sensor type, and result feedback.

Step 1 Log in to the **Main Menu** interface.

Step 2 Tap **Features**, and then the **Features** interface is displayed.

Figure 3-23 Features

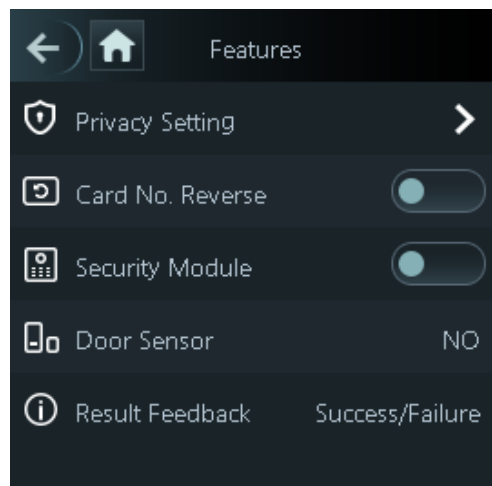

Table 3-10 Feature description

Parameter	Description
Privacy Setting	See "3.13.1 Privacy Setting" for details.
Security Module	<ul style="list-style-type: none"><li>• If the security module is enabled, you need to purchase access control security module separately. The security module needs separate power supply to provide power.</li><li>• Once the security module is enabled, the exit button, lock control and firefighting linkage will be invalid.</li></ul>
Door Sensor	There are two options: <b>NO</b> and <b>NC</b> .
Result Feedback	Select a result feedback mode during unlock. There are 4 result feedback modes: Success/Failure, Only Name, Photo&Name, and Photos&Name.

### 3.13.1 Privacy Setting

Figure 3-24 Privacy setting

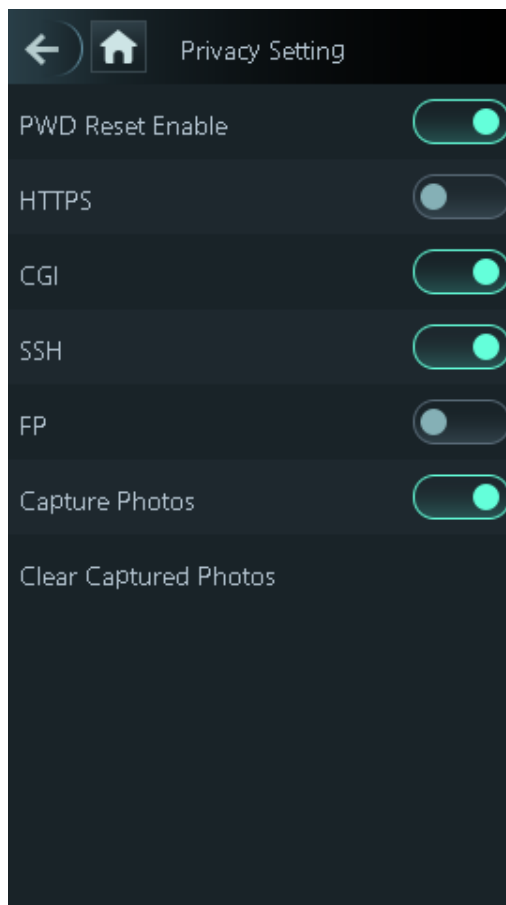



Table 3-11 Privacy setting

Parameter	Description
PWD Reset Enable	If the <b>PWD Reset Enable</b> function is enabled, you can reset the password. The PWD Reset function is enabled by default.
HTTPS	Hypertext Transfer Protocol Secure (HTTPS) is a protocol for secure communication over a computer network. When HTTPS is enabled, HTTPS will be used to access CGI commands; otherwise HTTP will be used.  When HTTPS is enabled, the access controller will restart automatically.
CGI	Common Gateway Interface (CGI) offers a standard protocol for web servers to execute programs that execute like console applications running on a server that generates web pages dynamically. When CGI is enabled, CGI commands can be used. The CGI is enabled by default.
SSH	Secure Shell (SSH) is a cryptographic network protocol for operating network services securely over an unsecured network. When SSH is enabled, SSH provides cryptographic service for the data transmission.

Capture photo	If you select ON, when a user unlocks the door, the user's photo will be automatically taken. This function is ON by default.
Clear all captured photos	Tap the icon, and you can delete all captured photos.

### 3.13.2 Result Feedback

There are 4 result feedback modes: Success/Failure, Only Name, Photo&Name, and Photos&Name.

You can select a result feedback mode as needed.

#### Photos&Name Mode

The captured face image, the image saved in the face database, user ID, user name and time are all displayed during unlock.

Figure 3-25 Photos&Name mode

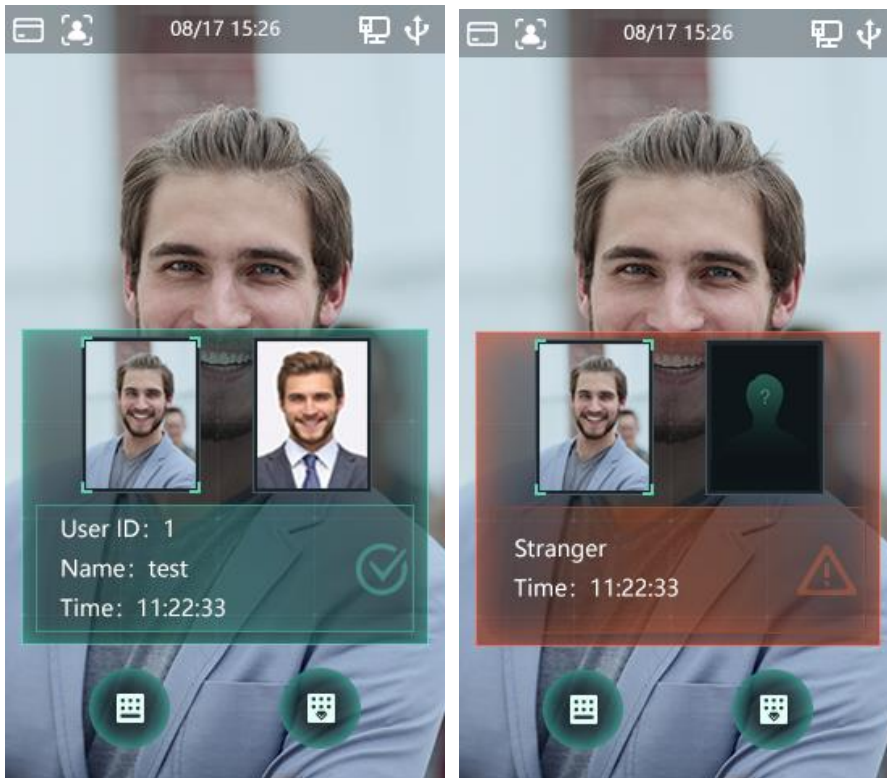

#### Photo&Name Mode

The image saved in the face database, user ID, user name and time are all displayed during unlock.

Figure 3-26 Photo&Name mode



### Only Name Mode

Only user ID, user name and time are displayed during unlock.

Figure 3-27 Only name mode



## Success/Failure Mode

Only display success or failure during unlock.

Figure 3-28 Success/Failure mode

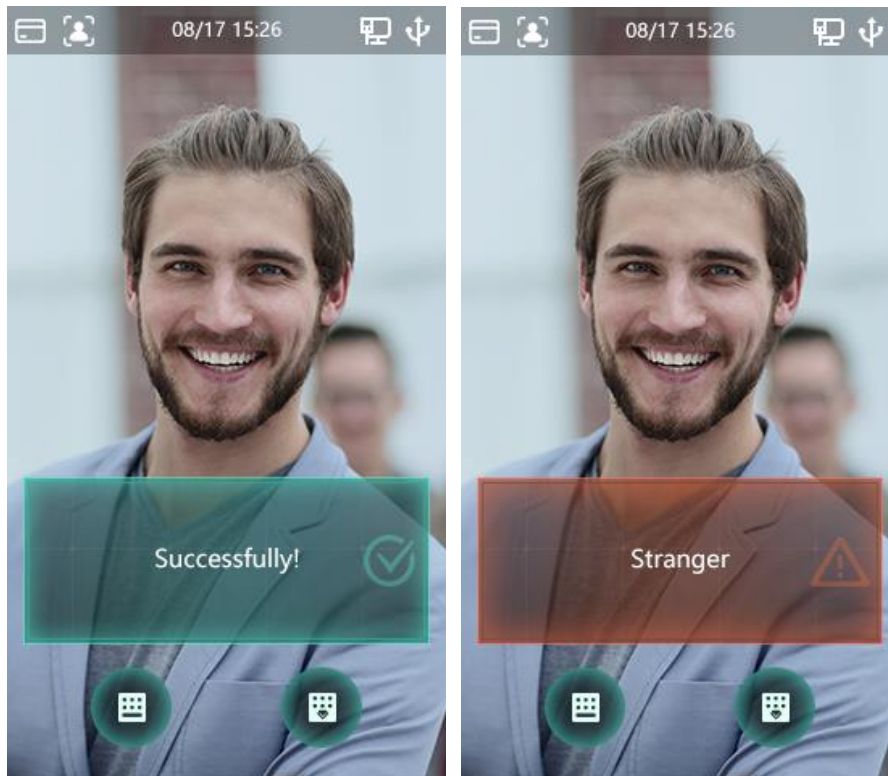

### 3.14 Record

You can query all unlocking records.

Figure 3-29 Search punch records



User ID.	Name	Time	Status	Verify Mode
		09-05 17:21	Failed	Face
1	zxl	09-05 17:19	OK	Face
1	zxl	09-05 17:19	OK	Face
1	zxl	09-05 17:19	OK	Face
1	zxl	09-05 17:19	OK	Face
		09-05 17:18	Failed	Face
		09-05 17:18	Failed	Face
		09-05 17:18	Failed	Face
		09-05 17:18	Failed	Face
		09-05 17:18	Failed	Face
		09-05 17:18	Failed	Face
		09-05 17:18	Failed	Face

### 3.15 System Info

You can view data capacity, device version, and firmware information of the access controller on the **System Info** interface.

Step 1 Log in to the **Main Menu** interface.

Step 2 Tap **System Info**, and the **System Info** interface is displayed.

Figure 3-30 System info



# 4 Web Operations

The access controller can be configured and operated on the web. Through the web you can set network parameters, video parameters, and access controller parameters; and you can also maintain and update the system.

## 4.1 Initialization

You need to set a password and an email address before logging in to the web for the first time.

**Step 1** Open IE web browser, and enter the IP address (the default address is 192.168.1.108) of the access controller in the address bar, and then press Enter.



- Use browser newer than IE 8, otherwise you might not log in to the web.
- Make sure that the computer used to log in to the web is in the same LAN with the device.

Figure 4-1 Initialization

**Step 2** Enter the new password, confirm password, enter an email address, and then click **Next**.



- The password must consist of 8 to 32 non-blank characters and contain at least two types of characters among upper case, lower case, number, and special character (excluding ' " ; : & ). Set a password of high security level according to the password strength prompt.
- For security, keep the password properly after initialization and change the password regularly.
- When you need to reset the administrator password by scanning the QR code, you need an email address to receive the security code.



Step 3 Click **Next**.

Figure 4-2 Auto check

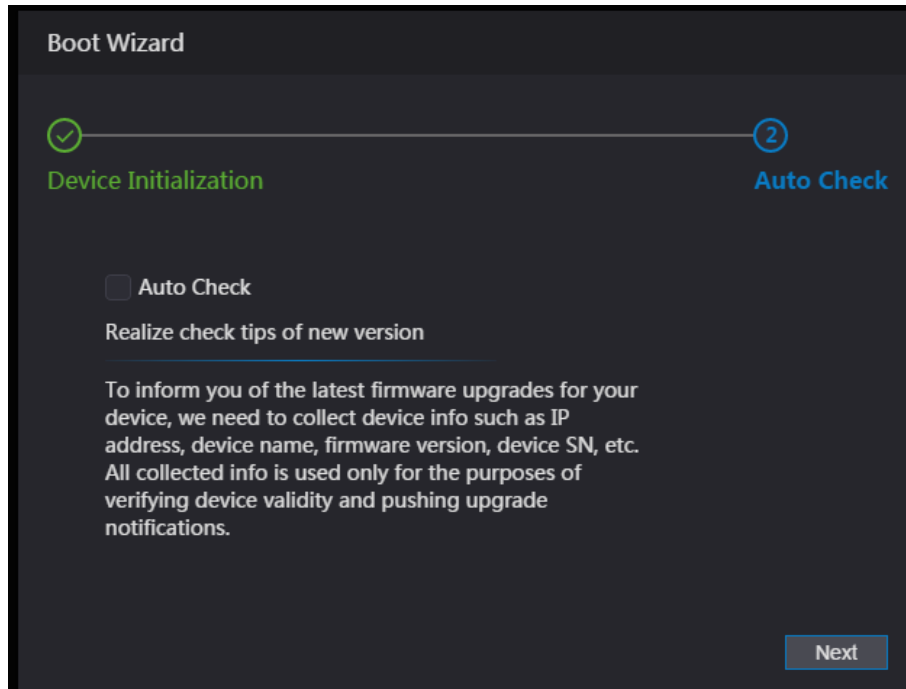

Step 4 You can decide whether to select **Auto Check** or not.



It is recommended that **Auto Check** be selected to get the latest program in time.

Step 5 Click **Next**.

Figure 4-3 Finished configuration

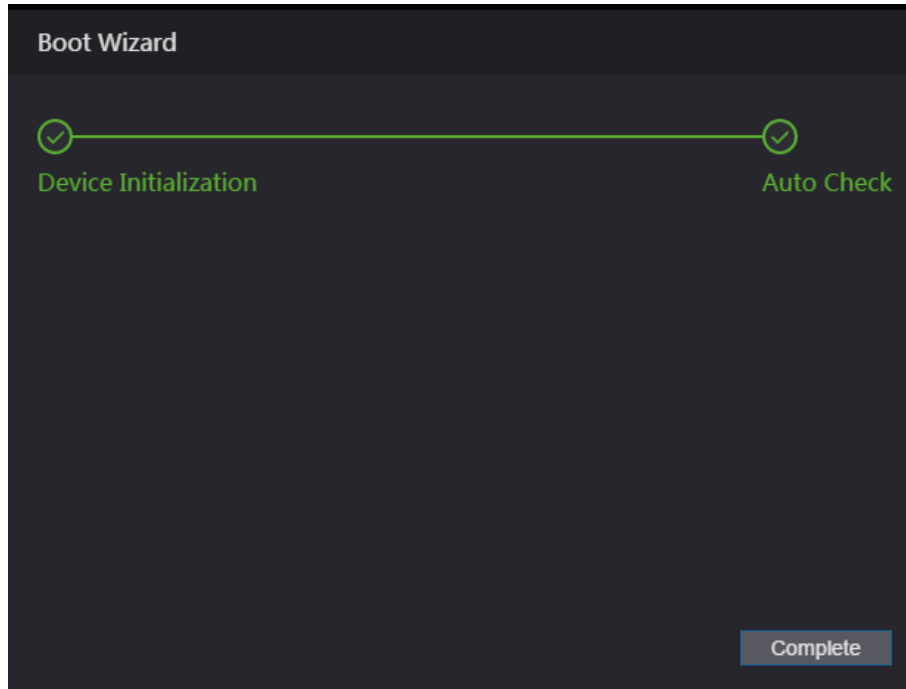

Step 6 Click **Complete**, and the initialization is completed.  
The web login interface is displayed.

## 4.2 Login

Step 1 Open IE web browser, enter the IP address of the access controller in the address bar, and press **Enter**.



- Use browser newer than IE 8, otherwise you might not log in to the web.
- Make sure that the computer used to log in to the web is in the same LAN with the device.
- The default IP address is 192.168.1.108.

Figure 4-4 Login

**WEB SERVICE**

Username:

Password:

[Forgot Password?](#)

**Login**

Step 2 Enter the user name and password.



- The default administrator name is admin, and the password is the login password after initializing the access controller. Modify the administrator regularly and keep it properly for the sake of security.
- If you forget the administrator login password, you can click **Forgot password?** to reset it. See "4.3 Resetting the Password."

Step 3 Click **Login**.

The web interface is logged in.

## 4.3 Resetting the Password

When resetting the password of the admin account, your email address will be needed.

Step 1 Click **Forgot password?** on the login interface.

The **Tips** interface is displayed.

Figure 4-5 Tips

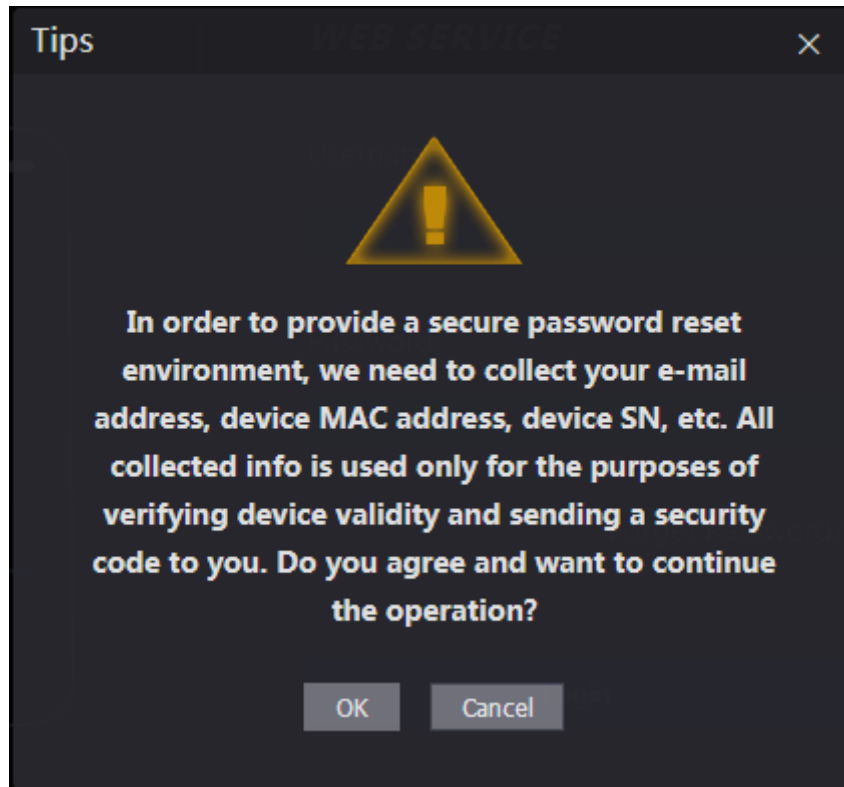

Step 2 Read the tips.

Step 3 Click **OK**.

The **Reset Password** interface is displayed.

Figure 4-6 Reset Password

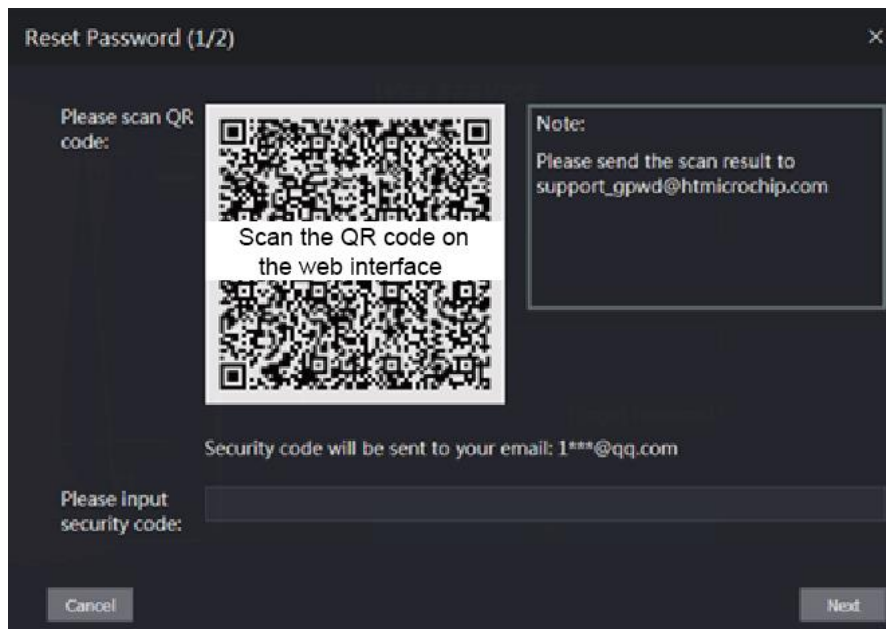

Step 4 Scan the QR code on the interface, and you will get the security code.



- At most two security codes will be generated by scanning the same QR code. If security codes become invalid, to get more security codes, refresh the QR code.
- You need to send the content you get after you scanned the QR code to the designated email address, and then you will get the security code.

- Please use the security code within 24 hours after you receive it. Otherwise, it will become invalid.
- If wrong security codes are entered for consecutive five times, the administrator will be frozen for five minutes.

Step 5 Enter the security code you have received.

Step 6 Click **Next**.

The **Reset Password** interface is displayed.

Step 7 Reset and confirm the new password.



The password should consist of 8 to 32 non-blank characters and contain at least two types of characters among upper case, lower case, number, and special character (excluding ' " ; : &).

Step 8 Click **OK**, and the reset is completed.

## 4.4 Alarm Linkage

### 4.4.1 Setting Alarm Linkage

Alarm input devices can be connected to the access controller, and you can modify the alarm linkage parameter as needed.

Step 1 Log in to the web interface.

Step 2 Select **Alarm Linkage** on the navigation bar.

The **Alarm Linkage** interface is displayed.

Figure 4-7 Alarm linkage

Alarm Input	Name	Alarm Input Type	Alarm Output Channel	Modify
1	Zone1	NO	1	



Step 3 Click , and then you can modify alarm linkage parameters.

Figure 4-8 Modifying alarm linkage parameter

Table 4-1 Alarm linkage parameter description

Parameter	Description
Alarm Input	You cannot modify the value. Keep it default.
Name	Enter a zone name.
Alarm Input Type	There are two options: NO and NC. If alarm input type of the alarm device you purchased is NO, then you should select NO; otherwise you should select NC.
Fire Link Enable	If fire link is enabled the access controller will output alarms when fire alarms are triggered. The alarm details will be displayed in the alarm log.  Alarm output and access link are NO by default if fire link is enabled.
Access Link Enable	After the Access Link is enabled, the access controller will be normally on or normally closed when there are input alarm signals.
Channel Type	There are two options: NO and NC.

**Step 4** Click **OK**, and then the configuration is completed.



The configuration on the web will be synchronized with the configuration in the client if the access controller is added to a client.

## 4.4.2 Alarm Log

You can view the alarm type and time range in the **Alarm Log** interface.

**Step 1** Log in to the web interface.

**Step 2** Select **Alarm Linkage > Alarm Log**.

The **Alarm Log** interface is displayed.

Figure 4-9 Alarm log

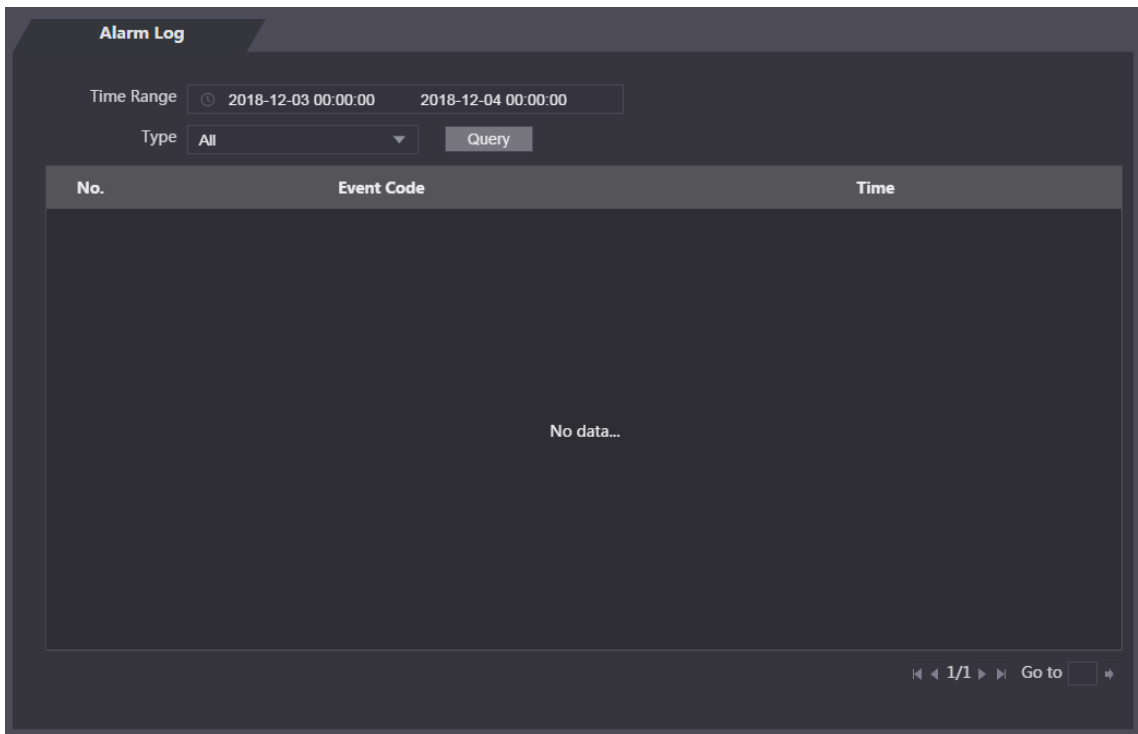

**Step 3** Select a time range and alarm type, and then click **Query**.  
The query results are displayed.

Figure 4-10 Query results

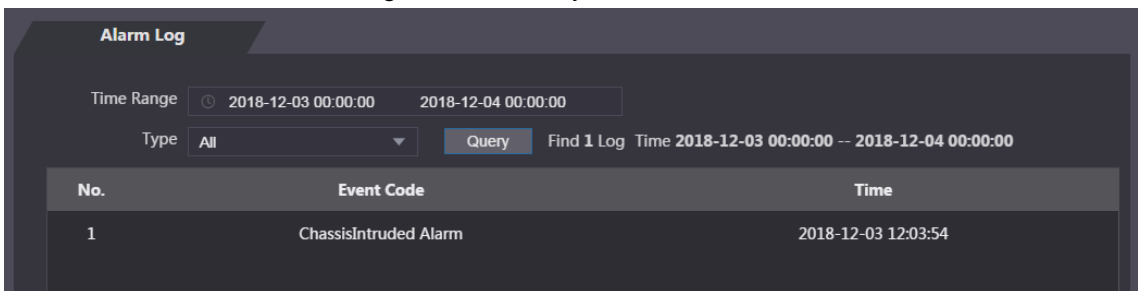

## 4.5 Data Capacity

You can see how many users, cards, fingerprints and face images the access controller can hold on the **Data Capacity** interface.

**Step 1** Log in to the web interface.

**Step 2** Select **Data Capacity** on the navigation bar.

The **Data Capacity** interface is displayed.

## 4.6 Video Setting

You can set parameters including data rate, image parameters (brightness, contrast, hue, saturation, and more), and exposure on the **Video Setting** interface.

## 4.6.1 Data Rate

You can configure stream parameters for channel 1.

Step 1 Log in to the web interface.

Step 2 Select **Video Setting > Video Setting > Data Rate**.

Figure 4-11 Data rate

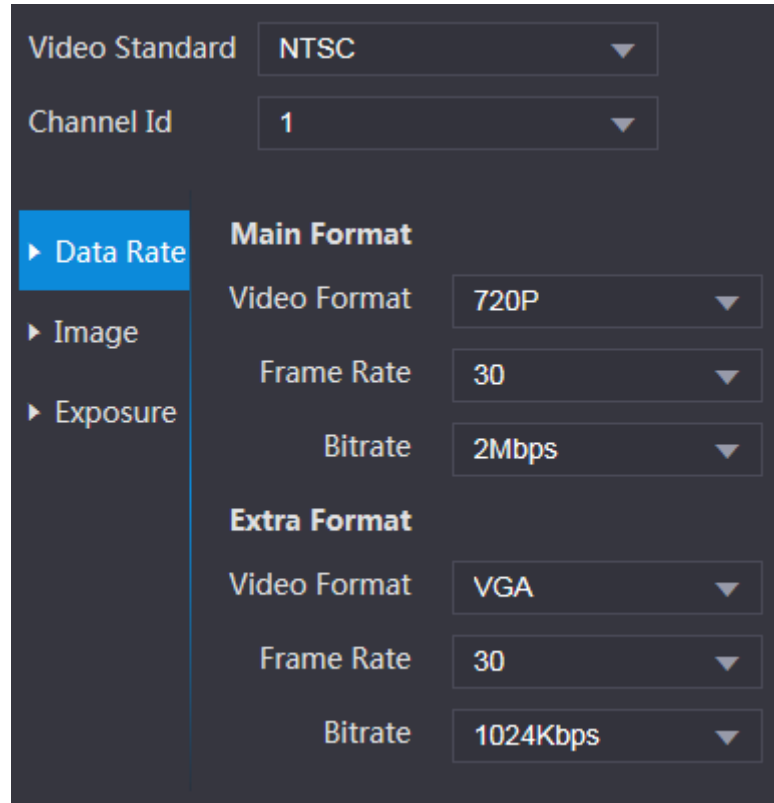

Table 4-2 stream parameter description

Parameter	Description	
Video Standard	There are two options: NTSC and PAL. Select a standard according to the video standard of your region.	
Channel	There are two options: 1 and 2. 1 is white light camera and 2 is IR light camera.	
Main Format	Video Format	There are four options: D1, VGA, 720p and 1080p. Select an option according to the video quality you want.
	Frame Rate	The rate at which consecutive frames appear on a display. The frame rate range is 1–30fps.
	Bit Rate	The number of bits that are conveyed or processed per unit of time. There are five options: 2Mbps, 4Mbps, 6Mbps, 8Mbps, and 10Mbps.
Extra Format	Video Format	There are three options: D1, VGA, and QVGA.
	Frame Rate	The rate at which consecutive frames appear on a display. The frame rate range is 1–30fps.

	Bit Rate	The number of bits that are conveyed or processed per unit of time. There are options: 512Kbps, 640Kbps, 768Kbps, 896Kbps, 1024Kbps, 1.25Mbps, 1.5Mbps, 1.75Mbps, and 2Mbps.
--	----------	--

## 4.6.2 Image

There are two channels, and you need to configure parameters for each channel.

Step 1 Log in to the web interface.

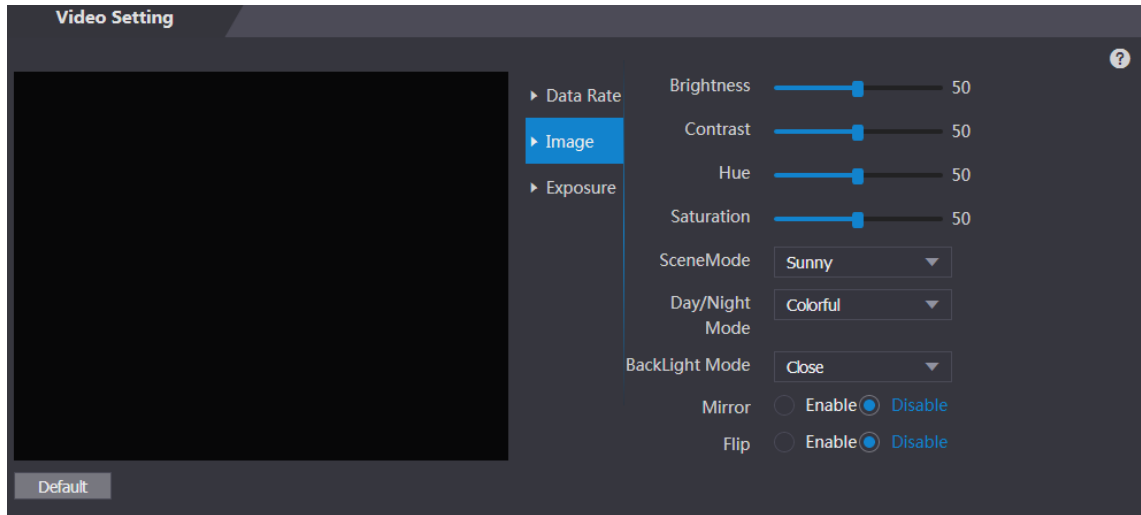

Step 2 Select **Video Setting > Video Setting > Image**.

Figure 4-12 Image



Step 3 Select **Wide Dynamic** in the Backlight Mode.

Table 4-3 Image parameter description

Parameter	Description
Brightness	The larger the value is, the brighter the images will be.
Contrast	Contrast is the difference in luminance or color that makes an object distinguishable. The larger the contrast value is, the greater the brightness and color contrast will be.
Hue	The larger the value is, the deeper the color will be.
Saturation	The larger the value is, the brighter the colors will be.  The value does not change image brightness.
Scene Mode	<ul style="list-style-type: none"> <li>Close: Without modes.</li> <li>Auto: The system automatically adjusts scene modes.</li> <li>Sunny: In this mode, image hue will be reduced.</li> <li>Night: In this mode, image hue will be increased.</li> </ul>  <b>Sunny</b> is selected by default.
Day/Night Mode	Day/Night mode decides the working status of the fill light. <ul style="list-style-type: none"> <li>Auto: The system automatically adjusts the day/night modes.</li> <li>Colorful: In this mode, images are with colors.</li> <li>Black and white: In this mode, images are in black and white.</li> </ul>



Backlight Mode	<ul style="list-style-type: none"> <li>● Close: Without backlight compensation.</li> <li>● BLC: Backlight compensation corrects regions with extremely high or low levels of light to maintain a normal and usable level of light for the object in focus.</li> <li>● WDR: In the wide dynamic range mode, the system dims bright areas and compensates dark areas to ensure the definition of objects in the bright areas and dark areas.</li> </ul>  <p>When human faces are in the backlight, you need to enable WDR.</p> <ul style="list-style-type: none"> <li>● HLC: Highlight compensation is needed to compensate for overexposure of highlights or strong light sources like spotlights, headlights, porch lights, etc. to create an image that is usable and not overtaken by a bright light.</li> </ul>
Mirror	When the function is enabled, images will be displayed with left and right side reversed.
Flip	When this function is enabled, images can be flipped over.

### 4.6.3 Exposure

You can configure exposure parameters.

Step 1 Log in to the web interface.

Step 2 Select **Video Setting > Video Setting > Exposure**.

Figure 4-13 Exposure

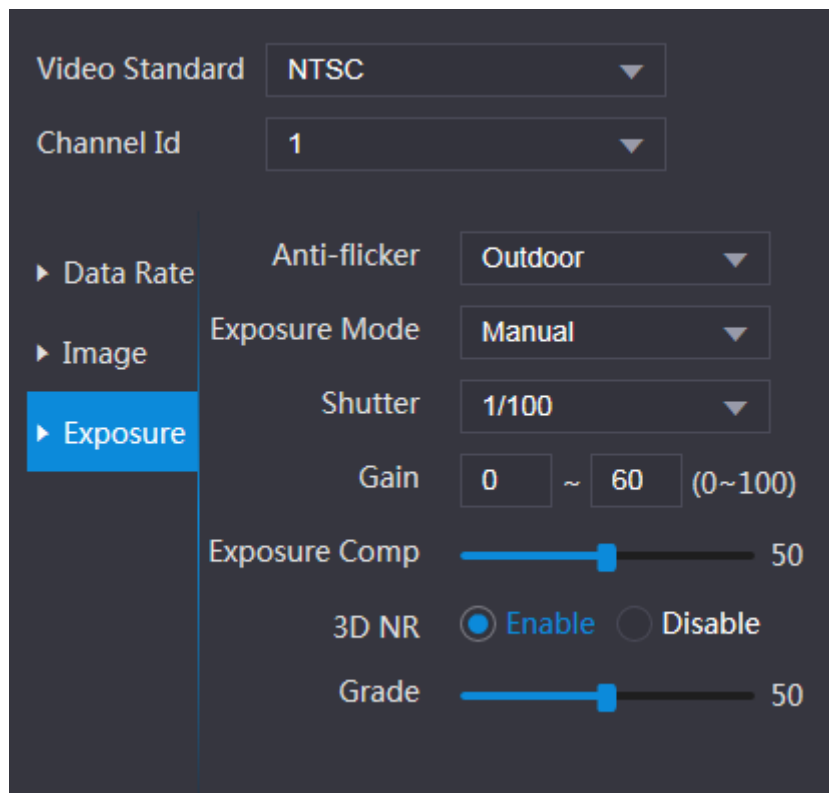



Table 4-4 Exposure parameter description

Parameter	Description
Anti-flicker	<ul style="list-style-type: none"> <li>50Hz: When the utility frequency of alternating current is 50Hz, the exposure is automatically adjusted to make sure that there are no stripes on images.</li> <li>60Hz: When the utility frequency of alternating current is 60Hz, the exposure is automatically adjusted to make sure that there are no stripes on images.</li> <li>Outdoor: When <b>Outdoor</b> is selected, the exposure mode can be switched.</li> </ul>
Exposure Mode	 <ul style="list-style-type: none"> <li>When you select <b>Outdoor</b> in the Anti-flicker drop-down list, you can select <b>Shutter Priority</b> as the exposure mode.</li> <li>Exposure modes of different devices might vary, and the actual product shall prevail.</li> </ul> <p>You can select from:</p> <ul style="list-style-type: none"> <li>Auto: The access controller will automatically adjust brightness of images.</li> <li>Shutter Priority: The access controller will adjust image brightness according to shutter exposure value range. If the image brightness is not enough and the shutter value has reached upper or lower limit, the access controller will adjust gain value automatically to get ideal brightness.</li> <li>Manual: You can configure gain and shutter value manually to adjust image brightness.</li> </ul>
Shutter	The larger the shutter value is and the shorter the exposure time is, the darker the images will be.
Shutter Value Range	If you select <b>Customized Range</b> , you can customize the shutter value range.
Gain Value Range	When the gain value range is set, video quality will be improved.
Exposure Compensation	You can increase video brightness by adjusting exposure compensation value.
3D NR	When 3D Noise Reduction (RD) is enabled, video noise can be reduced, and high definition videos will be produced.
Grade	You can adjust the value of the 3D NR when 3D NR is enabled. The larger the value is, the less the noise there will be.

## 4.6.4 Motion Detection

Set a range in which moving objects can be detected.

Step 1 Log in to the web interface.

Step 2 Select **Video Setting > Motion Detection**.

The **Motion Detection** interface is displayed.

Figure 4-14 Motion detection

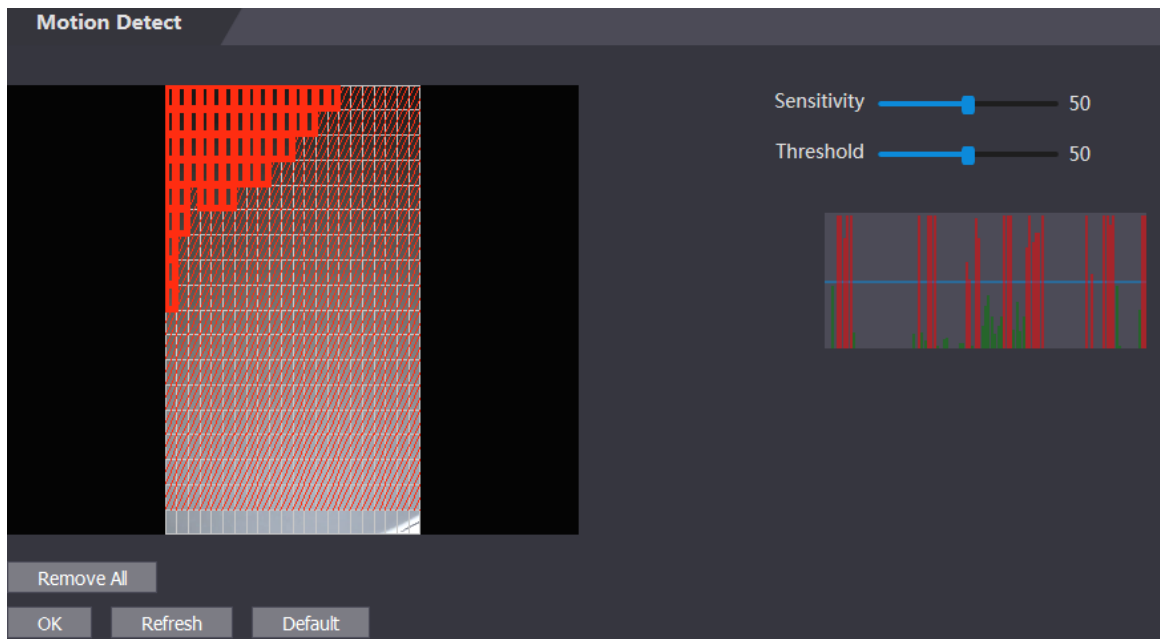

Step 3 Press and hold the left mouse button, and then drag the mouse in the red area. The **Motion Detection** area is displayed.



- The red rectangles are motion detection area. The default motion detection range is all the rectangles.
- To draw a motion detection area, you need to click **Remove All** first.
- The motion detection area you draw will be a non-motion detection area if you draw in the default motion detection area.

Figure 4-15 Motion detection area

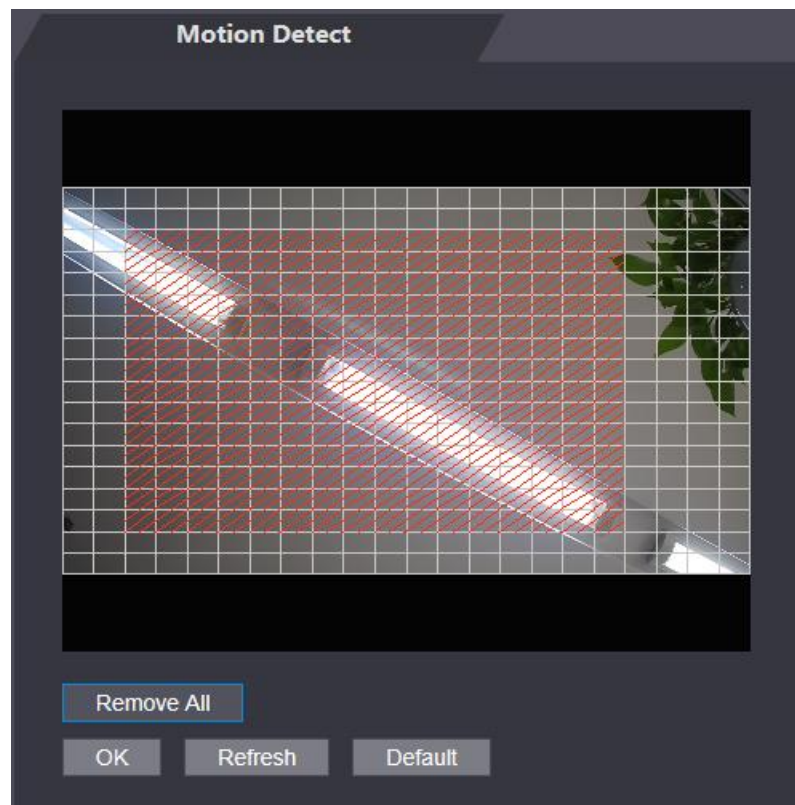

Step 4 Set sensitivity and threshold.



- Sensitivity represents the ability of each grid to sense motion. The larger the value is, the higher the sensitivity is.
- Threshold is the condition of motion detection. When grid number reaches the threshold, motion detection will be triggered. The smaller the value is, the more likely the motion detection will be triggered.
- When grid number is smaller than the threshold, green line will appear; when grid number is more than the threshold, red line will appear. See Figure 4-14.

Step 5 Click **OK** to finish the setting.

## 4.6.5 Volume Setting

You can adjust volume of the access controller speaker.

Step 1 Log in to the web interface.

Step 2 Select **Video Setting > Volume Setting**.

Figure 4-16 Volume setting

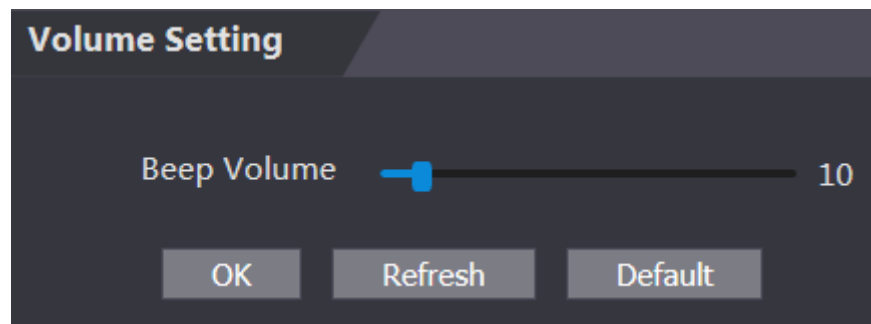

## 4.6.6 Image Mode

There are three options: indoor, outdoor and other. Select **Indoor** when the access controller is installed indoors; select **Outdoor** when the access controller is installed outdoors; and select **Other** when the access controller is installed at places with backlights like corridors and hallways.

Step 1 Log in to the web interface.

Step 2 Select **Video Setting > Image Mode**.

Figure 4-17 Image mode

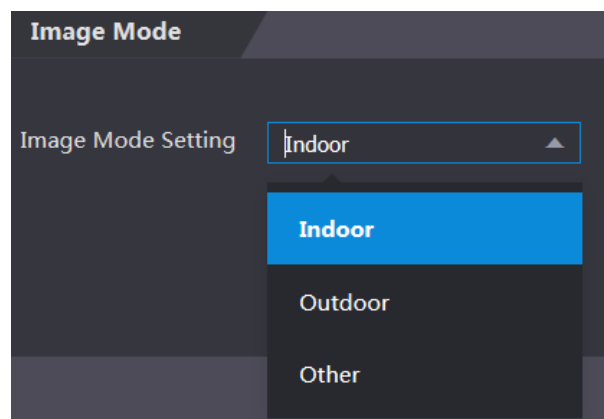

## 4.7 Face Detect

You can configure human face related parameters on this interface to increase the accuracy of the face recognition.

**Step 1** Log in to the web interface.

**Step 2** Select **Face Detect**.

Figure 4-18 Face detect

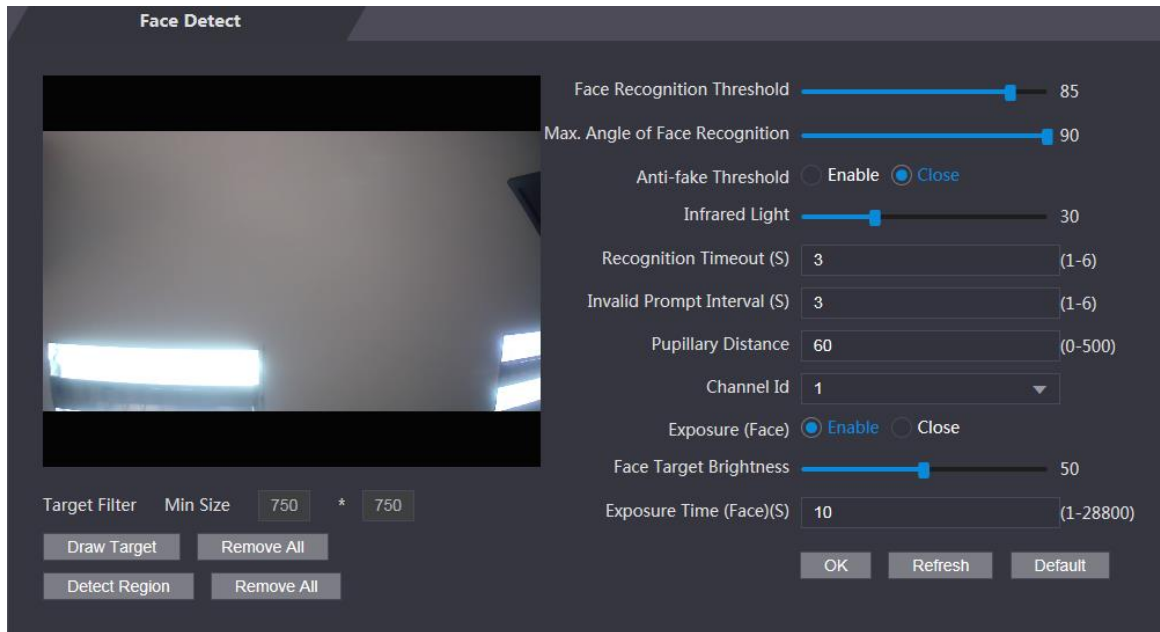

**Step 3** Configure parameters.

Table 4-5 Face detect parameter description

Parameter	Description
Face Recognition Threshold	The larger the value is, the higher the accuracy will be.
Max. Angle of Face Recognition	The larger the angle is, the wider range of the profiles will be recognized.
Anti-fake Threshold	This function prevents people from unlocking by human face images or face models. There are two options: <b>Enable</b> and <b>Close</b> .
Infrared Light	Adjust IR brightnees by dragging the scroll bar.
Recognition Timeout	The interval of the prompt during valid face recognition.
Prompt Interval	The interval of the prompt during invalid face recognition.
Pupillary Distance	Pupillary distance is the pixel value of the image between the centers of the pupils in each eye. You need to set an appropriate value so that the access controller can recognize faces as needed. The value changes according to the face sizes and the distance between faces and the lens. The closer the face is to the lens, the greater the value should be. If an adult is 1.5 meters away from the lens, the pupillary distance value can be within 50 to 70.
Channel Id	There are two options: 1 and 2. 1 is white light camera and 2 is IR light camera.

Exposure(Face)	After face exposure is enabled, human face will be clearer when the access controller is installed outdoors.
Face Target Brightness	The default value is 50. Adjust the brightness as needed.
Exposure Time(Face)	After a face is detected, the access controller will give out light to illuminate the face, and the access controller will not give out light again until the interval you set has passed.
Draw Target	Click <b>Draw Target</b> , and then you can draw the minimum face detection frame. Click <b>Remove All</b> , and you can remove all the frames you drew.
Detect Region	Click <b>Detect Region</b> , move your mouse, and you can adjust the face detection region. Click <b>Remove All</b> , and you can remove all the detection regions.

Step 4 Click **OK** to finish the setting.

## 4.8 Network Setting

### 4.8.1 TCP/IP

You need to configure IP address and DNS server to make sure that the access controller can communicate with other devices.

Make sure that the access controller is connected to the network correctly.

Step 1 Log in to the web interface.

Step 2 Select **Network Setting > TCP/IP**.

Figure 4-19 TCP/IP

Step 3 Configure parameters.

Table 4-6 TCP/IP

Parameter	Description
IP Version	There is one option: IPv4.
MAC Address	MAC address of the access controller is displayed.
Mode	<ul style="list-style-type: none"> <li>• Static Set IP address, subnet mask, and gateway address manually.</li> <li>• DHCP <ul style="list-style-type: none"> <li>◇ After DHCP is enabled, IP address, subnet mask, and gateway address cannot be configured.</li> <li>◇ If DHCP is effective, IP address, subnet mask, and gateway address will be displayed automatically; if DHCP is not effective, IP address, subnet mask, and gateway address will all be zero.</li> <li>◇ If you want to see the default IP when DHCP is effective, you need to disable DHCP.</li> </ul> </li> </ul>
Link-local address	Link-local address is only available when IPv6 is selected in the IP version. Unique link-local addresses will be assigned to network interface controller in each local area network to enable communications. The link-local address cannot be modified.
IP Address	Enter IP address, and then configure subnet mask and gateway address.
Subnet Mask	
Default Gateway	IP address and gateway address must be in the same network segment.
Preferred DNS Server	Set IP address of the preferred DNS server.
Alternate DNS Server	Set IP address of the alternate DNS server.

**Step 4** Click **OK** to complete the setting.

## 4.8.2 Port

Set the maximum connections clients that the access controller can be connected to and port numbers.

**Step 1** Log in to the web interface.

**Step 2** Select **Network Setting > Port**.

The **Port** interface is displayed.

**Step 3** Configure port numbers. See the following table.



Except max connection, you need to reboot the access controller to make the configuration effective after modifying values.

Table 4-7 Port description

Parameter	Description
Max Connection	<p>You can set the maximum connections of clients that the access controller can be connected to.</p> <p></p> <p>Platform clients like SmartPSS AC are not counted.</p>

TCP Port	Default value is 37777.
HTTP Port	Default value is 80. If other value is used as port number, you need to add this value behind the address when logging in through browsers.
HTTPS Port	Default value is 443.
RTSP Port	Default value is 554.

Step 4 Click **OK** to complete the setting.

### 4.8.3 Register

When connected to external network, the access controller will report its address to the server that is designated by the user so that clients can get access to the access controller.

Step 1 Log in to the web interface.

Step 2 Select **Network Setting > Auto Register**.

The **Auto Register** interface is displayed.

Step 3 Select **Enable**, and enter host IP, port, and sub device ID.

Table 4-8 Auto register description

Parameter	Description
Host IP	Server IP address or server domain name.
Port	Server port used for auto registration.
Sub Device ID	Access controller ID assigned by the server.

Step 4 Click **OK** to complete the setting.

### 4.8.4 P2P

Peer-to-peer computing or networking is a distributed application architecture that partitions tasks or workloads between peers. Users can download mobile application by scanning QR code, and then register an account so that more than one access controller can be managed on the mobile app. You do not need to apply dynamic domain name, do port mapping or do not need transit server.



If you are to use P2P, you must connect the access controller to external network; otherwise the access controller cannot be used.



Figure 4-20 P2P

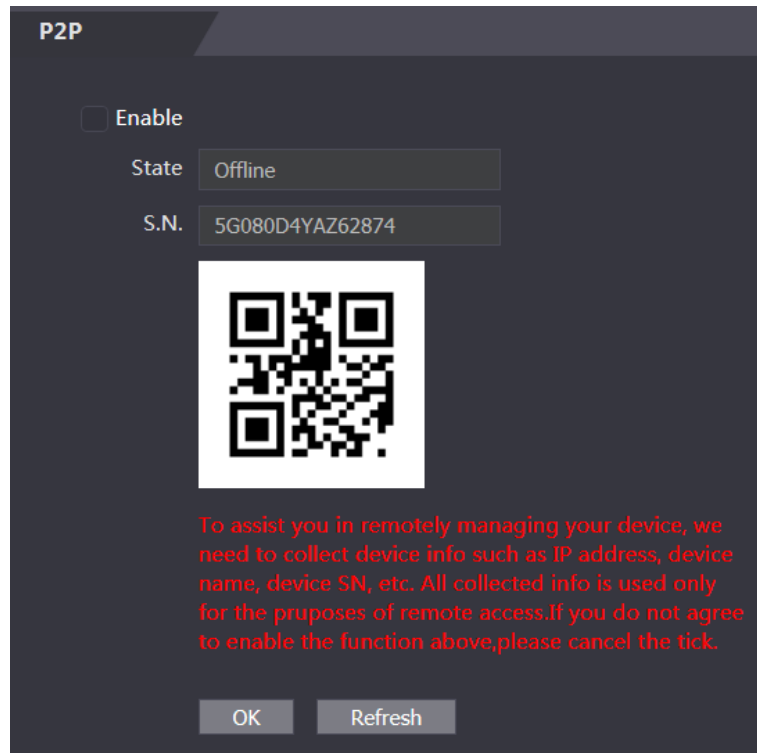

Step 1 Log in to the web interface.

Step 2 Select **Network Setting > P2P**.

The **P2P** interface is displayed.

Step 3 Select **Enable** to enable P2P function.

Step 4 Click **OK** to complete the setting.



Scan the QR code on your web interface to get the serial number of the access controller.

## 4.9 Safety Management

### 4.9.1 IP Authority

Select a cyber security mode as needed.

Figure 4-21 IP authority

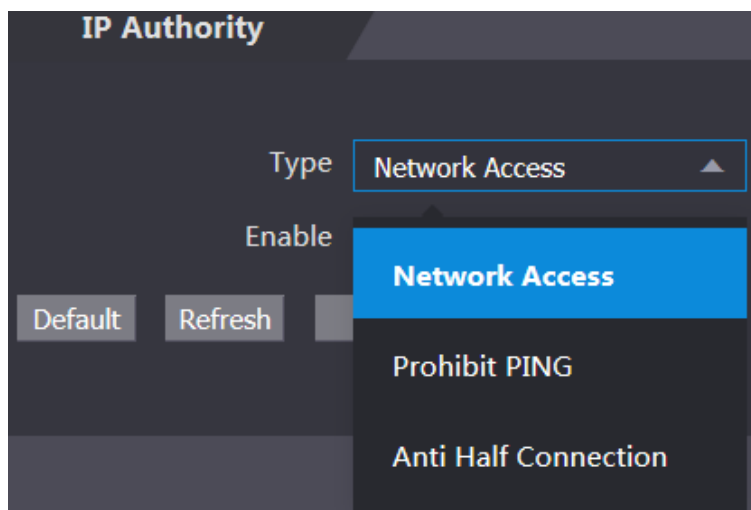

## 4.9.2 Systems

### 4.9.2.1 System Service

There are four options: SSH, PWD Reset Enable, CGI, and HTTPS. Refer to "3.13 Features" to select one or more than one of them.



The system service configuration done on the web page and the configuration on the **Features** interface of the access controller will be synchronized.

Figure 4-22 System service

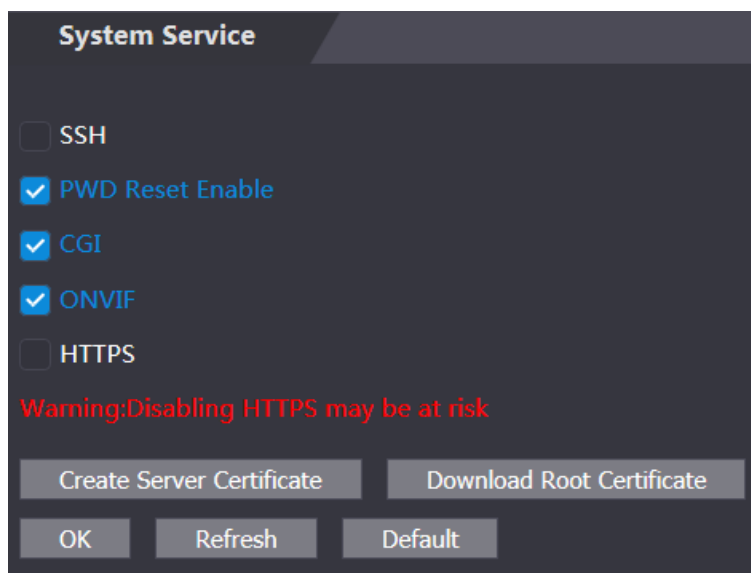

### 4.9.2.2 Creating Server Certificate

Click **Create Server Certificate**, enter needed information, click **Save**, and then the access controller will reboot.

### 4.9.2.3 Downloading Root Certificate

Step 1 Click Download Root Certificate.

Select a path to save the certificate on the **Save File** dialog box.

Step 2 Double-click on the **Root Certificate** that you have downloaded to install the certificate.

Install the certificate by following the onscreen instructions.

## 4.10 User Management

You can add and delete users, modify users' passwords, and enter an email address for resetting the password when you forget your password.

### 4.10.1 Adding Users

Click **Add** on the **User Mgmt.** interface to add users, and then enter username, password, confirmed password, and remark. Click **OK** to complete the user adding.

### 4.10.2 Modifying User Information

You can modify user information by clicking  on the **User Mgmt.** interface.

Figure 4-23 User management

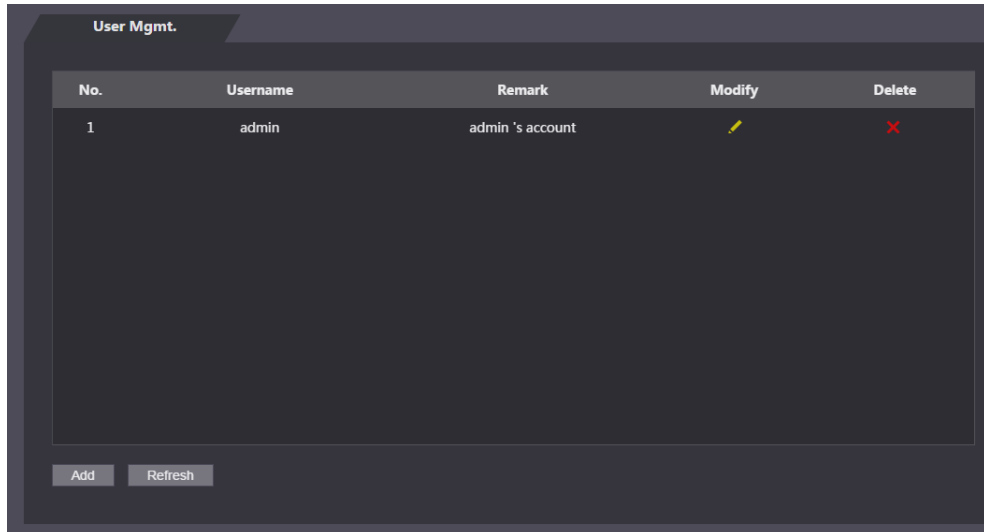

### 4.10.3 ONVIF User

Open Network Video Interface Forum (ONVIF), a global and open industry forum with the goal of facilitating the development and use of a global open standard for the interface of physical IP-based security products. When ONVIF is used, administrator, operator, and user have different permission of ONVIF server. Create ONVIF users as needed.

Figure 4-24 Onvif user

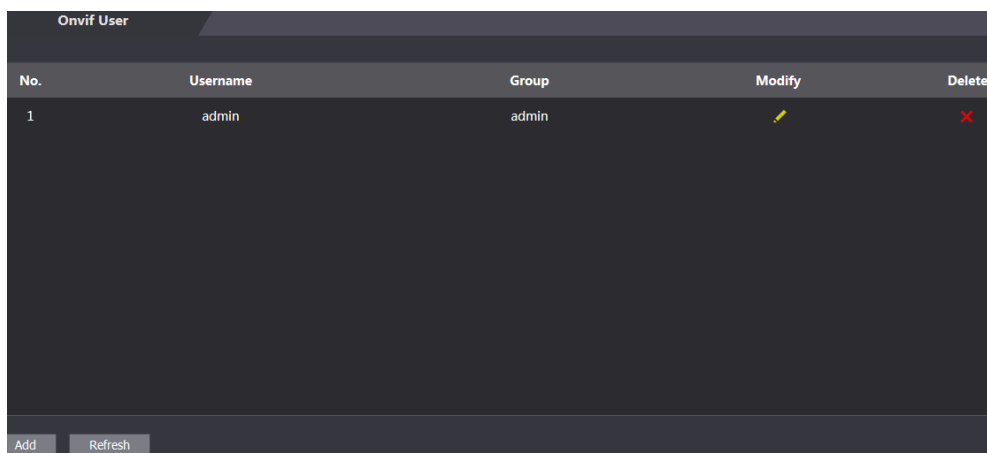

No.	Username	Group	Modify	Delete
1	admin	admin		

At the bottom of the interface, there are two buttons: "Add" and "Refresh".

## 4.11 Maintenance

You can make the access controller reboot itself in idle time to improve the running speed of the access controller. You need to set the auto reboot date and time.

Step 1 Log in to the web interface.

Step 2 Select **Maintenance** on the navigation bar.

Step 3 Set the auto reboot time, and then click **OK**.

Figure 4-25 Maintenance

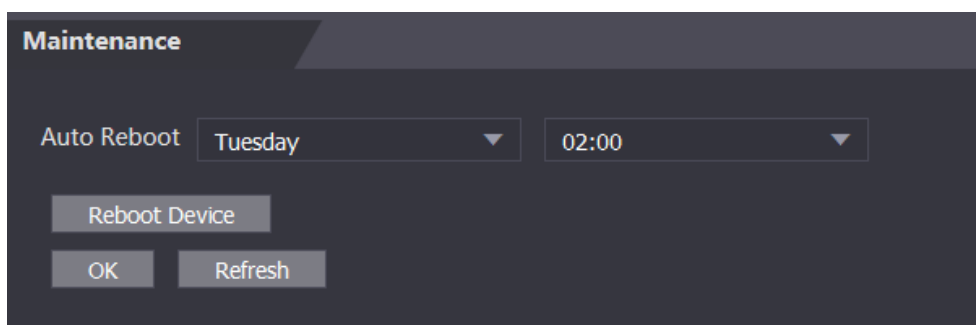

The screenshot shows the "Maintenance" configuration page. It features two dropdown menus for "Auto Reboot" (set to "Tuesday") and "02:00". Below these are three buttons: "Reboot Device", "OK", and "Refresh".

For example, the access controller will reboot at 2 O'clock in the morning every Tuesday.

Click **Reboot Device**, the access controller will reboot immediately.

## 4.12 Configuration Management

When more than one access controller needs the same configuration, you can configure parameters for them by importing or exporting configuration files.

### 4.12.1 Exporting Configuration File

You can export the configuration file of the access controller for backup.

Step 1 Log in to the web interface.

Step 2 Select **Config Mgmt.** on the navigation bar.

Figure 4-26 Configuration management

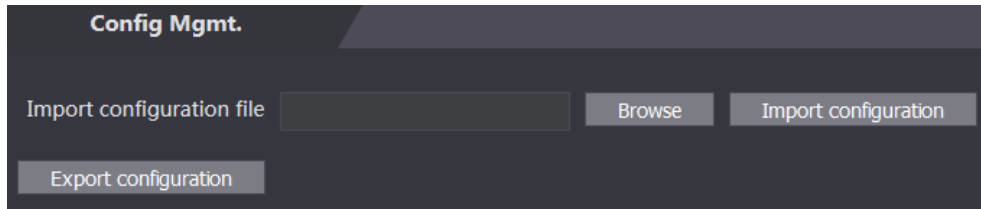

Step 3 Click **Export configuration** to save the configuration file locally.



IP information of the access controller will not be exported.

## 4.12.2 Importing Configuration File

You can import the configuration file that is exported from an access controller to another access controller with the same model.

Step 1 Log in to the web interface.

Step 2 Select **Config Mgmt.** on the navigation bar.

Step 3 On the configuration management interface, click **Browse** to select the configuration file that you want to import, and then click **Import configuration**.

The access controller will reboot after importing configuration file.

## 4.13 Upgrade



- Export the configuration file for backup before upgrade, and then import it after the upgrade is completed.
- Make sure that the upgrade file has been obtained. You can get it from technical support.
- Do not disconnect the power or network, or reboot or shutdown the Device during upgrade.

Step 1 Log in to the web interface.

Step 2 Select **Upgrade** on the navigation bar.

Step 3 On the **Upgrade** interface, click **Browse** to select the upgrade file, and then click **Upgrade**.

Figure 4-27 Upgrade

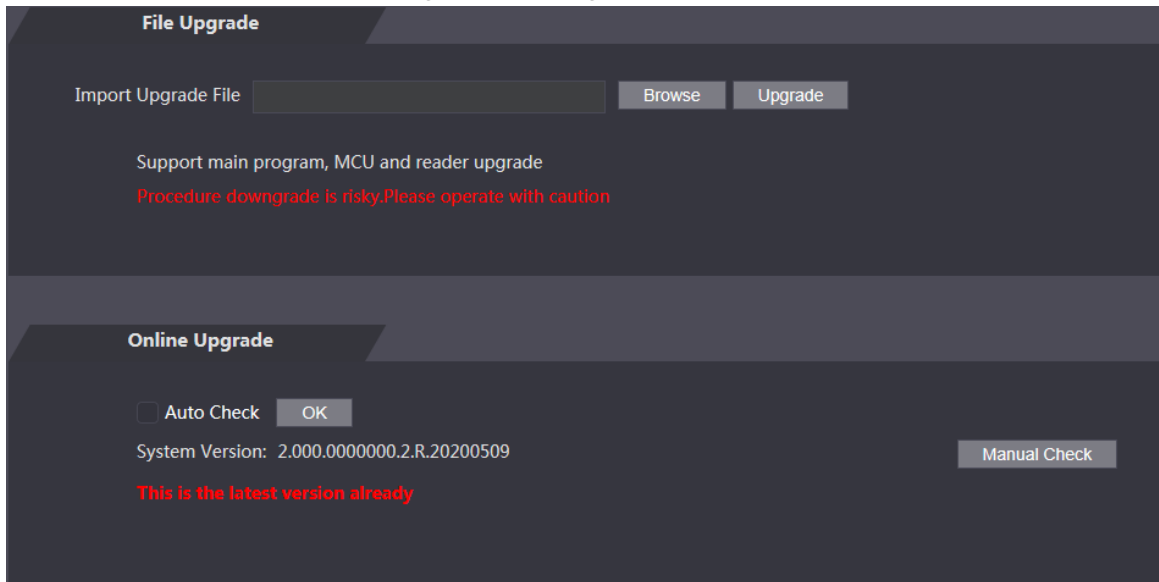

If the upgrade is succeeded, the system pops up a message indicating that the upgrade is completed. If the upgrade is failed, there will be corresponding prompts.



- You can select **Auto Check** to upgrade the system automatically. You can also select **Manual Check** to upgrade the system manually.
- The access controller will reboot after upgrade.
- You click **Version Info** on the left navigation menu to check version after upgrade.

## 4.14 Version Information

You can view information including MAC address, serial number, MCU version, web version, security baseline version, system version, and firmware version.

Step 1 Log in to the web interface.

Step 2 Select **Version Info** on the navigation bar.

The Version Info interface is displayed.

## 4.15 Online User

You can view username, IP address, and user login time on the **Online User** interface.

Step 1 Log in to the web interface.

Step 2 Select **Online User** on the navigation bar.

Figure 4-28 Online user

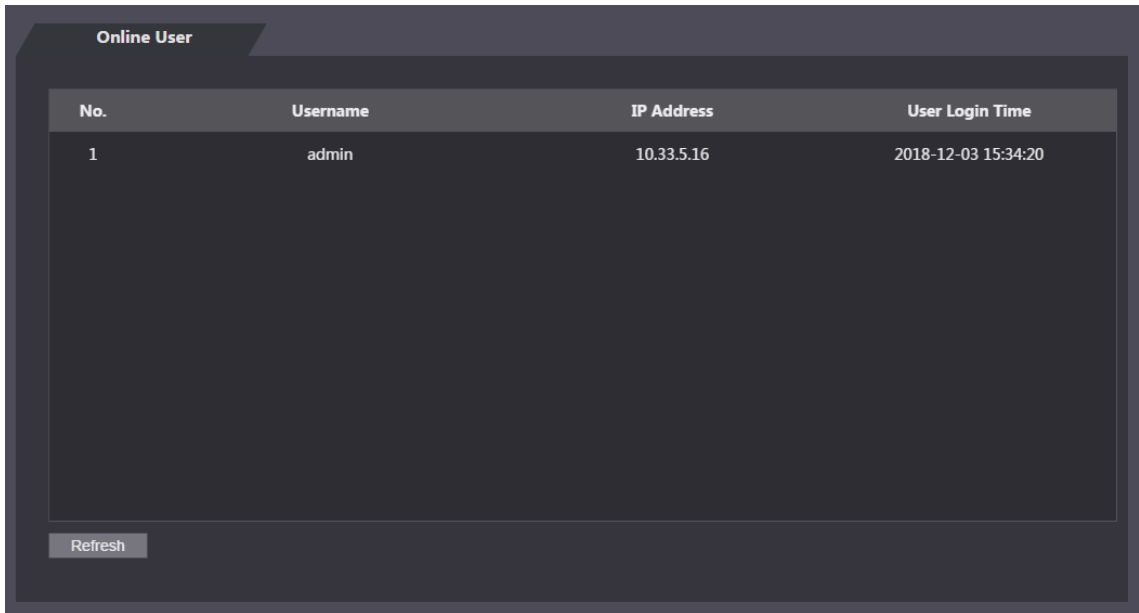

The screenshot shows a web interface titled "Online User". It contains a table with the following columns: "No.", "Username", "IP Address", and "User Login Time". There is one row of data. Below the table is a "Refresh" button.

No.	Username	IP Address	User Login Time
1	admin	10.33.5.16	2018-12-03 15:34:20

## 4.16 System Log

You can query and backup system logs on the **System Log** interface.

### 4.16.1 Querying Logs

You can query system logs.

**Step 1** Log in to the web interface.

**Step 2** Select **System Log** on the navigation bar.

**Step 3** Select a time range and its type, and then click **Query**.

Logs meet the conditions will be displayed.

Figure 4-29 Querying logs

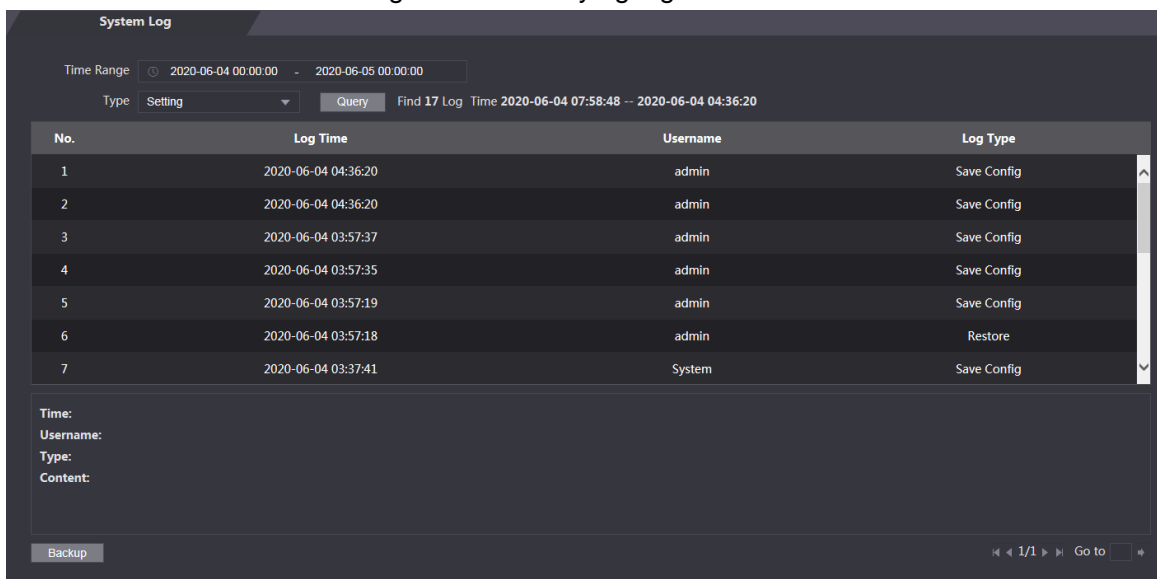

The screenshot shows the "System Log" interface. At the top, there is a "Time Range" selector set to "2020-06-04 00:00:00 - 2020-06-05 00:00:00". Below it is a "Type" dropdown menu set to "Setting" and a "Query" button. The main area displays a table of logs. Below the table, there are fields for "Time:", "Username:", "Type:", and "Content:". At the bottom left is a "Backup" button, and at the bottom right are navigation controls including "Go to" and a page indicator "1/1".

No.	Log Time	Username	Log Type
1	2020-06-04 04:36:20	admin	Save Config
2	2020-06-04 04:36:20	admin	Save Config
3	2020-06-04 03:57:37	admin	Save Config
4	2020-06-04 03:57:35	admin	Save Config
5	2020-06-04 03:57:19	admin	Save Config
6	2020-06-04 03:57:18	admin	Restore
7	2020-06-04 03:37:41	System	Save Config

## 4.16.2 Backup Logs

You can back up the queried logs.

Step 1 Log in to the web interface.

Step 2 Select **System Log** on the navigation bar.

Step 3 Select a time range and its type, and then click **Query**.

Step 4 Click **Backup** to back up the logs displayed.

## 4.16.3 Admin Log

You can search Admin logs by Admin ID.

Step 1 Log in to the web interface.

Step 2 Select **System Log > Admin Log**.

Step 3 On the **Admin Log** interface, enter Admin ID, and then click **Query**.

You will see the administrator's operation records.

Figure 4-30 Admin log

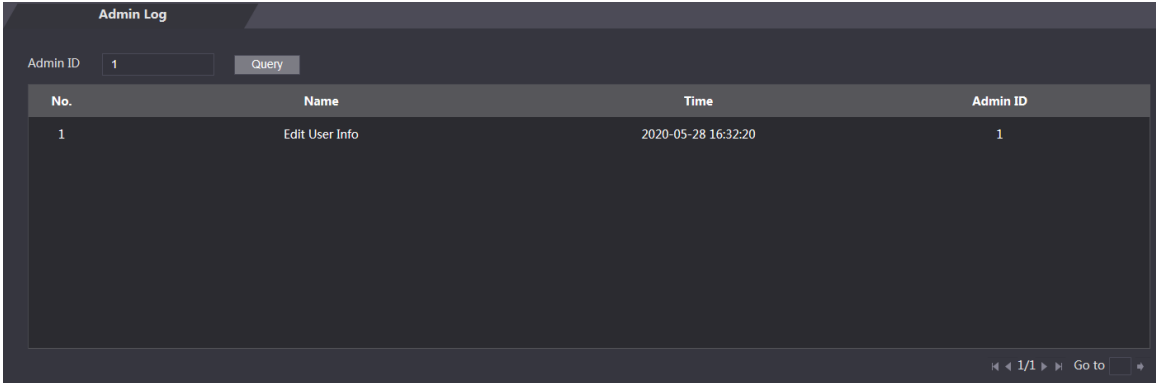

The screenshot shows the 'Admin Log' interface. At the top, there is a search bar with 'Admin ID' and a 'Query' button. Below the search bar is a table with the following data:

No.	Name	Time	Admin ID
1	Edit User Info	2020-05-28 16:32:20	1

At the bottom right of the table, there are navigation controls: a left arrow, '1/1', a right arrow, and a 'Go to' button with a text input field.

## 4.17 Exit

Click , click **OK**, and then you will log out the web interface.



# 5 SmartPSS AC Configuration

You can manage the access controller through the SmartPSS AC client. For detailed configurations, see the SmartPSS AC user manual.



SmartPSS AC interfaces might vary with versions, and the actual interface shall prevail.

## 5.1 Login

Step 1 Install the SmartPSS AC.



Step 2 Double-click , and then follow the instructions to finish the initialization and log in.

## 5.2 Adding Devices

You need to add access controllers to the SmartPSS AC. You can click **Auto Search** to add and click **Add** to manually add devices.

### 5.2.1 Auto Search

You can search and add access controllers at the same network segment to the SmartPSS AC.

Step 1 Log in to SmartPSS AC.

Step 2 Click **Device Manager** at the lower left corner, and the **Devices** interface is displayed.

Figure 5-1 Devices

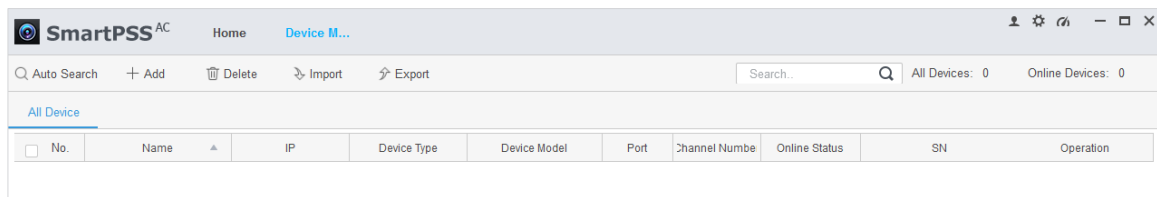

Step 3 Click **Auto Search**, and the **Auto Search** interface is displayed.

Figure 5-2 Auto search

Auto Search

Device Segment: [ ] - [ ] Search

Refresh Modify IP Initialization Search Device Number: 1

No.	IP	Device Type	MAC Address	Port	Initialization Status
<input type="checkbox"/> 1	[ ]	[\$[PRODUCT_NAME]]	[ ]	[ ]	<input checked="" type="checkbox"/> Initialized

Add Cancel

**Step 4** Enter the network segment, and then click **Search**.

A search result list will be displayed.

**Step 5** Select access controllers that you want to add to the SmartPSS AC, and then click **Add**.

The Login information dialog box will be displayed.

**Step 6** Enter the username and the login password to login.

You can see the added access controller on the **Devices** interface.



Select an access controller, click **Modify IP**, and you can modify the access controller's IP address. For details about IP address modification, see SmartPSS AC user manual.

## 5.2.2 Manual Add

You can add access controllers manually. You need to know IP addresses and domain names of access controllers that you want to add.

**Step 1** Log in to SmartPSS AC.

**Step 2** Click **Device Manager** at the lower left corner, and the **Devices** interface is displayed.

**Step 3** Click **Add** on the **Devices** interface, and the **Manual Add** interface will be displayed.

Figure 5-3 Manual add

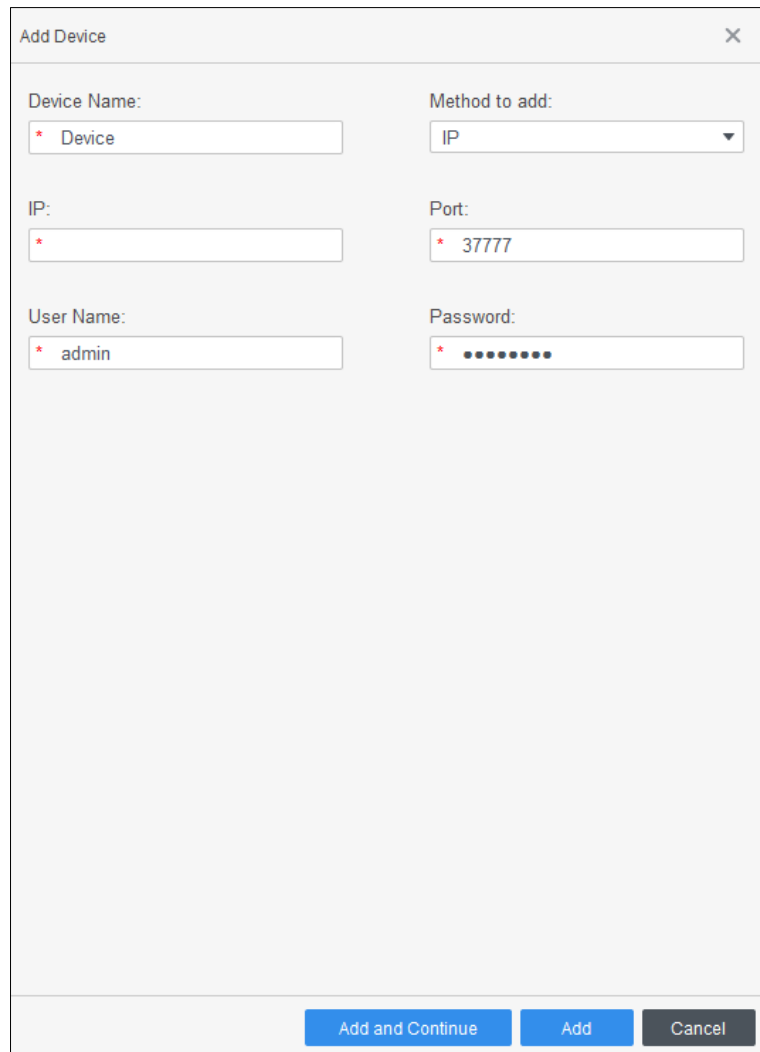

Step 4 Enter the Device Name, select a method to add, enter the IP, Port number (37777 by default), User Name, and Password.

Step 5 Click **Add**, and then you can see the added access controller on the **Devices** interface.

## 5.3 User Management

### 5.3.1 Card Type Setting

Before issuing card, set card type first. For example, if the issued card is ID card, select type as ID card.



Card types must be the same as card issuer types; otherwise card numbers cannot be read.

Step 1 Log in to SmartPSS AC.

Step 2 Click **Personnel Manager**, and the **Personnel Manager** interface is displayed.

Figure 5-4 Personnel manager

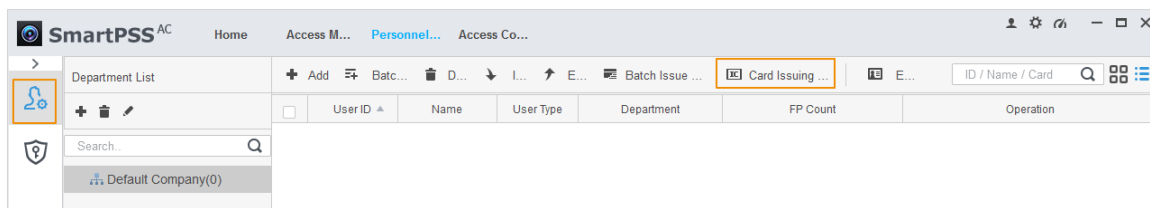

**Step 3** On the **Personnel Manager** interface, click , then click .

**Step 4** On the **Setting Card Type** interface, select a card type.

**Step 5** Click  to select display method of card number in decimal or in hex.

Figure 5-5 Setting card type

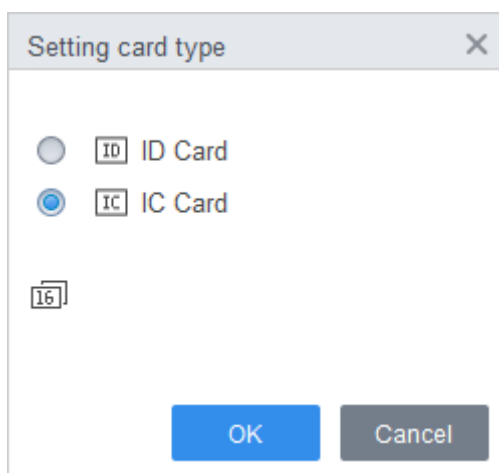

**Step 6** Click **OK**.

## 5.3.2 Adding User

Select one of the methods to add user.

- Add user one by one manually.
- Add user in batches.
- Extract user information from other devices.
- Import user information from the local.

### 5.3.2.1 Manual Add

You can add user one by one manually.

**Step 1** Log in to SmartPSS AC.

**Step 2** Click **Personnel Manger > User > Add**.

**Step 3** Add basic information of the user.

- 1) Click the **Basic Info** tab on the **Add User** interface, and then add basic information of the user.
- 2) Click the image, and then click **Upload Picture** to add a face image.

The uploaded face image will display on the capture frame.



Make sure that the image pixels are more than 500 x 500; image size is less than 120 KB.

Figure 5-6 Add basic information

**Add User**

Basic Info    Certification    Permission configuration

User ID: \* 2  
Name: \* test  
Department: Default Company  
User Type: General  
Valid Time: 2020/6/5 0:00:00  
2030/6/5 23:59:59    3653 Days

CameraCaptchPicture  
Upload Picture  
Image Size:0 ~ 120KB

**Details**

Gender:  Male     Female    ID Type: ID  
Title: Mr    ID No.:  
DOB: 1985-3-15    Company:  
Tel:    Occupation:  
Email:    Entry Time: 2020/6/4 14:37:59  
Mailing Address:    Resign Time: 2030/6/5 14:37:59  
Administrator:   
Remark:

Continue    Finish    Cancel

**Step 4** Click the **Certification tab** to add certification information of the user.

- Configure password.

Set password. For the second generation access controllers, set the personnel password; for other devices, set the card password. The new password must consist of 6 digits.

- Configure card.



The card number can be read automatically or filled in manually. For automatically read, select a card reader, and then place the card on the card reader. The card number is read automatically after that.



- 1) Click  to select **Device** or **Card issuer** as card reader.
  - 2) Add card. The card number must be added if the non-second generation access controller is used.
  - 3) After adding, you can select the card as main card or duress card, or replace the card with new one, or delete the card.
- Configure fingerprint.
- 1) Click  to select **Device** or **Fingerprint Scanner** as fingerprint collector.
  - 2) Add fingerprint. Click **Add Fingerprint** and press finger on the scanner three times continuously.

Figure 5-7 Configure certification

**Edit user** [Close]

Basic Info | **Certification** | Permission configuration

**Password** ..... [Edit] [Delete] [Warning] For the 2nd-generation access controller, it is the personnel password; otherwise it is card password.

---

**Card** [Add] [Warning] The card number must be added if not the 2nd generation access controller is used. [Settings]

00000010 [1]

Card Issuin... 2020-05-11

Card Repla... 2020-05-11

[1] [Refresh] [Refresh] [Delete]

---

**Fingerprint** [Settings]

[+ Add] [Delete]

<input type="checkbox"/>	Fingerprint Name	Operation
--------------------------	------------------	-----------

[Finish] [Cancel]

**Step 5** Configure permission for the user.  
For details, see "5.4 Permission Configuration".

Figure 5-8 Permission configuration

Basic Info    Certification    **Permission configuration**

Permission group is a combination of various devices including attendance check and access control. After selecting the permission group, the personnel info will be sent to corresponding device and used for related functions of access control and attendance check.

**Add Group**   

<input type="checkbox"/>	Permission Group	Memo
<input type="checkbox"/>	Permission Group1	
<input type="checkbox"/>	Permission Group2	

Step 6 Click **Finish**.

### 5.3.2.2 Batch Add

You can add users in batches.

Step 1 Log in to SmartPSS AC.

Step 2 Click **Personnel Manger > User > Batch Add**.

Step 3 Select card reader and the department of user. Set the start number, card quantity, effective time and expired time of card.

Step 4 Click **Issue** to start issuing cards.

The card number will be read automatically.

Step 5 Click **Stop** after issuing card, and then click **OK**.



Figure 5-9 Add user in batches

Batch Add ✕

Device  
Card issuer Issue

Start No.: \* 5      Quantity: \* 10

Department:  
Company\DepartmentB

Effective Time: 2020/4/30 0:00:00 📅      Expired Time: 2030/4/30 23:59:59 📅

Issue Card

ID	Card No.
5	
6	
7	
8	
9	
10	
11	
12	
13	
14	

OK      Cancel

Step 6 In the list of user, click  to modify information or add details of users.

### 5.3.2.3 Extracting User from Devices

You can extract user information from devices.

Step 1 Log in to SmartPSS AC.

Step 2 Click **Personnel Manger > User > Extract**.

Step 3 Search and select the target device, and then click **OK**.

Figure 5-10 Devices with user information

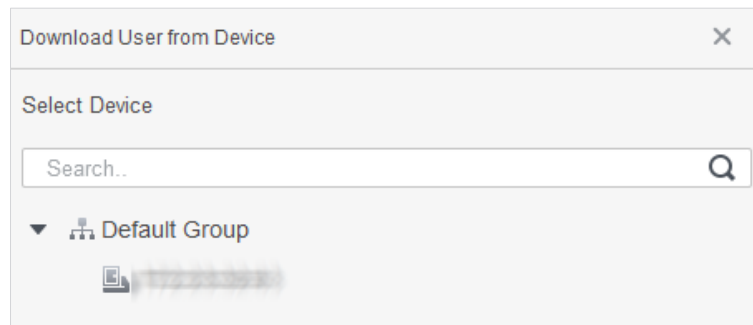

Step 4 Select users as needed, and click **Extract**.

Step 5 In the list of user, click  to modify information or add details of user.

### 5.3.2.4 Importing User

You can import users locally.

Step 1 Log in to SmartPSS AC.

Step 2 Click **Personnel Manger > User > Import**.

Step 3 Import user information according to instructions.

### 5.3.3 Issuing Card in Batches

You can issue cards to user who have been added but have no card.

Step 1 Log in to SmartPSS AC.

Step 2 Select **Personnel Manager > User**.

Step 3 Select users as needed and then click **Batch Issue Card**.

Step 4 Issue card in batches. Card No. can be auto read by card reader or entered manually.

- Auto read
  - 1) Select card reading device, and then click **Issue**.
  - 2) According to the card list, put the cards of the corresponding user on card reader in sequence, and then the system will auto read the card No..
  - 3) Modify user info, such as start time and end time for card validation.
- Enter manually
  - 1) Select user in card list and enter the corresponding card No..
  - 2) Modify user info, such as start time and end time for card validation.

Figure 5-11 Issue card in batches

Batch Issue Card

Device:

ID:  Name:

Card No.:  Department:

Start Time:  End time:

Card List

User ID	Name	Card No.	Operation
1	1		
2	2		
3	3		
5	5		
7	7		

Step 5 Click **OK**.

### 5.3.4 Exporting User Information

You can export user information.

Step 1 Log in to SmartPSS AC.

Step 2 Select **Personnel Manager > User**.

Step 3 Select the user information which needs to be exported, and then click **Export** to export all user information to local.

## 5.4 Permission Configuration

### 5.4.1 Adding Permission Group

Step 1 Log in to SmartPSS AC.

**Step 2** Click **Personnel Manger > Permission Configuration**.

Figure 5-12 Permission group list

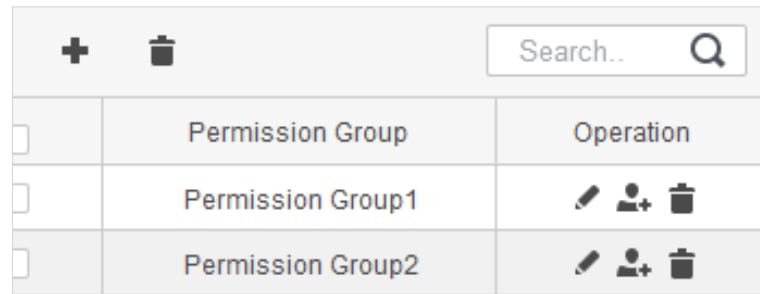

	Permission Group	Operation
<input type="checkbox"/>	Permission Group1	
<input type="checkbox"/>	Permission Group2	

**Step 3** Click  to add a permission group.

**Step 4** Set permission parameters.

- 1) Enter group name and remark.
- 2) Select the needed time template.



For details of time template setting, see SmartPSS AC user manual.

- 3) Select the corresponding device, such as door 1.

Figure 5-13 Add permission group

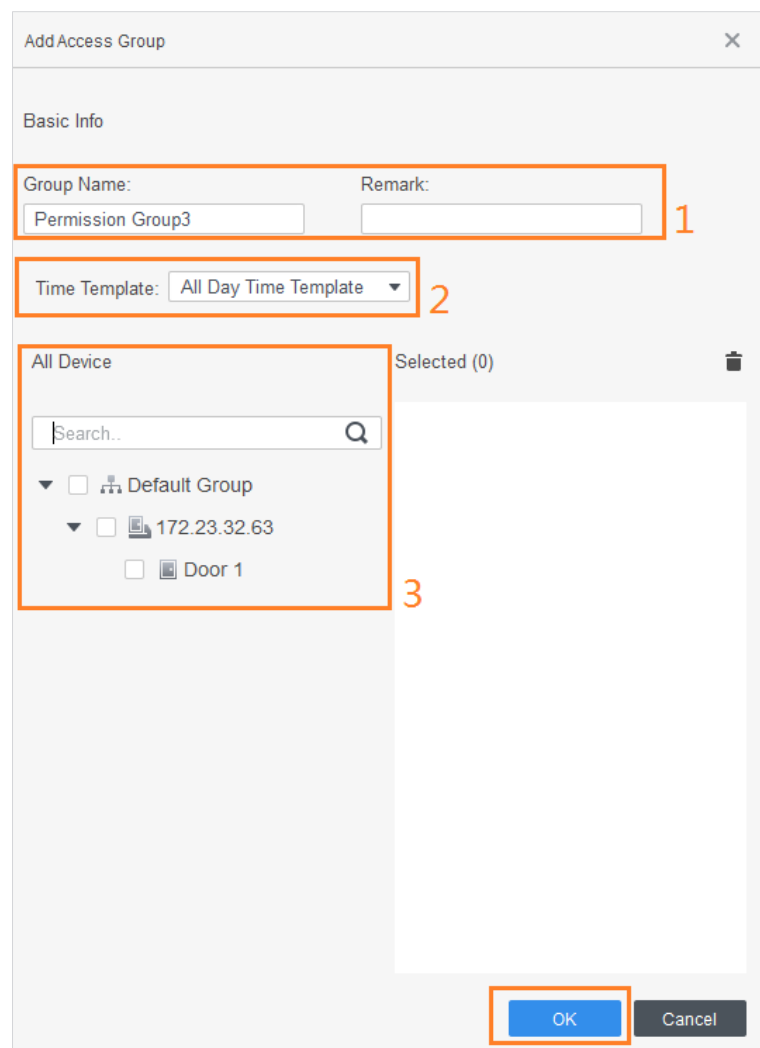

Add Access Group

Basic Info

Group Name:  Remark:

Time Template:

All Device

Selected (0)

Default Group



172.23.32.63

Door 1

**Step 5** Click **OK**.



On the **Permission Group List** interface, you can do:

- Click  to delete group.
- Click  to modify group info.
- Double-click permission group name to view group info.

## 5.4.2 Configuring Permission

The method to configure permission for department and for users is similar. This section takes users as an example.

Step 1 Log in to SmartPSS AC.

Step 2 Click **Personnel Manger > Permission Configuration**.

Step 3 Select the target permission group, and then click .

Figure 5-14 Configure permission

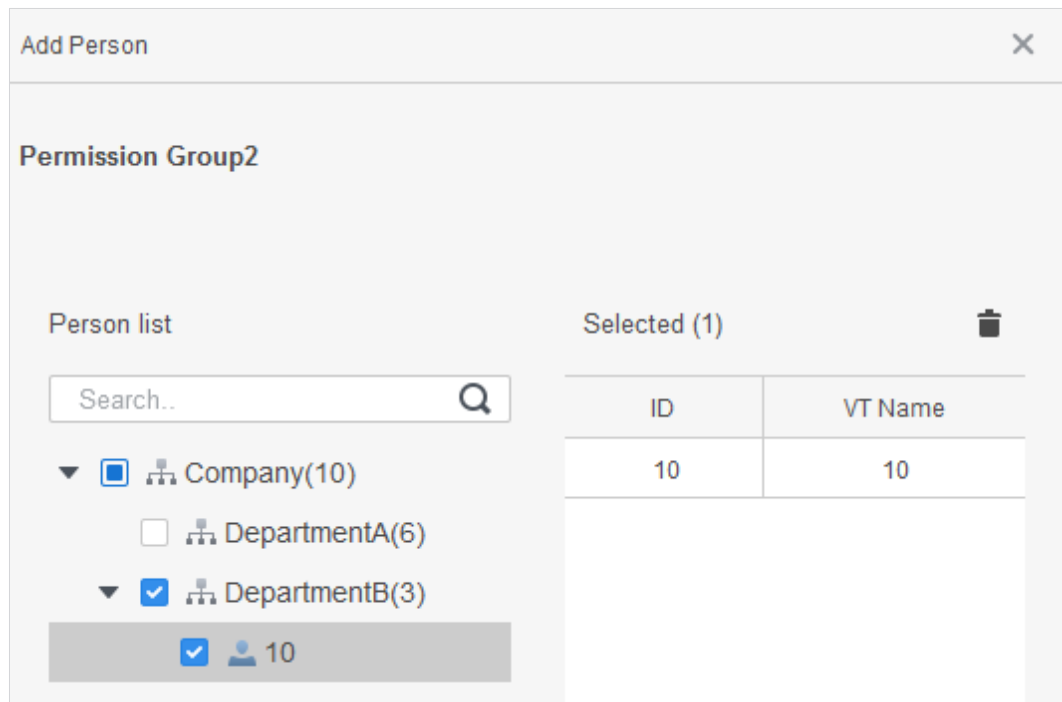

Step 4 Select the user need to be configured permission.

Step 5 Click **OK**.

## 5.5 Access Management

### 5.5.1 Remotely Opening and Closing Door

After access configuration, you can remotely control door through SmartPSS AC.

Step 1 Click **Access Manager** on the homepage. (Or click **Access Guide** > .

Step 2 Remotely control the door. There are two methods.

- Method 1: Select the door, right click and select **Open**.

Figure 5-15 Remotely control (method 1)

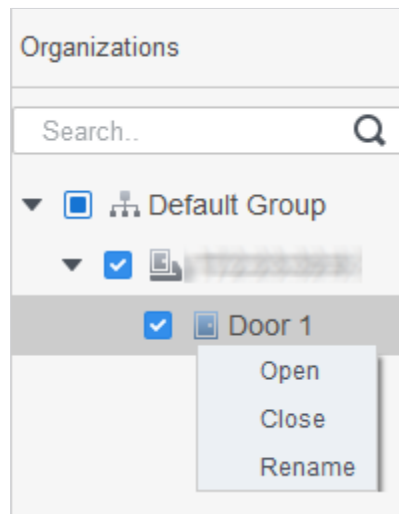



- Method 2: Click  or  to open or close the door.

Figure 5-16 Remotely control (method 2)



Step 3 View door status by **Event Info** list.



- Event filtering: Select the event type in the **Event Info**, and the event list displays events of the selected types. For example, select **Alarm**, and the event list only displays alarm events.
- Event refresh locking: Click  to the right of **Event Info** to lock or unlock the event list, and then the real-time events cannot be viewed.
- Event deleting: Click  to the right of **Event Info** to clear all events in the event list.

## 5.5.2 Setting Always Open and Always Close

After setting always open or always close, the door is open or closed all the time and cannot be controlled manually. If you want to manually control the door again, click **Normal** to reset the door status.

**Step 1** Click **Access Manager** on the homepage. (Or click **Access Guide** > .

**Step 2** Select the needed door, and then click **Always Open** or **Always Close**.

Figure 5-17 Set always open or always close

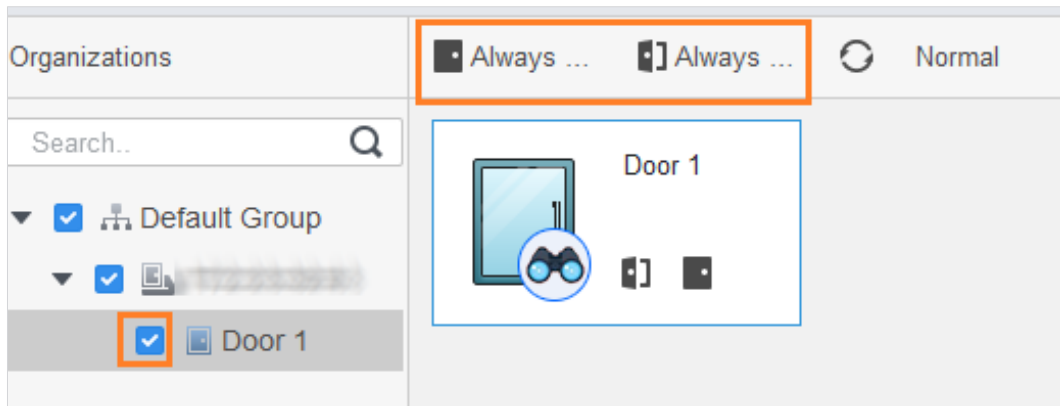

## 5.5.3 Resetting Door Status

Click **Normal** to reset the door status, if you want to manually control the door again when you have clicked **Always Open** or **Always Close**.

**Step 1** Click **Access Manager** on the homepage. (Or click **Access Guide** > .

**Step 2** Select the needed door, and then click **Normal**. And then follow the on-screen instructions to operate.

Figure 5-18 Reset door status

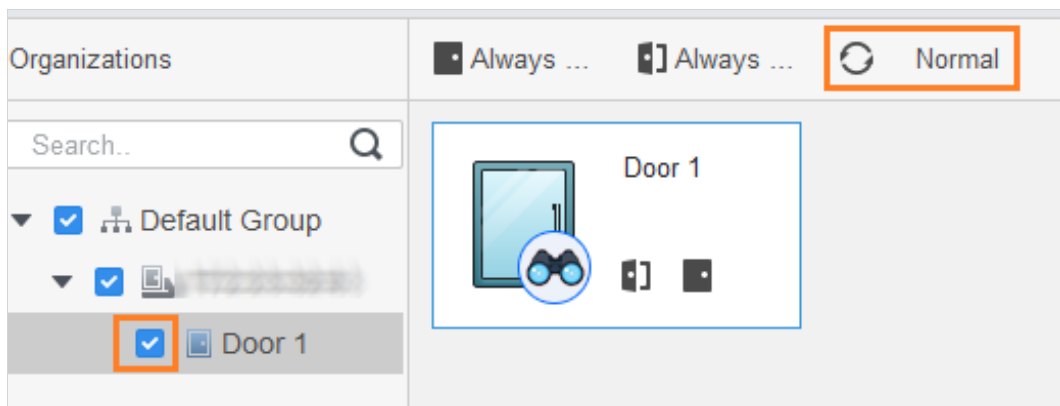

## 5.6 Attendance Management

You can set attendance time, add attendance shifts, personnel scheduling, process attendance, manage attendance statistics, search reports, add holidays, and configure attendance.

### 5.6.1 Report Search

You can view the normal attendance, attendance abnormality, overtime attendance and staff information here. And the statistics can be exported as reports.

**Step 1** Log in to SmartPSS AC.

**Step 2** Click **Attendance Manager**, and the **Attendance Manager** interface is displayed.

**Step 3** On the left menu bar, click .

**Step 4** Select the time, department and statistic type, to view the corresponding reports.

Figure 5-19 Report search

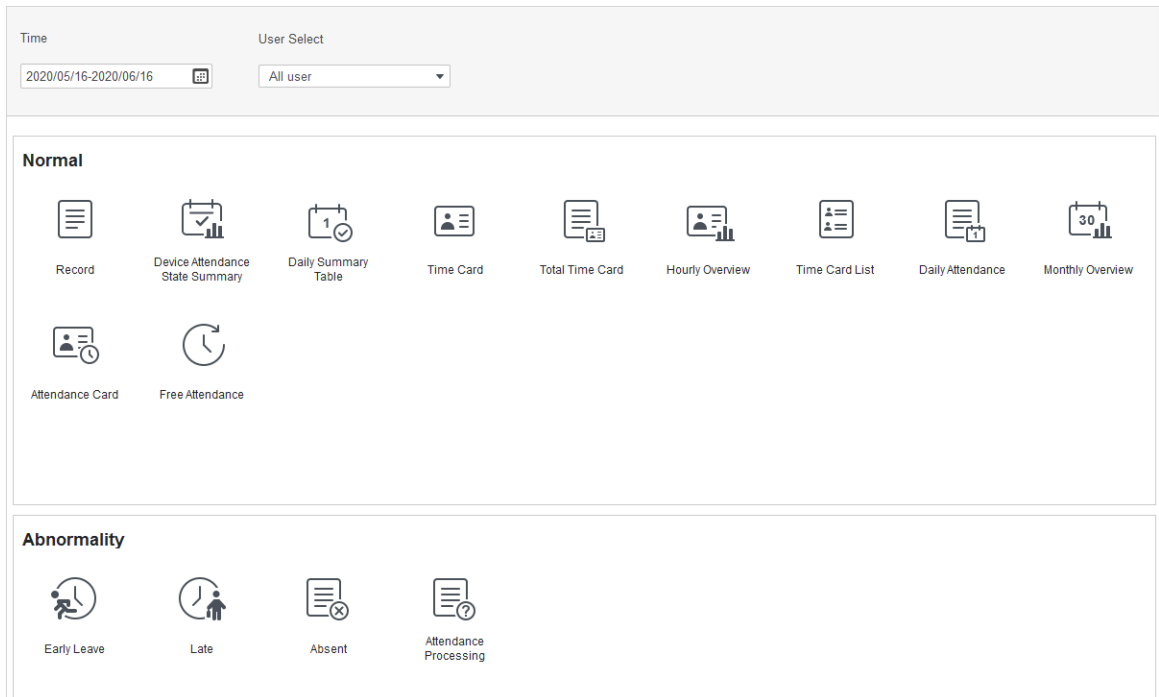

After the device is added and authenticated on the SmartPSS AC platform, the corresponding attendance status will be reported to the platform, and the platform will generate the corresponding attendance status report.

Figure 5-20 Attendance status report of the device

Default Company										
Device Attendance State Summary Report										
From 2020/05/16 to 2020/06/16										
Department		No Department								
Employee No.	Date	Away Time	Return Time	Total (Minute)	Card No.	Sign In	Sign Out	Total (Minute)	Overtime work sign in	Overtime work sign out
2	2020/06/16						17:14:55			



## 5.6.2 Other Configurations

For other configurations such as attendance periods, attendance shifts, personnel scheduling, attendance processing and attendance statistics, adding holidays and attendance configurations, refer to the SmartPSS AC user's manual.

**Step 1** Log in to SmartPSS AC.

**Step 2** Click  on the left menu bar, and the home page of the attendance solution is displayed.

**Step 3** Click **Attendance Guide** at the lower-right corner.

Figure 5-21 View SmartPSS AC user's manual

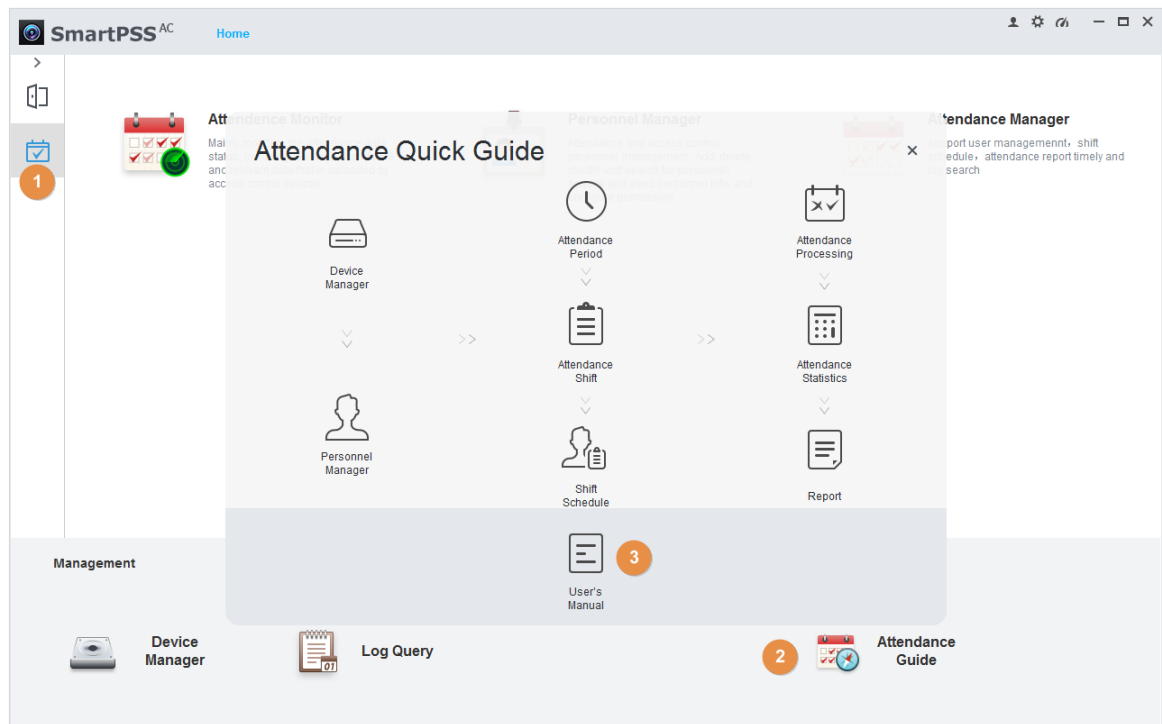

## 6 FAQ

- 1 The access controller fails to start after power-on.**

Check whether the 12V power supply is correctly connected, and whether the power button is pressed.
- 2 Faces cannot be recognized after the access controller powers on.**

Make sure that Face is selected in the unlock mode. See “3.8.2 Unlock”.  
Make sure that Face is selected as unlock mode in Access > Unlock Mode > Group Combination. See “3.8.2.3 Group Combination”.
- 3 There is no output signal when the access controller and the external controller are connected to the Wiegand port.**

Check whether the GND cable of access controller and the external controller are connected.
- 4 Configurations cannot be made after the administrator and password are forgotten.**

Delete administrators through the platform, or contact technical support to unlock the access controller remotely.
- 5 User information, and face images cannot be imported into the access controller.**

Check whether names of XML files and titles of tables were modified because the system will identify the files through their titles.
- 6 When a user’s face is recognized, but other users’ information is displayed.**

Make sure that when importing human faces, there are no other people around. Delete the original face, and import it again.

# Appendix 1 Notes of Face Recording/Comparison

## Before Registration

- Glasses, hats, and beards might influence face recognition performance.
- Do not cover your eyebrows when wearing hats.
- Do not change your beard style greatly if you will use the device; otherwise face recognition might fail.
- Keep your face clean.
- Keep the device at least two meters away from light source and at least three meters away from windows or doors; otherwise backlight and direct sunlight might influence face recognition performance of the device.

## During Registration

You can register faces through the access controller or through the platform. For registration through the platform, see the platform user manual.

Make your head center on the photo capture frame. A picture of your face will be captured automatically.

Appendix Figure 1-1 Registration

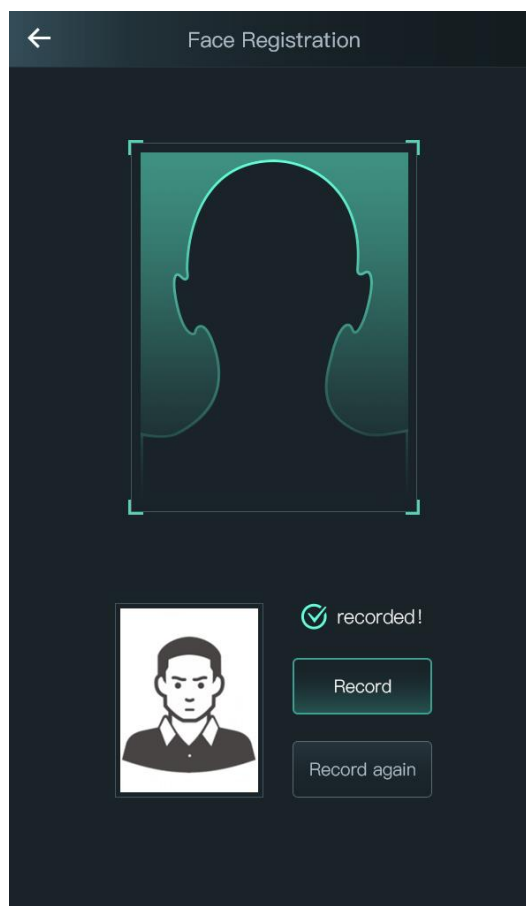



- Do not shake your head or body, otherwise the registration might fail.
- Avoid two faces appear in the capture frame at the same time.

## Face Position

If your face is not at the appropriate position, face recognition effect might be influenced.

Appendix Figure 1-2 Appropriate face position

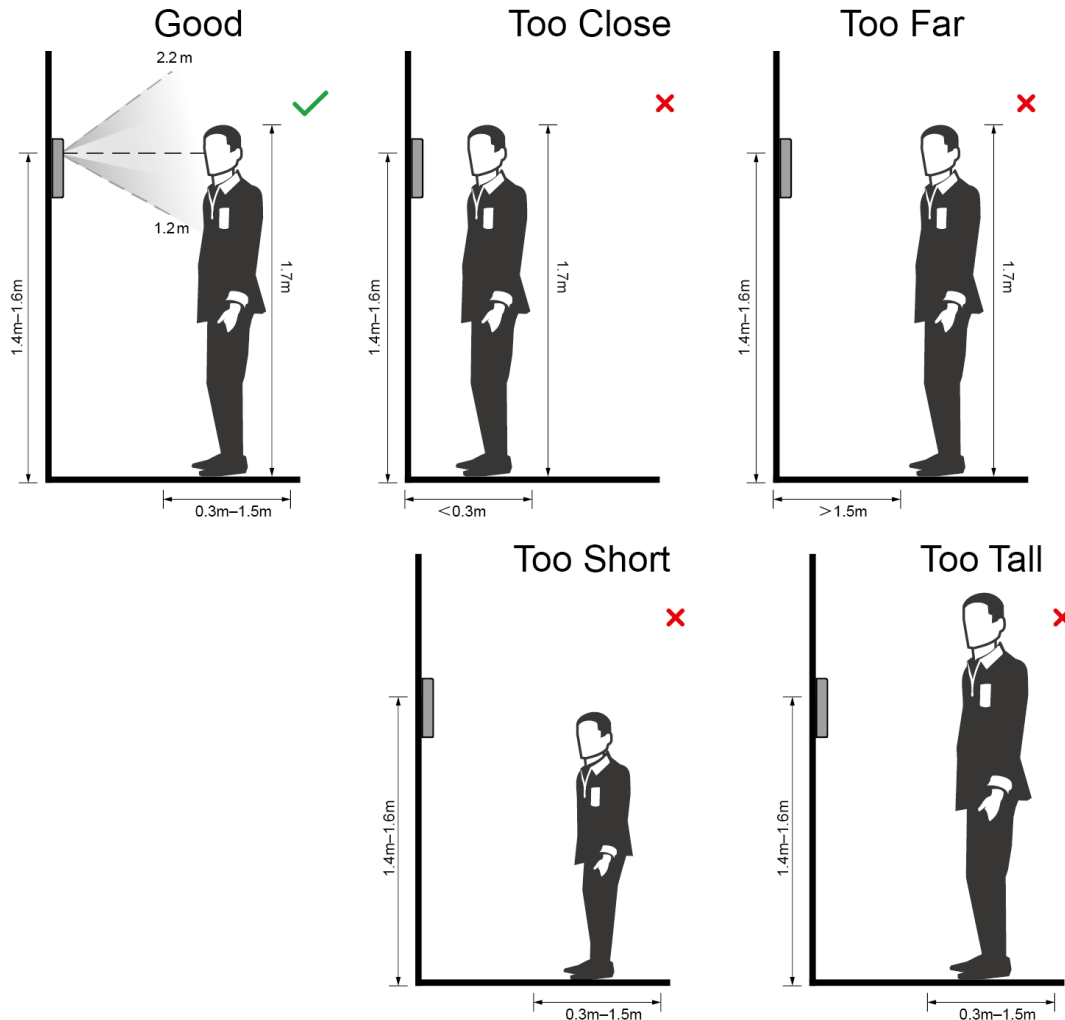

## Requirements of Faces

- Make sure that the face is clean and forehead is not covered by hair.
- Do not wear glasses, hats, heavy beards, or other face ornaments that influence face image recording.
- With eyes open, without facial expressions, and make your face toward the center of camera.
- When recording your face or during face recognition, do not keep your face too close to or too far from the camera.

Appendix Figure 1-3 Head position

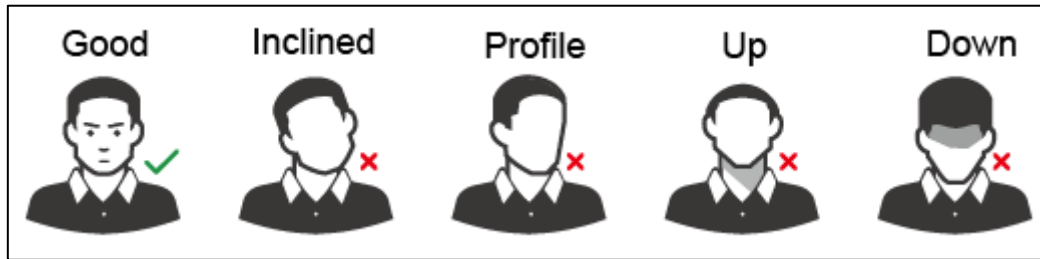

Appendix Figure 1-4 Face distance

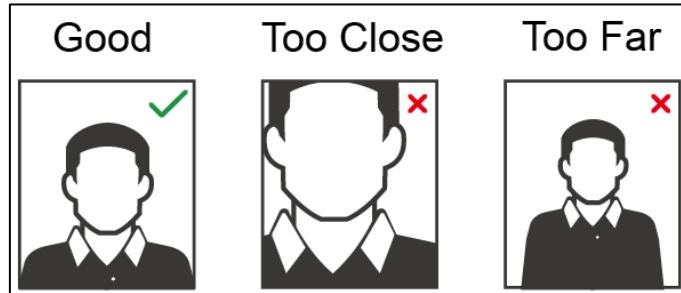

- When importing face images through the management platform, make sure that image resolution is within the range 150 × 300–600 × 1200; image pixels are more than 500 × 500; image size is less than 75 KB, and image name and person ID are the same.
- Make sure that face does not take 2/3 of the whole image area, and the aspect ratio does not exceed 1:2.

# Appendix 2 Cybersecurity Recommendations

Cybersecurity is more than just a buzzword: it's something that pertains to every device that is connected to the internet. IP video surveillance is not immune to cyber risks, but taking basic steps toward protecting and strengthening networks and networked appliances will make them less susceptible to attacks. Below are some tips and recommendations on how to create a more secured security system.

## **Mandatory actions to be taken for basic equipment network security:**

### **1. Use Strong Passwords**

Please refer to the following suggestions to set passwords:

- The length should not be less than 8 characters;
- Include at least two types of characters; character types include upper and lower case letters, numbers and symbols;
- Do not contain the account name or the account name in reverse order;
- Do not use continuous characters, such as 123, abc, etc.;
- Do not use overlapped characters, such as 111, aaa, etc.;

### **2. Update Firmware and Client Software in Time**

- According to the standard procedure in Tech-industry, we recommend to keep your equipment (such as NVR, DVR, IP camera, etc.) firmware up-to-date to ensure the system is equipped with the latest security patches and fixes. When the equipment is connected to the public network, it is recommended to enable the "auto-check for updates" function to obtain timely information of firmware updates released by the manufacturer.
- We suggest that you download and use the latest version of client software.

## **"Nice to have" recommendations to improve your equipment network security:**

### **1. Physical Protection**

We suggest that you perform physical protection to equipment, especially storage devices. For example, place the equipment in a special computer room and cabinet, and implement well-done access control permission and key management to prevent unauthorized personnel from carrying out physical contacts such as damaging hardware, unauthorized connection of removable equipment (such as USB flash disk, serial port), etc.

### **2. Change Passwords Regularly**

We suggest that you change passwords regularly to reduce the risk of being guessed or cracked.

### **3. Set and Update Passwords Reset Information Timely**

The equipment supports password reset function. Please set up related information for password reset in time, including the end user's mailbox and password protection questions. If the information changes, please modify it in time. When setting password protection questions, it is suggested not to use those that can be easily guessed.

### **4. Enable Account Lock**

The account lock feature is enabled by default, and we recommend you to keep it on to guarantee the account security. If an attacker attempts to log in with the wrong password several times, the corresponding account and the source IP address will be locked.

### **5. Change Default HTTP and Other Service Ports**

We suggest you to change default HTTP and other service ports into any set of numbers between 1024~65535, reducing the risk of outsiders being able to guess which ports you are using.

#### **6. Enable HTTPS**

We suggest you to enable HTTPS, so that you visit Web service through a secure communication channel.

#### **7. Enable Whitelist**

We suggest you to enable whitelist function to prevent everyone, except those with specified IP addresses, from accessing the system. Therefore, please be sure to add your computer's IP address and the accompanying equipment's IP address to the whitelist.

#### **8. MAC Address Binding**

We recommend you to bind the IP and MAC address of the gateway to the equipment, thus reducing the risk of ARP spoofing.

#### **9. Assign Accounts and Privileges Reasonably**

According to business and management requirements, reasonably add users and assign a minimum set of permissions to them.

#### **10. Disable Unnecessary Services and Choose Secure Modes**

If not needed, it is recommended to turn off some services such as SNMP, SMTP, UPnP, etc., to reduce risks.

If necessary, it is highly recommended that you use safe modes, including but not limited to the following services:

- SNMP: Choose SNMP v3, and set up strong encryption passwords and authentication passwords.
- SMTP: Choose TLS to access mailbox server.
- FTP: Choose SFTP, and set up strong passwords.
- AP hotspot: Choose WPA2-PSK encryption mode, and set up strong passwords.

#### **11. Audio and Video Encrypted Transmission**

If your audio and video data contents are very important or sensitive, we recommend that you use encrypted transmission function, to reduce the risk of audio and video data being stolen during transmission.

Reminder: encrypted transmission will cause some loss in transmission efficiency.

#### **12. Secure Auditing**

- Check online users: we suggest that you check online users regularly to see if the device is logged in without authorization.
- Check equipment log: By viewing the logs, you can know the IP addresses that were used to log in to your devices and their key operations.

#### **13. Network Log**

Due to the limited storage capacity of the equipment, the stored log is limited. If you need to save the log for a long time, it is recommended that you enable the network log function to ensure that the critical logs are synchronized to the network log server for tracing.

#### **14. Construct a Safe Network Environment**

In order to better ensure the safety of equipment and reduce potential cyber risks, we recommend:

- Disable the port mapping function of the router to avoid direct access to the intranet devices from external network.
- The network should be partitioned and isolated according to the actual network needs. If there are no communication requirements between two sub networks, it is

suggested to use VLAN, network GAP and other technologies to partition the network, so as to achieve the network isolation effect.

- Establish the 802.1x access authentication system to reduce the risk of unauthorized access to private networks.
- It is recommended that you enable your device's firewall or blacklist and whitelist feature to reduce the risk that your device might be attacked.