



# All-in-one Active Deterrence Camera

## User's Manual













# Foreword

## Model

CDMS8113 Series

## Safety Instructions

The following categorized signal words with defined meaning might appear in the manual.

Signal Words	Description
 <b>DANGER</b>	Indicates a high potential hazard which, if not avoided, will result in death or serious injury.
 <b>WARNING</b>	Indicates a medium or low potential hazard which, if not avoided, could result in slight or moderate injury.
 <b>CAUTION</b>	Indicates a potential risk which, if not avoided, may result in property damage, data loss, lower performance, or unpredictable result.
 <b>ESD</b>	Indicates electrostatic Sensitive Devices.
 <b>ELECTRIC SHOCK</b>	Indicates the danger of high voltage.
 <b>LASER RADIATION</b>	Indicates a laser radiation hazard.
 <b>MOVING FAN BLADES</b>	Indicates dangerous moving parts. Keep away from rotating fan blades.
 <b>MECHANICAL INJURY</b>	Indicates mechanical injuries caused by device parts.
 <b>TIPS</b>	Provides methods to help you solve a problem or save your time.
 <b>NOTE</b>	Provides additional information as the emphasis and supplement to the text.

## Terms

To simplify descriptions, some frequently cited functions and names in this manual have the following meanings:

- Unless otherwise specified, "device" in this document refers to "All-in-one Active Deterrence Camera".
- To keep the devices safe, IP addresses, MAC addresses, and serial numbers cited in this manual have all been modified.

## Revision History

<b>Version</b>	<b>Revision Content</b>	<b>Release Time</b>
V1.0.1	Modify the network port.	2024.03
V1.0.0	First release.	2021.09

# Important Safeguards and Warnings

This section introduces the proper way of using the device, and danger and property damage preventions. Before using the device, read this manual carefully. Follow the instructions and keep this manual properly for future reference.

## Operating Requirements

- Do not place the Device in a place exposed to sunlight or near the heat source.
- Keep the Device away from dampness, dust, or soot.
- Keep the Device on a stable place to prevent it from falling.
- Do not drop or splash liquid onto the Device, and make sure that there is no object filled with liquid on the Device to prevent liquid from flowing into it.
- Prevent foreign objects from entering the Device, which might result in damage.
- Put the Device in a well-ventilated place, and do not block the ventilation of it.
- Use the Device within the rated range of power input and output.
- Do not disassemble the Device.
- Transport, use, and store the Device under the allowed humidity and temperature conditions.
- Do not expose the Device to water or excessive moisture when washing the car. A failure to follow this instruction might result in short circuit, fire, or other malfunctions.
- The dust on the circuit board will cause short circuit, which affect the normal operation of the Device and even damage the Device. To make the Device work stably for a long time, please regularly use the brush to remove the dust from components, including circuit board, connectors, and chassis.
- Keep the Device installed horizontally and make sure the internal anti-vibration components work properly.
- After all the cables are connected, tie up the cables to avoid the dangers such as short circuit, heat and electric shock resulted from loose cables.
- Pay attention to grounding of camera, since poor grounding might lead to chip damage.

## Power Supply Requirements

- Use the battery properly to avoid fire, explosion, and other dangers.
- Replace the battery with that of the same type.
- Use locally recommended power cord in the limit of rated specifications.
- The appliance coupler is a disconnection device. Keep a convenient angle when using it.
- Take care to complete the circuit connection. A failure to follow this instruction might result in Device damage.
- Prevent short circuit from occurring on all external wiring parts.
- After all the lines connections are completed, you can start connecting power cable.
- Ensure the project is well grounded to avoid interference to video and audio signals and avoid electrostatic or induced voltage to damage the Device.
- Unplug the power cable before you remove the audio/video signal cable, RS-232 or RS-485 cable; otherwise these ports might be damaged.

# Content

<b>Foreword</b> .....	<b>I</b>
<b>Important Safeguards and Warnings</b> .....	<b>III</b>
<b>1 Product Introduction</b> .....	<b>1</b>
1.1 Overview .....	1
1.2 Function.....	1
<b>2 Installation</b> .....	<b>3</b>
2.1 Unpack and Check.....	3
2.2 Device Structure .....	3
2.2.1 Top Cover .....	3
2.2.2 Side Panel Ports.....	4
2.2.3 Interface Definition .....	4
2.2.4 Dimensions .....	7
2.3 Installation.....	7
2.3.1 Installing SIM Card.....	7
2.3.2 Installing TF Card.....	7
2.3.3 Installing GPS Antenna .....	8
2.3.4 Fixing Device .....	10
2.3.5 Connecting Power Cable.....	10
2.4 Alarm Input and Output Connection .....	12
2.4.1 Alarm Input/Output Port Introduction.....	13
2.4.2 Alarm Input Port Description .....	13
<b>3 Basic Configuration</b> .....	<b>15</b>
3.1 Starting Device.....	15
3.2 Initializing Device.....	15
3.3 Logging in to Device.....	17
3.4 Configuring IP Address .....	19
3.5 Configuring General Setting.....	21
3.5.1 Basic .....	21
3.5.2 Date&Time.....	22
3.6 Configuring Record Mode .....	24
3.7 Configuring Storage Plan.....	25
3.7.1 Record Schedule .....	25
3.7.2 Snapshot Schedule .....	27
<b>4 Function Operations</b> .....	<b>30</b>
4.1 Live .....	30
4.1.1 Real-time Monitoring Channels .....	31
4.2 Video Playback.....	32
4.2.2 Control Bar.....	33
4.2.3 Playing Back Recorded Video Files .....	34
4.2.4 Clipping Recording File .....	35
4.3 Alarm Info .....	36
<b>5 System Settings</b> .....	<b>38</b>

---

5.1 Configuring Alarm Events.....	38
5.1.1 Video Detection.....	38
5.1.2 Alarm Input.....	42
5.1.3 Exception.....	44
5.1.4 Alarm Output.....	46
5.2 Configuring AI Plan.....	47
5.2.1 ADAS.....	47
5.2.2 DSM.....	50
5.3 File Backup.....	52
5.4 Configuring Camera Parameter.....	54
5.4.1 Camera Properties.....	54
5.4.2 Encode Parameters.....	55
5.5 Configuring Network Parameters.....	59
5.5.1 Port.....	59
5.5.2 Wireless Network.....	61
5.5.3 3G/4G.....	64
5.5.4 Email.....	66
5.5.5 Register.....	68
5.5.6 P2P.....	68
5.6 Managing Storage Device.....	69
5.6.1 Basic.....	70
5.6.2 Disk Manager.....	71
5.6.3 FTP.....	71
5.7 Configuring System.....	73
5.7.1 Configuring Serial Port Parameters.....	73
5.7.2 Managing Security.....	74
5.7.3 Configuring Vehicle Info.....	75
5.8 Managing User Account.....	78
5.8.1 Managing User.....	79
5.8.2 Managing Group.....	81
5.8.3 Resetting Password.....	82
<b>6 Update.....</b>	<b>85</b>
6.1 System Version.....	85
6.2 Update.....	85
<b>7 System Maintenance.....</b>	<b>87</b>
7.1 Requirement for Maintenance.....	87
7.2 System Information.....	87
7.2.1 Log.....	87
7.2.2 Network Info.....	88
7.2.3 Disk.....	88
7.2.4 Channel Info.....	89
7.2.5 Satellite Info.....	89
7.3 Automatic Maintenance.....	90
7.3.1 Auto Reboot.....	90
7.3.2 Auto Boot up.....	91
7.3.3 Auto Shutdown System.....	91

---

---

7.3.4 Acc Delay.....	91
7.4 Backup and Restore.....	92
7.4.1 Backing up Configurations.....	92
7.4.2 Importing Configurations.....	92
7.4.3 Restoring to Default.....	93
7.5 Network Sniffer .....	95
<b>8 Logging in to the Device from DSS.....</b>	<b>96</b>
<b>Appendix 1 FAQ.....</b>	<b>97</b>
<b>Appendix 2 Storage Capacity Calculation .....</b>	<b>100</b>
<b>Appendix 3 Legal Information .....</b>	<b>101</b>
<b>Appendix 4 Cybersecurity Recommendations.....</b>	<b>103</b>

# 1 Product Introduction

## 1.1 Overview

Developed on the new-generation platform, the all-in-one active deterrence camera is mobile video monitoring products that integrate video capturing, locating, drive recording and intelligent analysis functions.

It has the following features:

- Up to 3 HDCVI video input channels and 1 built-in DSM video input channel.
- The use of H.264/H.265 encoding ensures high encoding efficiency and saves storage space.
- The needs of using the mobile products in different networks are taken into full consideration in product design and 3G/4G modules or Wi-Fi modules are available.
- The use of professional in-vehicle design in standard size features low power consumption and novel shape.
- Wide power voltage range adapts to various in-vehicle power supply.
- Unique TF card storage design makes recording backup and management easier.

This product can be widely used for in-vehicle monitoring in public transportation, long-range passenger transport, police patrol, urban management patrol, cash carriers, hazardous goods transport, and logistics transport, or video monitoring in harsh environment.

## 1.2 Function

Table 1-1 Function Description

Function	Description
Storage	Stores the data in the dedicated format which cannot be falsified to ensure the data security.
Dual Stream	To cope with the low-bandwidth and instability of wireless network, the device adopts the dual-stream technology (encode real-time video and the video in network transmission separately) to optimize the encoding of network transmission, which improves the control capability of wireless network transmission.
Video Playback	<ul style="list-style-type: none"><li>• Every channel takes recording in real time and independently, and you can play backward, monitor through network, search and download recordings.</li><li>• Supports several playback modes: Slow playback, fast playback, backward playback, and frame-by-frame playback.</li><li>• Displays the accurate time when the event occurred during playback.</li></ul>
Backup	<ul style="list-style-type: none"><li>• Plug in a USB storage device (such as USB flash drive and mobile HDD) to back up the data.</li><li>• You can back up the data by downloading the files from the memory disk of the device (such as TF card and USB flash drive) through the network.</li></ul>



Function	Description
Alarm Linkage	<ul style="list-style-type: none"> <li>● Provides 4-channel electric level alarm inputs that can connect to signals such as car door signal, cornering lamp signal, reversing and braking signal, to give an indication and take a record.</li> <li>● Supports one route of electric level alarm output to realize easy alarm linkage.</li> <li>● Protective circuit for alarm input and output ports to prevent device from damage.</li> </ul>
Rollover and collision detection	Provides rollover and collision detection and timely releases alarms through the platform.
Operation through network	Supports remote operations through network, such as real-time remote monitoring, video recording search and playback, and PTZ remote control.
3G/4G, Wi-Fi	Adopts the latest wireless communication technology, which has improved the manageability of the device.
Communication interface	<ul style="list-style-type: none"> <li>● Offers RS-485 port to connect with external devices.</li> <li>● Offers RS-232 port to connect with external in-vehicle display.</li> <li>● Offers standard Ethernet ports that support remote network access.</li> </ul>
Compression	Supports multi-channel audio and video signals, and each channel signal supports real-time compression by independent hardware to realize the sync between sound and image.
Satellite positioning	Positioning history and recording linkage are available. Recording search can be linked with vehicle moving track.

## 2 Installation

This chapter introduces how to install the hardware of the device. Before installation, you need to know the device information, such as top cover, side, dimensions, and ports. After obtaining a sufficient understanding, you can install the SIM card, TF card, antenna and the device itself as needed.

### 2.1 Unpack and Check

When you receive the device, unpack the box for checks.

Firstly, check if there is any damage on the device appearance (although the packing materials are specially selected for protecting the device from most of accidental hit during transportation). Secondly, open the accessory box to check if the accessories are complete against the packing list.

Instructions about labels:

The labels on the device are very important for our after-sales service. To ensure the after-sales service, **keep the labels well, and do not tear or throw away**. You need to provide the serial number of the product when calling the after-sales service.

### 2.2 Device Structure

#### 2.2.1 Top Cover

Describes the functions of the front indicators and ports.

Figure 2-1 Top cover

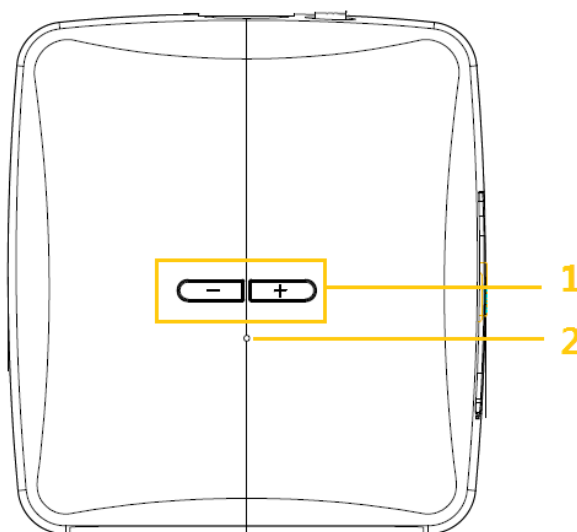

Table 2-1 Descriptions of ports and indicators

No.	Name	Descriptions
1	Volume Button	Press "+" to turn up the volume and "-" to turn down the volume.

No.	Name	Descriptions
2	Indicator Light	<ul style="list-style-type: none"> <li>● Blue light: Recording status indicator                             <ul style="list-style-type: none"> <li>◇ Flashing: Recording is normal.</li> <li>◇ Solid blue: The camera is not recording.</li> </ul> </li> <li>● Red Light: Connection status of GPS/4G                             <ul style="list-style-type: none"> <li>◇ Flashing: The connection of GPS or 4G is abnormal.</li> <li>◇ Solid red: The connection of GPS and 4G is all abnormal.</li> <li>◇ Light off: The connection of GPS and 4G is all normal.</li> </ul> </li> </ul>

## 2.2.2 Side Panel Ports

Describes the ports functions of the side panel.

For the ports of the side panel, see Figure 2-2, Table 2-2 for ports function description, and “2.2.3 Interface Definition” for ports definitions.

Figure 2-2 Side panel ports

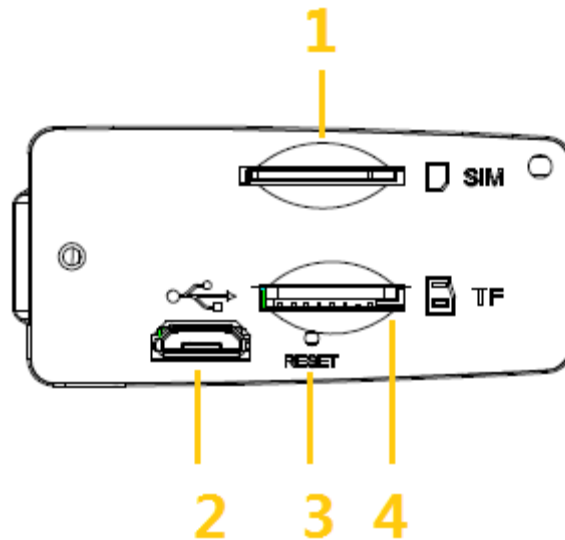

Table 2-2 Side panel port description

No.	Name	Function
1	SIM card port	Insert SIM card.
2	USB port	Connect the USB through a adapter cable.
3	RESET button	Button for device reset.
4	TF card port	Insert TF card.

## 2.2.3 Interface Definition



This manual only describes functions of each ports. You can follow these descriptions to prepare cables or contact our sales staff for purchasing cables.

### 2.2.3.1 Video Input

Figure 2-3 Video input

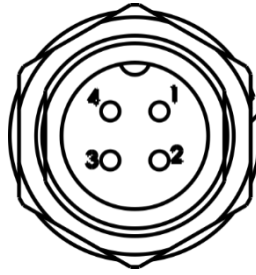

Table 2-3 Description

Name	Description
1	VCC
2	Signal ground
3	Power ground
4	Signal

### 2.2.3.2 Alarm Screen Ports

Figure 2-4 Alarm screen ports

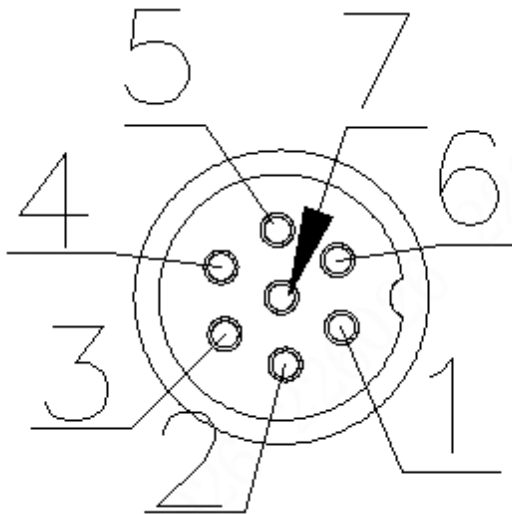
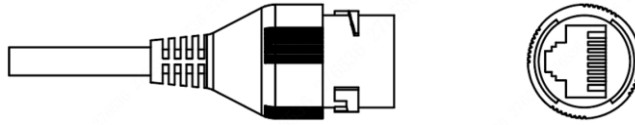

Table 2-4 Description

Name	Description
1	12V
2	GND
3	RS232_RX
4	RS232_TX
5	GND
6	NC
7	NC

### 2.2.3.3 Network Port

Figure 2-5 Network port(RJ45)



### 2.2.3.4 Power Input

Figure 2-6 Power input port

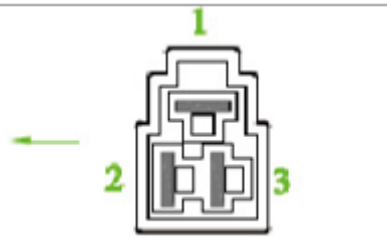

Table 2-5 Power input port description

Name	Pins	Cable Color
1	Ground	Black
2	ACC signal input	Orange
3	Anode input	Red

Table 2-6 Cable Description (1)

Color	Pins
Yellow	RS485+
Orange	RS485-
Blue	CAN_H
Green	CAN_L
Brown	RS232_TX
White	RS232_RX
Purple	RS232_GND

Table 2-7 Cable Description (2)

Color	Pins
Brown	Alarm output
Green	Alarm input 1
Blue	Alarm input 2
White	Alarm input 3
Yellow	Alarm input 4

## 2.2.4 Dimensions

Figure 2-7 Dimension (Unit: mm [inch])

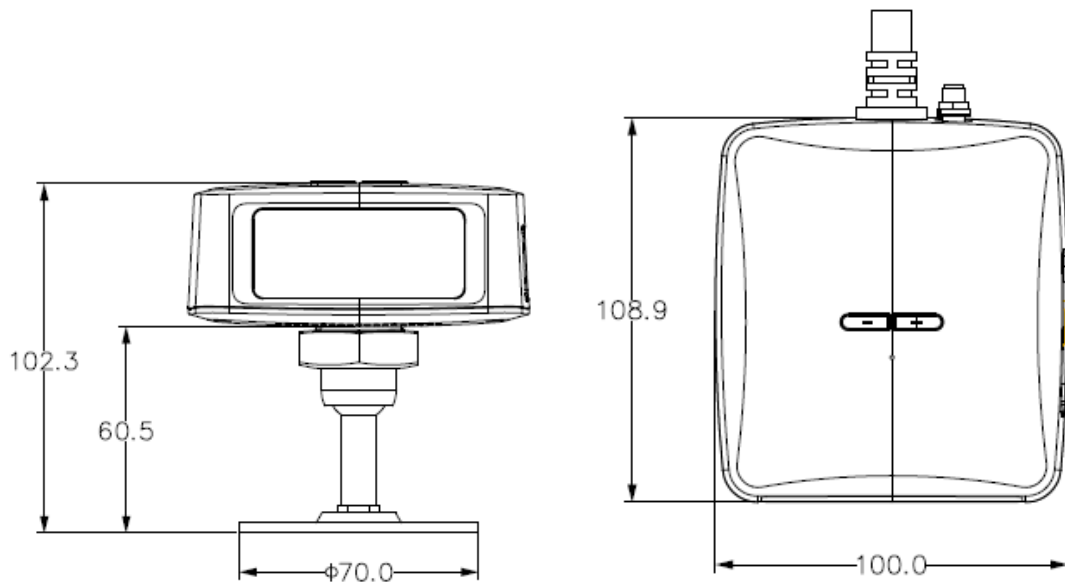

## 2.3 Installation

When you receive the Device, unpack the box to check the device appearance and structures, and then install SIM card and other items according to your network situation and storage requirement.



Before the installation is complete, make sure the device is disconnected from power, and do not plug or unplug components when the power is connected.

### 2.3.1 Installing SIM Card

The SIM card is not provided with the device by default. To connect the device to network through dial-up connection, you need to purchase and install a SIM card.



Only supports the standard SIM cards.

**Step 1** Disassemble the SIM card cover.

**Step 2** Insert the SIM card into the card slot with corresponding marks.

**Step 3** Push the SIM card slot back to the device.

### 2.3.2 Installing TF Card

The TF card is not provided with the device by default. Please purchase and install it if needed.

## Precondition

Make sure the device is disconnected from power source.

## Procedure

The TF card slot is inside the device, do the following to install the TF card.

Step 1 Disassemble the TF card cover.

Step 2 Insert the TF card into the card slot with corresponding marks. See Figure 2-8.

Figure 2-8 Installing TF card



Step 3 Reassemble the TF card and card slot. Fix the card cover with screws.

## 2.3.3 Installing GPS Antenna

The device antenna is installed to connect the device to the network and to locate the position of the vehicle.

Positioning methods include the currently mainstream GPS positioning, Beidou positioning, with corresponding GPS antenna and Beidou antenna.

In this document, GPS antenna is used as an example to illustrate the installation steps of locating antennas. The installation process of other locating antenna is identical.

### 2.3.3.1 Outside Installation

Step 1 Place the GPS antenna on the left front of the roof. See Figure 2-9.

The antenna is magnetically attached to the roof of the vehicle. Glue can be applied to four sides of the GPS antenna to fix more reliably.



To make the sensitivity and accuracy of positioning free of interference, ensure that there is no high-power electrical or electronic interference source (such as a fan or AC compressor) or obstacles within 1 meter around the GPS antenna.

Step 2 Insert the GPS antenna lead wire into the antenna lead hole on the roof of the vehicle and connect to the GPS antenna port inside the vehicle.

The requirements of the GPS antenna lead hole are as follows.

- The inner radius is at least  $\varnothing 10\text{mm}$ .
- It must be waterproof.
- Easy to replace and maintain the antenna.

Figure 2-9 Outside installation



### 2.3.3.2 Inside Installation

When limited by waterproof and wiring requirements, the antenna can be installed inside the vehicle. To select the installation place, it is recommended to place the antenna horizontally on the dashboard close to the windshield, and make the GPS cable facing upward to enhance the signal, as shown in Figure 2-10.

Figure 2-10 Inside installation





## 2.3.4 Fixing Device



- Install the device on the vehicle where it cannot be seen from outside. Avoid places with high temperature or near the air conditioning system. High temperature shortens the life of the device. If the device is too close to the air conditioner, the condensing water from the air conditioner can short circuit or burn the device.
- Power on the camera only after all external devices are connected correctly to it.

**Step 1** Fix the camera onto the vehicle.

- 1) Punch holes on the vehicle according to the installation dimensional drawing.
- 2) Use screws to fix the device onto the vehicle.

**Step 2** Connect cables to the device.

- Check the voltage of the accumulator. The working voltage of this device ranges from 7V to 36V. To make sure the device works stably, directly get power supply from the accumulator.
- When installing the basic wires, do not use excessive force to pull the control wires.

## 2.3.5 Connecting Power Cable



- Before connecting the power cable, confirm whether the input voltage is between 7V–36V DC. If it is out of the range, it will damage the device.
- Please make sure that the positive and negative poles of the power are connected correctly. If not, the device may be damaged.
- The diameter of the power cable should be more than 1.0mm<sup>2</sup>. Use power cables recommended by our company.
- When connecting the cables to the device, make sure that the main power switch of the vehicle is turned off and the key of the vehicle is placed in the off state.

### 2.3.5.1 Overview

For the power cable of the device, see Figure 2-11.

Connect one end of the power cable to the power port of the device (the left port in the figure), connect the other end to the vehicle battery (the right port in the figure).

- The red one with fuse is positive pole of the power (always-live wire).
- The black one is the grounding cable.
- The orange one is the ACC signal (key starting wire).

Figure 2-11 Power cable

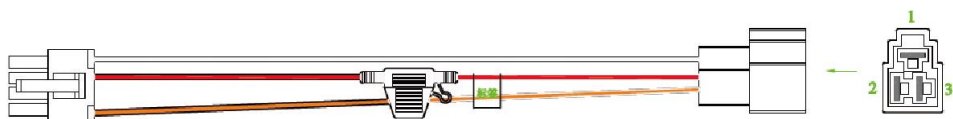

### 2.3.5.2 Obtain Connection Modes

In order to ensure correct cable connection, it is necessary to obtain the connection mode of the main power switch through three methods.

- Ask the vehicle manufacture the connection modes of the main power switch of the vehicle.
- Measure with a multimeter: disconnect the main switch, then measure the voltage between the vehicle body and the positive pole of the vehicle battery. If the voltage is 12V or 24V, it means that the main switch disconnects the positive pole. If the voltage is 0V, then the main switch disconnects the negative pole.
- Visual inspection: whether the switch cable near the vehicle battery is connected to the positive pole or the negative pole.

### 2.3.5.3 Connecting Operation

The camera must be connected to the ground wire, ACC signal, and constant electricity.

**Step 1** Enable the main power switch on the vehicle, place the key in the OFF state, and then measure the normal live electricity of the vehicle.

Use a multimeter to measure the voltage on the fuse by switching to the DC voltage range. When the multimeter detects voltage, it measures the normal live electricity on the vehicle. Generally, the voltage is 24V DC for large vehicles and 12V DC for small vehicles. However, this is subject to actual data.

**Step 2** When the vehicle key is placed at the ACC state or the ON state, the ACC signal of the vehicle is measured.

Use a multimeter to measure the voltage on the fuse by switching to the DC voltage range. When the multimeter detects voltage, remove the car key. If the voltage changes to 0V, it means that the measured signal is ACC on the car.

**Step 3** Turn off the main power switch on the vehicle, and place key in the OFF state.

**Step 4** Connect the power cable according to the main power switch installation mode. See Figure 2-12 and Figure 2-13.



- The positive and negative poles of the battery must be equipped with protective devices such as fuses.
- For vehicles where the master power switch is installed at the cathode of the accumulator, isolation installation is needed.

Figure 2-12 Vehicle main power switch installed on the positive pole of the vehicle battery

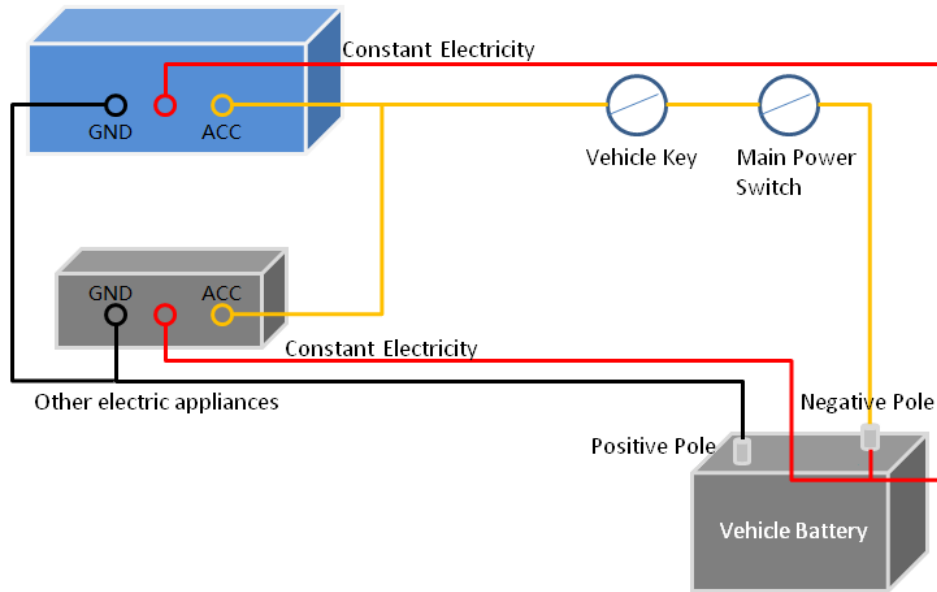
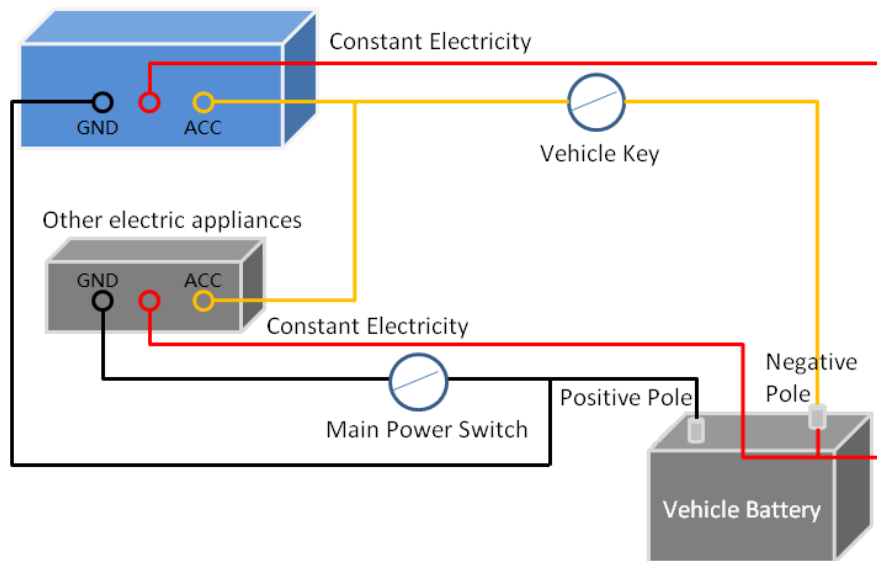

Figure 2-13 Vehicle main switch installed on the negative pole of the vehicle battery



## 2.4 Alarm Input and Output Connection

Before using the alarm function, learn about the connections method of alarm input and output port.

### Alarm Input

- The alarm input port supports alarm signal from ground and device of 12V-24V voltage.
- If the alarm device is connected to the device and other devices, use relay for isolation.

## Alarm Output

The alarm output port cannot be connected to high-power load (less than 1A). When constructing the output circuit, the excessive current should be prevented from causing damage to the relay. Use the contactor for isolation when applying high-power loads.

## No Restriction for Types of Alarm Input

The alarm input can be Normal Open or Normal Closed.

### 2.4.1 Alarm Input/Output Port Introduction

Describes alarm input and output ports.

Figure 2-14 Alarm Input/output Ports

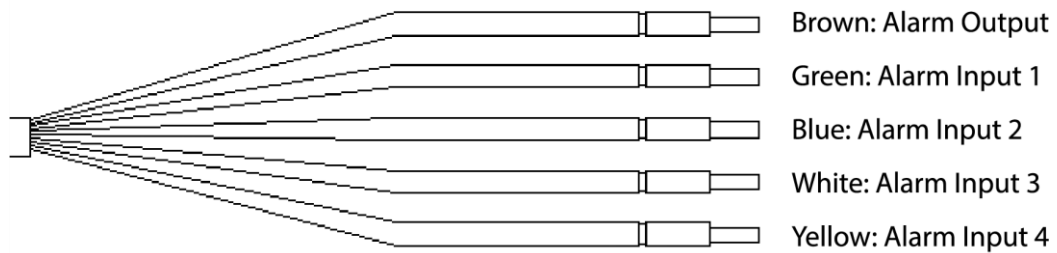

Table 2-8 Alarm input ports description

Name	Description
Alarm Output Port	Alarm output port that outputs alarm signal to alarm device.
Alarm Input Port	Alarm In 1–4, local alarm input port.

### 2.4.2 Alarm Input Port Description

- Both NO and NC are supported.
- The GND of alarm detector is in parallel connection with COM (the power supply of alarm detector should be from external power source). See Figure 2-15.
- The GND of alarm detector is in parallel connection with GND of device.
- Connect the NC port of alarm detector to the alarm input port (ALARM).
- When supplying power from external power source to the alarm device, the alarm device should be common-grounded with the device.

Figure 2-15 NC alarm input illustration

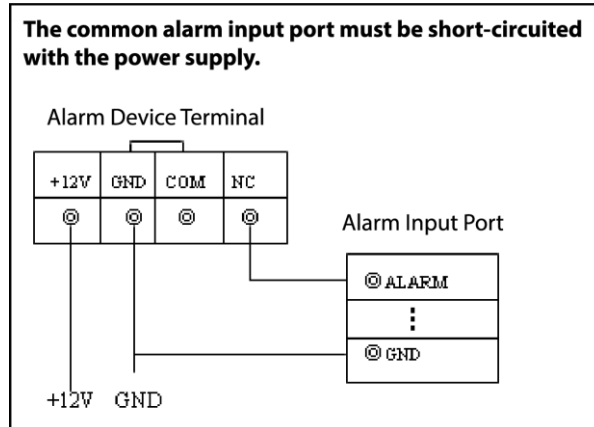

## 3 Basic Configuration

This device can be operated following instructions on the APP or WEB interface. This section introduces the WEB interface instructions. The local interface is similar and would not be elaborated here.



- There are several browsers are supported, including Safari, Firefox, and IE.
- Click **Refresh**, the system displays the latest saved configuration.

### 3.1 Starting Device



- Before turning on the device, check whether the input voltage is correct against the device power requirement.
- To ensure the stable work of the device and the external devices connected to the device and to prolong the service life, we recommend that you should refer to the national related standard to use the power source that provides stable voltage with less interference from ripples.
- In the first power-on, the device needs connection to the ACC to work as intended.



For the first boot up or after restoring to the default factory settings, the initialization interface is displayed on the screen. Follow on-screen instructions to initialize your device prior to use.

### 3.2 Initializing Device

When you are opening the device for the first time or you have allowed your system to be restored the factory settings, you need to initialize the device. Only after that can you operate and configure your device.

#### Prerequisites

Please make sure the correct network connection between PC and the device.

#### Procedure

- Step 1** Open the browser, enter the Device IP address (the default IP address is 192.168.1.108), and then press **Enter**.  
The **Device Initialization** interface is displayed. See Figure 3-1.

Figure 3-1 Device initialization

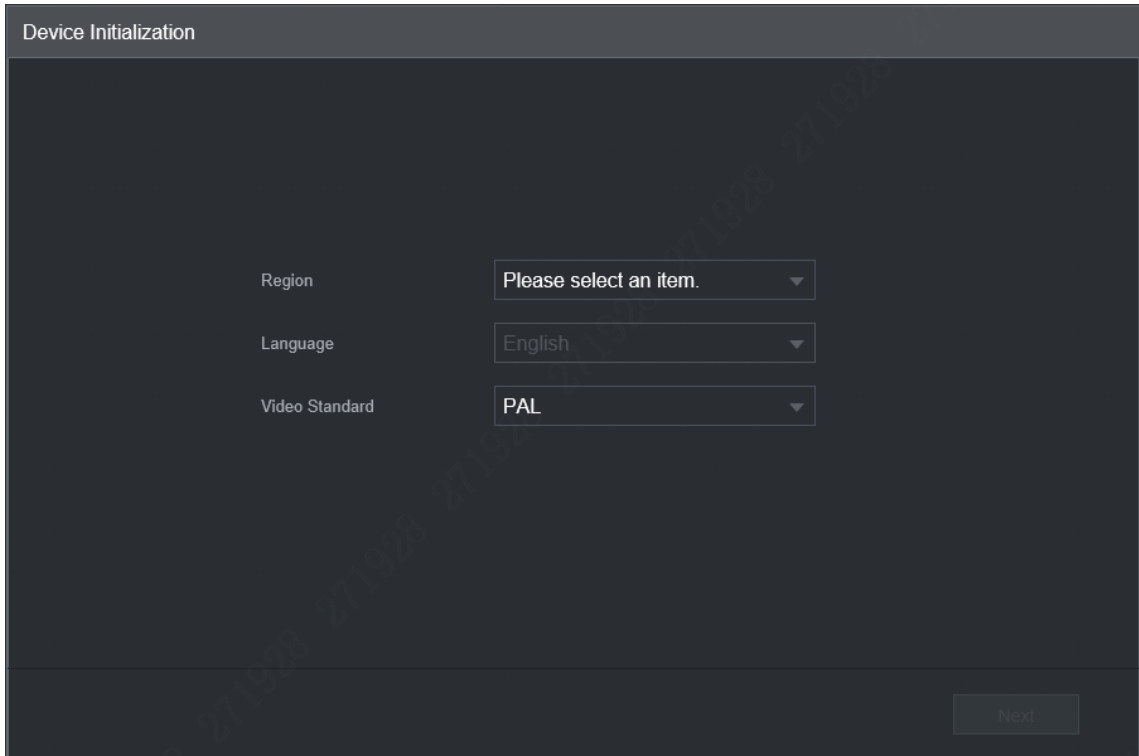

Device Initialization

Region  ▼

Language  ▼

Video Standard  ▼

Next

**Step 2** Set the **Region**, and click **Next**.

The **Password Setting** interface is displayed. See Figure 3-2.

Figure 3-2 Password setting

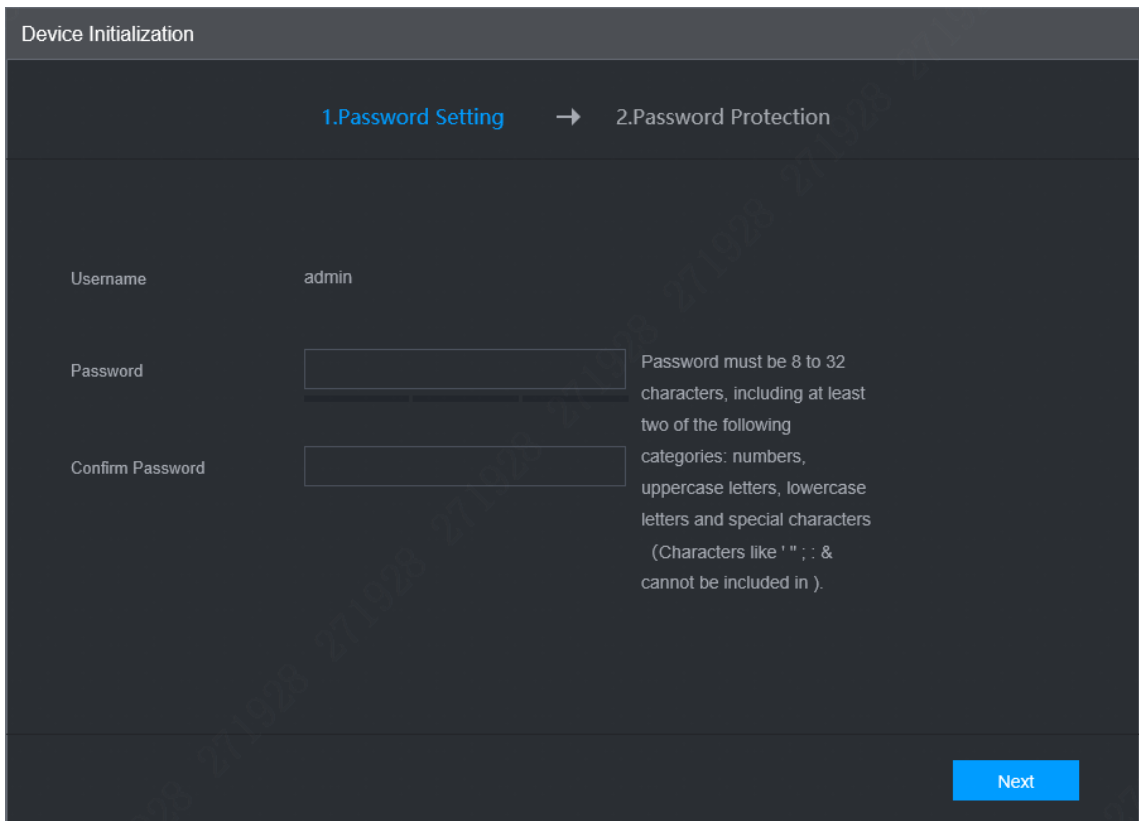

Device Initialization

1.Password Setting → 2.Password Protection

Username

Password

Confirm Password

Password must be 8 to 32 characters, including at least two of the following categories: numbers, uppercase letters, lowercase letters and special characters (Characters like " " ; : & cannot be included in ).

Next

**Step 3** Enter the **Password** and enter it again in the **Confirm Password** box. Click **Next**.

The **Password Protection** interface is displayed. See Figure 3-3.

Figure 3-3 Password protection

Device Initialization

1.Password Setting → 2.Password Protection

Reserved Email

For password reset. Recommended or improved in time.

Security Question

Question 1

Answer

Question 2

Answer

Question 3

Answer

OK

**Step 4** Select the reset type based on your needs. It is recommended to enable the two types as follows.

- Select **Reserved Email** and then enter email address.
- Check the **Security Question** box, select the question and enter the corresponding answer.

**Step 5** Click **OK**.

Device initialization completed.

### 3.3 Logging in to Device

You can log in to and then configure the device.

**Step 1** Open the browser, enter the Device IP address, and then press **Enter**.

The **WEB Login** interface is displayed. See Figure 3-4.

Figure 3-4 WEB Login

Web Login

[Forgot password?](#)

Login



**Step 2** Enter user name and password, and then click **Login**.



For **admin** account, if you forget password, click **Forgot password?** to find back the password. For details, see "5.8.3 Resetting Password".

Figure 3-5 WEB interface

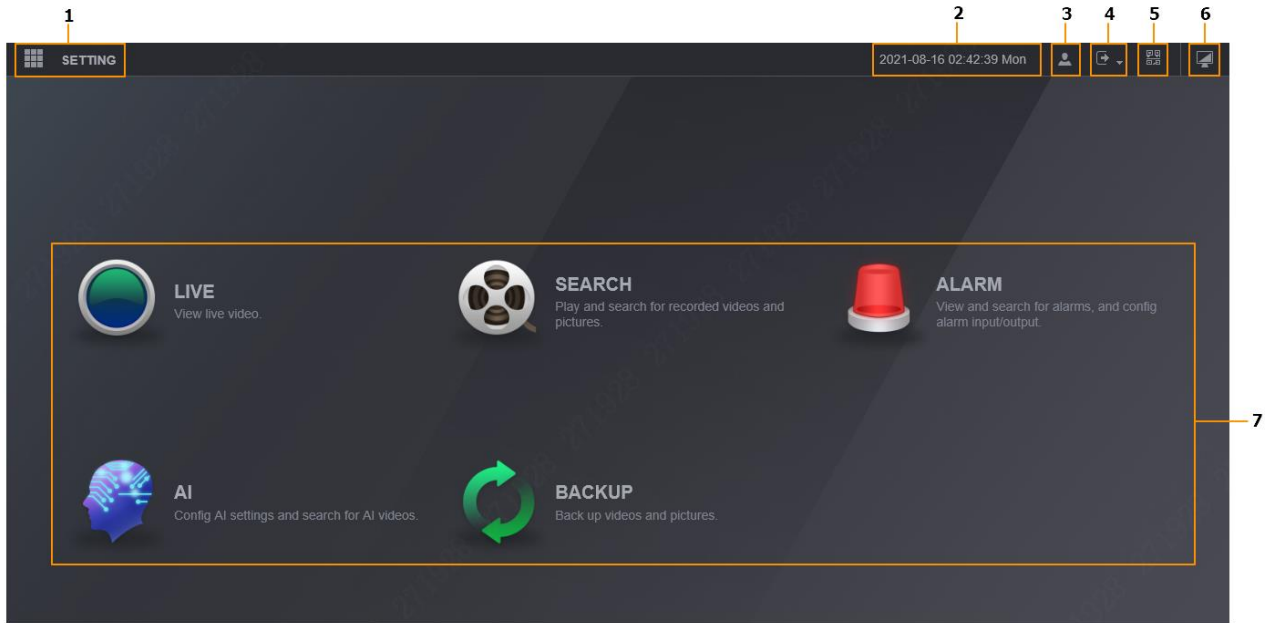

Table 3-1 Description of WEB interface

No.	Name	Description
1	Setting	Click  or <b>Setting</b> . See Figure 3-6.
2	Time	Display the current time.
3	User	Display the user that currently logs in.
4	Logout	Click , the system displays as Figure 3-7. Select <b>Logout</b> or <b>Restart</b> as needed.
5	QR Code	Click , the system displays as Figure 3-8. Scan device serial number to add the device to APP.
6	Desktop	Click  to return to WEB main interface.
7	Operation	System operation

Figure 3-6 Setting

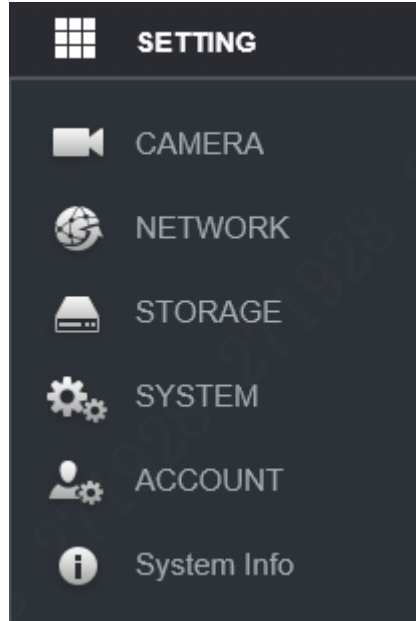

Figure 3-7 Logout

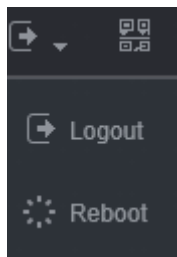

Figure 3-8 QR Code



### 3.4 Configuring IP Address

Connect the device to the network and make sure the device can communicate with other devices in the network diagram.

## Prerequisites

Make sure the device is connected to the network properly.

## Procedure

**Step 1** Select **Setting > Network > TCP/IP**.

The **TCP/IP** interface is displayed, see Figure 3-9.

Figure 3-9 TCP/IP

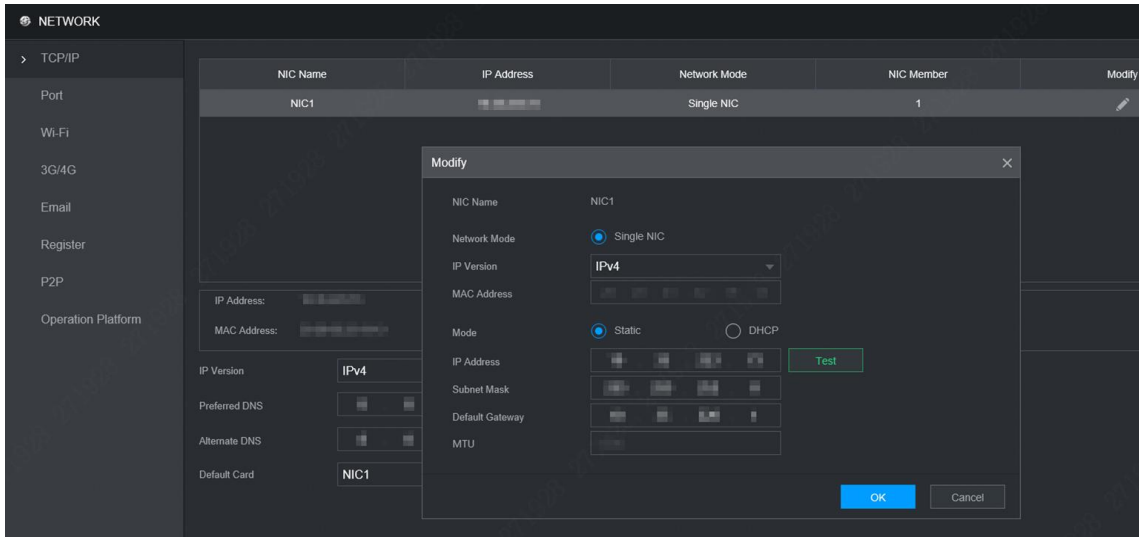

**Step 2** Click **Modify**. The **Modify** interface is displayed. See Figure 3-10.

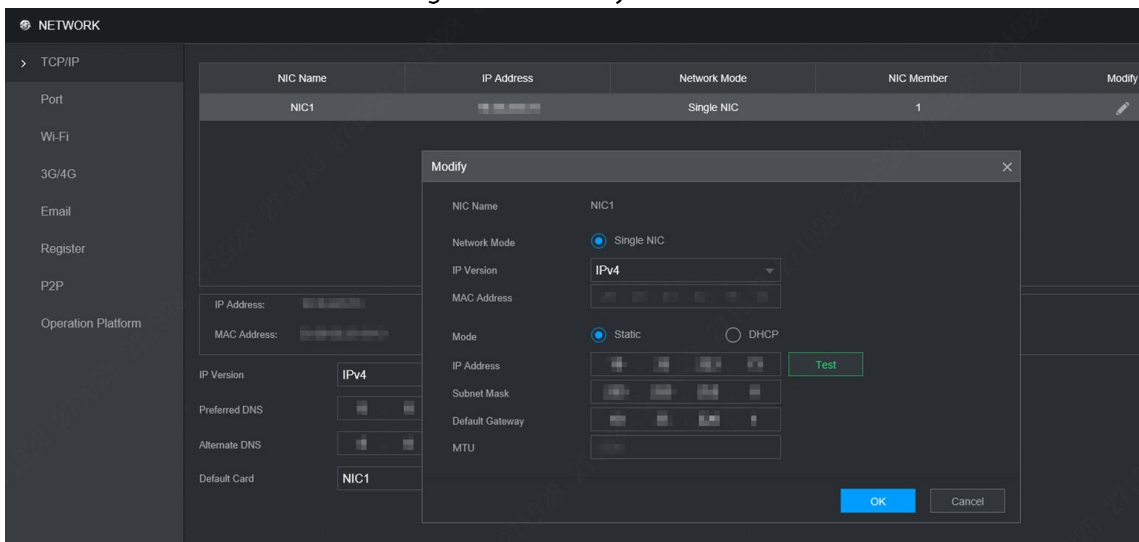

Figure 3-10 Modify



**Step 3** Configure parameters. For details, see Table 3-2.

Table 3-2 TCP/IP parameters description

Parameter	Description
IP Version	Select <b>IPv4</b> or <b>IPv6</b> . Both versions are supported.  For IPv6 version, in the <b>IP address</b> box, <b>Gateway</b> box, <b>Preferred DNS</b> box, and <b>Alternate DNS</b> box. Please enter 128 bits and it cannot be blank.
MAC Address	MAC address of the host, which cannot be modified.

Parameter	Description
DHCP	The system automatically obtains an IP address. When the <b>DHCP</b> function is enabled, the <b>IP address</b> , <b>Gateway</b> , and <b>Subnet mask</b> cannot be set manually.  No matter the DHCP function is enabled or not, you can view the current IP address.
IP Address	According to your network plan, enter the modified IP address, gateway and subnet mask.  Please ensure IP address and subnet mask are in the same network segment, which means the front parts of the IP address and of the default gateway are the same one.
Subnet Mask	
Default Gateway	
Preferred DNS	IP address of DNS server.
Alternate DNS	Alternate IP address of DNS.

Step 4 Click **OK**.

## 3.5 Configuring General Setting

You can configure the basic settings, including basic and Date&Time.

### 3.5.1 Basic

Set up the general information of the device, including language, video standard, menu standby duration, license plate, and more.

Step 1 Select **Setting > System > General > Basic**.

The **Basic** interface is displayed. See Figure 3-3.

Table 3-3 Basic

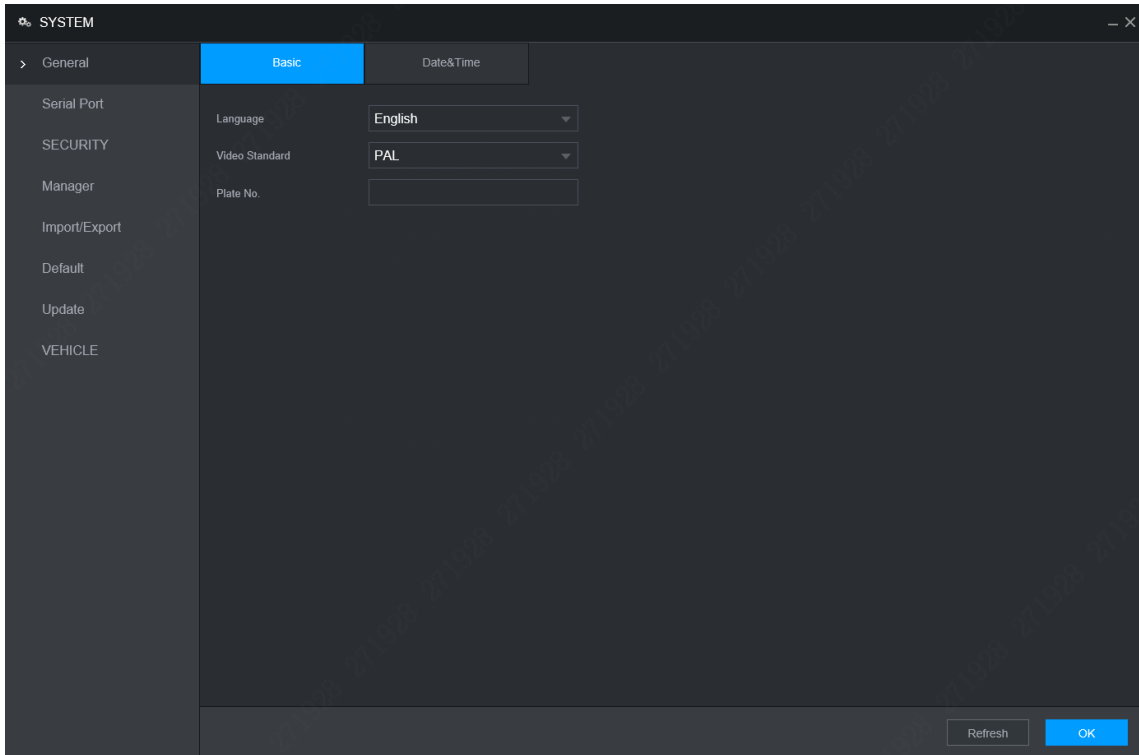

**Step 2** Configure parameters. For details, see Table 3-4.

Table 3-4 General settings parameters description

Parameter	Description
Language	Select a language for the system.
Video Standard	Displays the video encode standard.
Plate No	Enter the plate number of vehicle where the device is located.

**Step 3** Click **OK**.

### 3.5.2 Date&Time

You can configure settings such as date format, time format, and timing mode.

**Step 1** Select **Setting>System > General > Date&Time**.

The **Date&Time** interface is displayed. See Figure 3-11.

Figure 3-11 Date&amp;Time

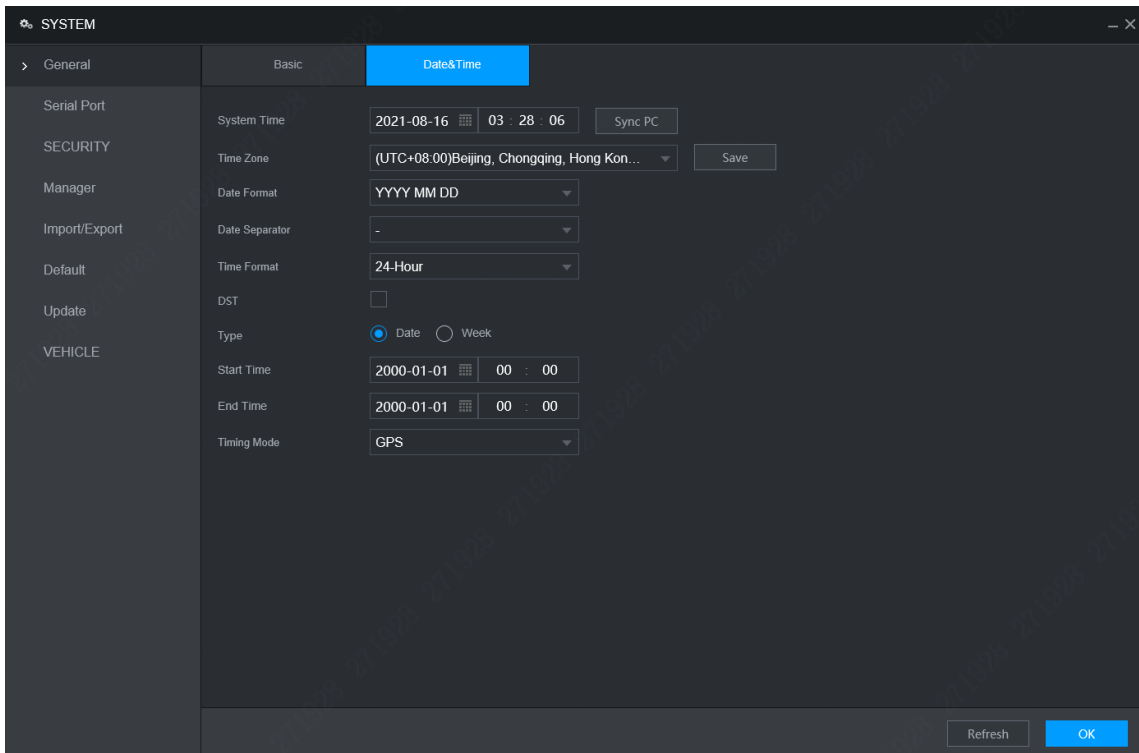

**Step 2** Configure parameters. For details, see Table 3-5.

Table 3-5 Date&amp;Time parameters description

Parameter	Description
System Time	Displays the current system date and time.
Time Zone	The time zone where the device locates. In the <b>Timing Mode</b> list, if <b>GPS</b> or <b>NTP</b> is selected, configure this parameter.
Date Format	Set the date display format of the device, including YYYY-MM-DD, MM-DD-YYYY and DD-MM-YYYY.
Date Separator	Separator style of date.
Time Format	Select a time format, including 24-hour and 12-hour.
DST	The DST is applied in some countries or regions. Select the DST check box if it is applied where the device is located
DST Type	
Start Time	1. Select the <b>DST</b> check box. 2. According to the local regulations, configure the type, start time and end time for the DST.
End Time	
Timing Mode	Select a timing mode, including DSS, GPS, and NTP. The default selection is NTP. <ul style="list-style-type: none"> <li>● <b>DSS</b>: The system time syncs with DSS platform.</li> <li>● <b>GPS</b>: The system time syncs with satellite.</li> <li>● <b>NTP</b>: The system time syncs with NTP server that you configured.</li> </ul>
Server Address	In the <b>Timing Mode</b> list, if <b>NTP</b> is selected, configure this parameter. After configuring NTP server, the device syncs time with NTP server.
Port	

Parameter	Description
Interval	<ol style="list-style-type: none"> <li>In the <b>Timing Mode</b> list, select <b>NTP</b> to enable the NTP timing function.</li> <li>Configure parameters.                             <ul style="list-style-type: none"> <li>◇ Server: Enter IP address of NTP server.</li> <li>◇ Synchronize: Click <b>Manual Update</b> to sync the device time with NTP server.</li> <li>◇ Port: The system supports TCP protocol only and the default setting is 123.</li> <li>◇ Interval: Enter the interval that you want the device to sync time with the NTP server. The maximum value is 65535 minutes.</li> </ul> </li> </ol>

Step 3 Click **OK**.

## 3.6 Configuring Record Mode

The record mode is consisted of manual mode and auto mode. You can also enable or disable the snapshot function.

- Auto: The recording starts automatically according to the record type and recording time as configured in the recording schedule.
- Manual: Keep general recording for 24 hours for the selected channel.



Manual recording operation requires the user have the permission to access **Storage Settings**.

Check to ensure the HDD installed in the device has been formatted properly.

Step 1 Select **Setting** > **Storage** > **Record Mode**.

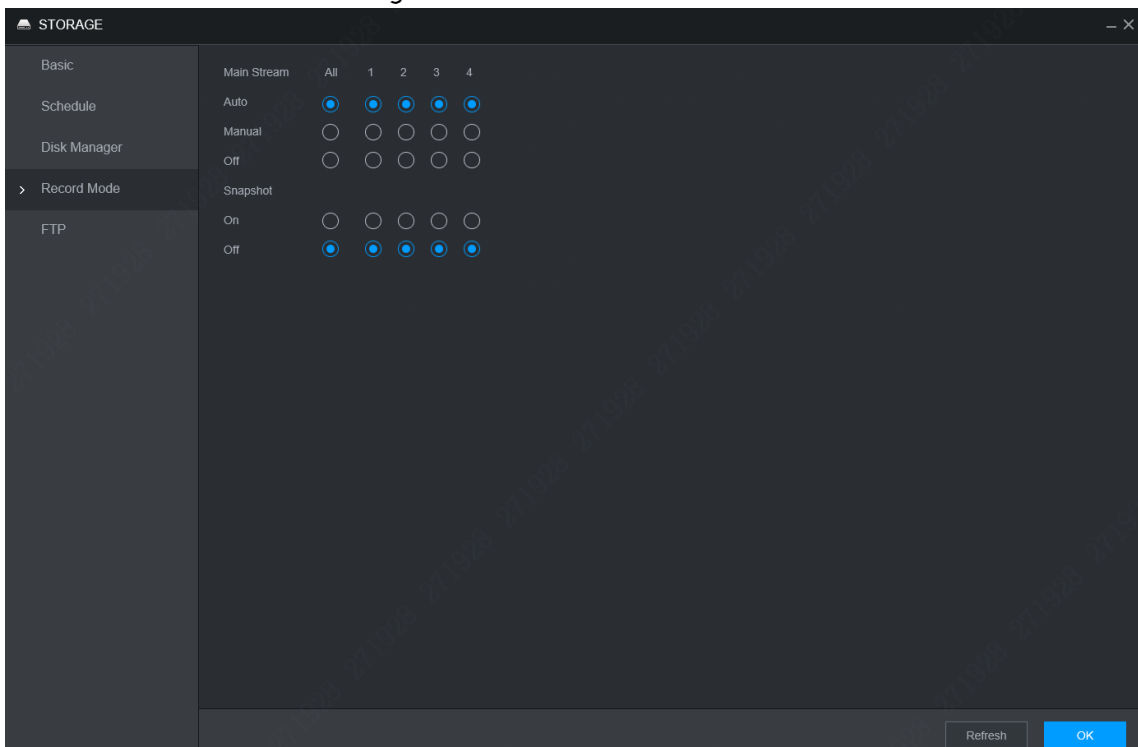

The **Record Mode** interface is displayed, see Figure 3-12.

Figure 3-12 Record mode



**Step 2** Configure parameters. For details, see Table 3-6.

Table 3-6 Record control parameters description

Parameter	Description
Channel	Displays the channel number. You can select one or several channels or select <b>All</b> .
Status	Indicates the recording status of corresponding channels. The choices include Auto, Manual, Enable, and Close. <ul style="list-style-type: none"> <li>● : Selected.</li> <li>● : Not selected.</li> </ul>
Auto/Manual/Off	Select the recording mode, including Manual, Auto, and Stop <ul style="list-style-type: none"> <li>● Manual: Top priority. When the <b>Manual</b> check box is selected, the system keeps general recording for 24 hours for the corresponding channel.</li> <li>● Auto: The system starts recording according to the record type (such as general alarm, motion detect, and system alarm) and recording time.</li> <li>● Stop: Do not record.</li> </ul>
On/Off	Enable or disable the scheduled snapshot for the corresponding channels.

**Step 3** Click **OK**.

## 3.7 Configuring Storage Plan

### 3.7.1 Record Schedule

The default recording setting is 24 hours recording for all channels. You can configure the record type and recording time according to your actual situation.

#### Prerequisites

The auto recording is enabled for the corresponding channel. For details, see "3.6 Configuring Record".

#### Procedure

**Step 1** Select **Setting > Storage > Schedule > Record**.  
**Record** interface is displayed. See Figure 3-13.



Figure 3-13 Record

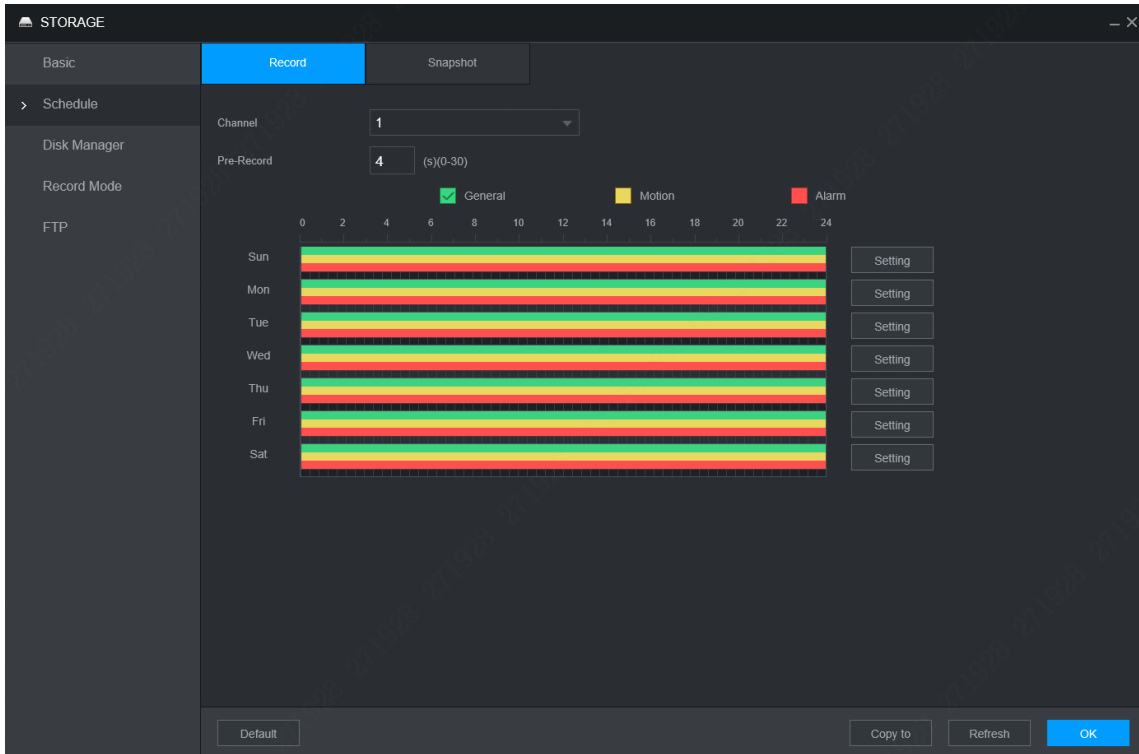

**Step 2** Configure parameters. For details, see Table 3-7.

Table 3-7 Record schedule parameters description

Parameter	Description
Channel	Select a channel to configure the corresponding recording schedule. If you configure the same setting for all channels, select <b>All</b> .
Pre-record	Start recording for 0 seconds to 30 seconds before the alarm event occurs. If you enter 0 seconds, there will be no pre-recording.

**Step 3** Set periods of the record by drawing or editing.

- Drafting method
  1. Select the type of recordings by selecting the check box in front of the type. See Figure 3-14.

Figure 3-14 Record type

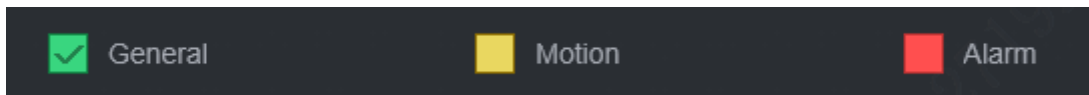

2. Press and hold the left button and drag the mouse in the period illustration to draft the period.  
 There are six periods in one day. The device activates recordings of the preset type in each preset period. In the period illustration displayed in the figure, the color bar shows the **Recording Type** corresponding to the period.
  - ◇ Green means general recordings are effective.
  - ◇ Yellow means motion recordings are effective.
  - ◇ Red means alarm recordings are effective.

Figure 3-15 Draw

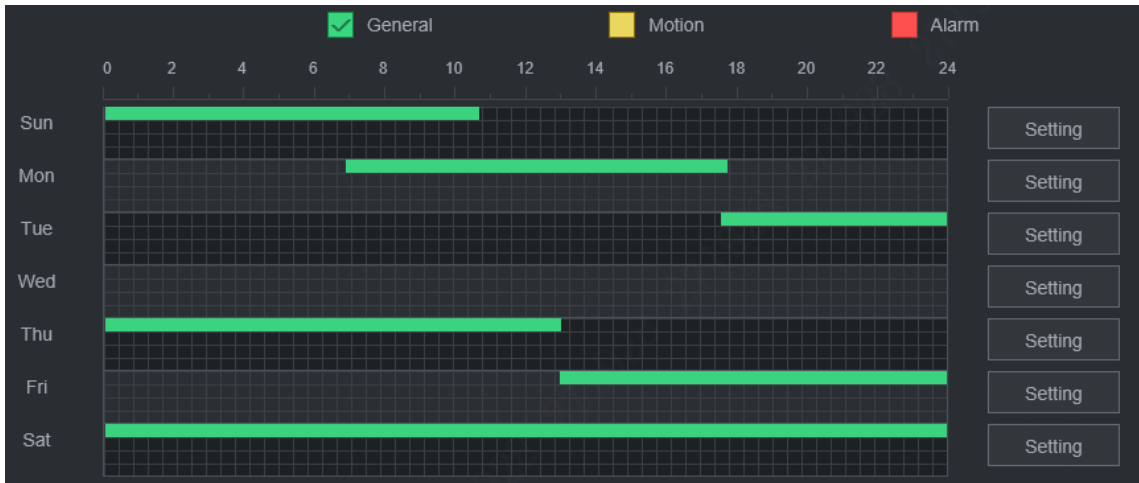

- Editing Method
  1. Click **Setting** corresponding to the week.  
The **Setting** interface is displayed. See Figure 3-16.

Figure 3-16 Setting

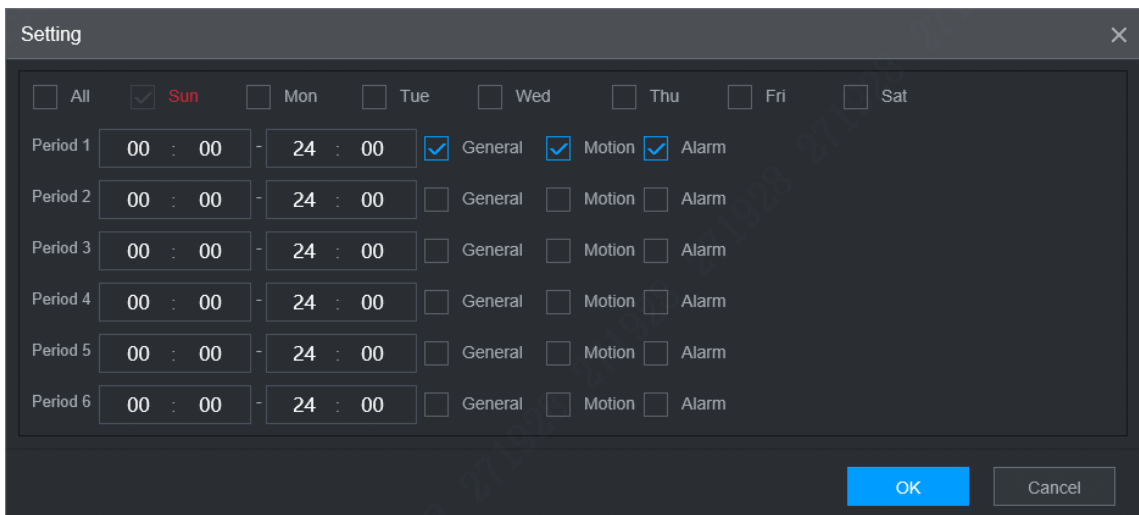

2. Select the record type and weekday, and enter the recording period.
3. Click **OK**.  
The recording schedule appears on the **Recording Plan** interface to view the configured recording schedule directly.

Step 4 Click **OK**.



- Click **Copy to** and you can copy the settings to other channels.
- Click **Default**, and the device is restored to default configuration.

## 3.7.2 Snapshot Schedule

You can configure the storage schedule for taking the snapshot.

## Prerequisites

The snapshot is enabled for the corresponding channel. For details, see "3.6 Configuring Record".

## Procedure

**Step 1** Select **Setting > Storage > Schedule > Snapshot**.

The **Snapshot** interface is displayed. See Figure 3-17.

Figure 3-17 Snapshot

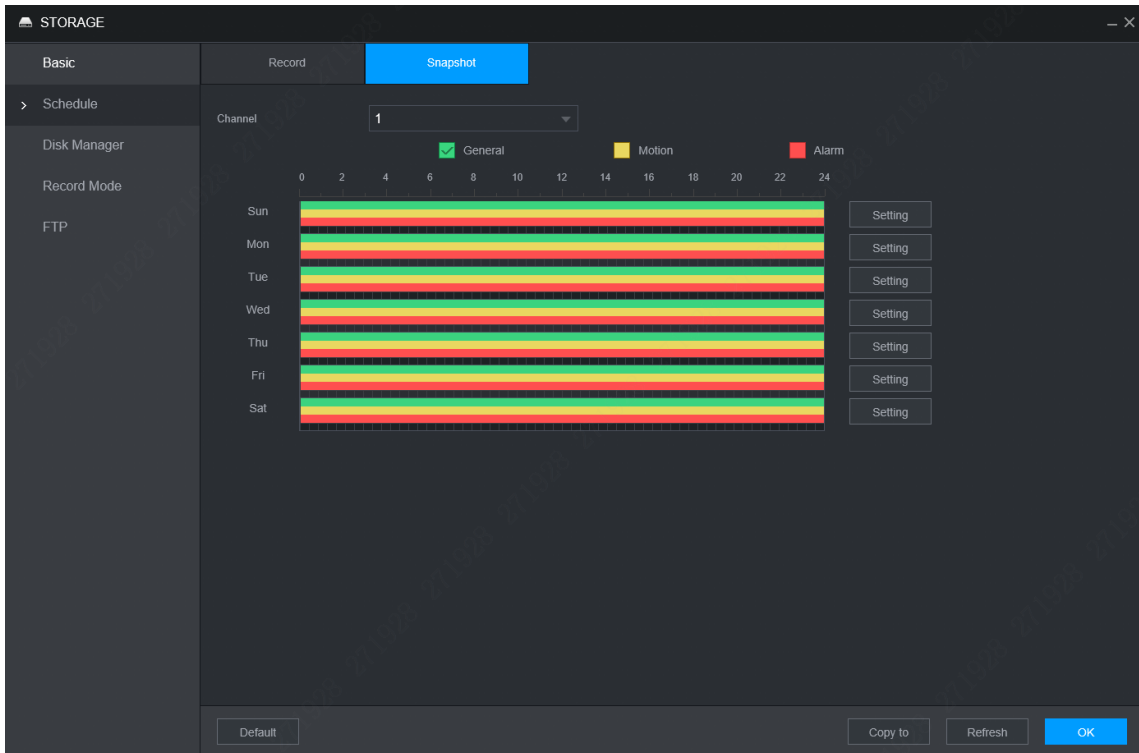

**Step 2** Set snapshot period by drafting and editing.

- Drafting method
  1. Select the type of snapshot by selecting the check box in front of the type. See Figure 3-18.

Figure 3-18 Snapshot Type

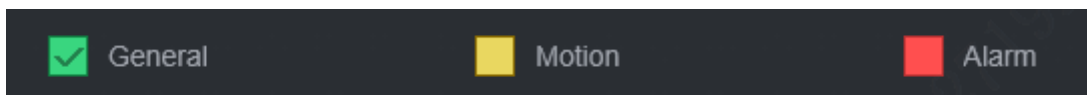

2. Press and hold the left button and drag the mouse in the period illustration to draft the period.

You can set six periods in one day. The device activates the snapshot method of the preset type in each preset period. In the period illustration displayed in the figure, the color bar shows the **Snapshot Type** corresponding to the period.

- ◇ Green means general snapshots are effective.
- ◇ Yellow means motion detection snapshot are effective.
- ◇ Red means alarm snapshots are effective.

Figure 3-19 Draw

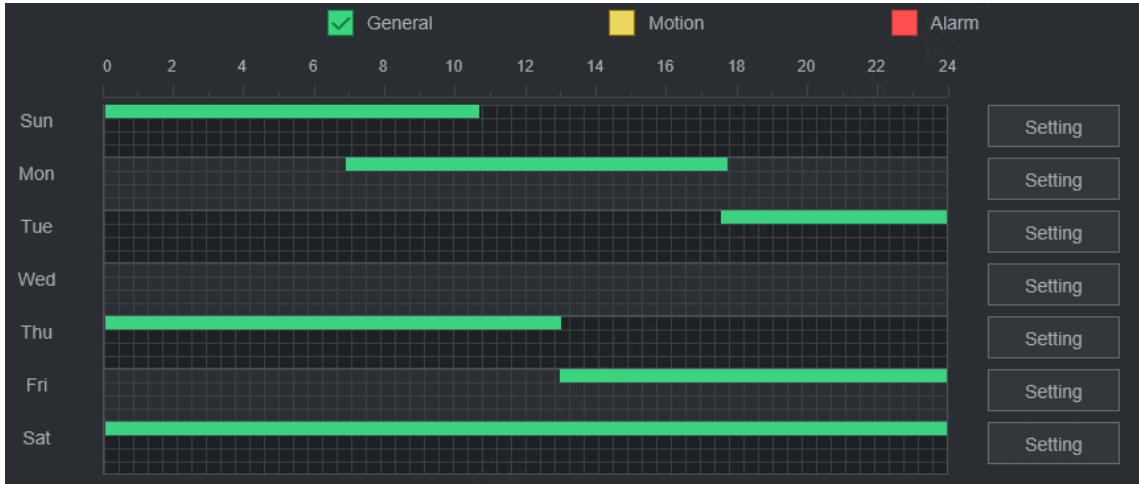

- Editing Method
  1. Click **Setting**.  
The **Setting** interface is displayed. See Figure 3-20.

Figure 3-20 Period

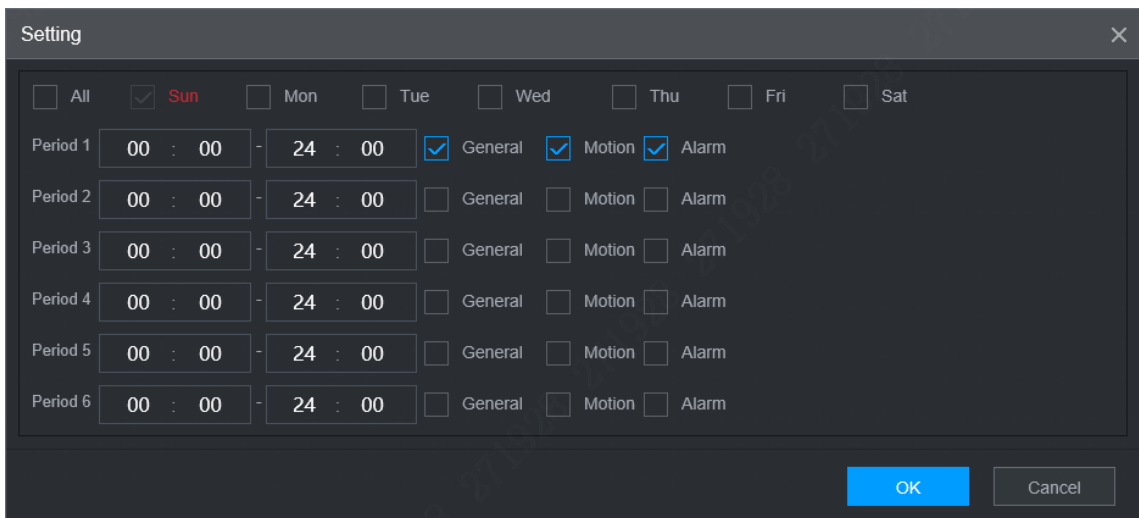

2. Select the snapshot type and weekday, and enter the period for taking snapshot.
3. Click **OK**.  
Snapshot schedule appears on the **Snapshot** interface to view the configured snapshot schedule directly.

Step 3 Click **OK**.



- Click **Copy to** and you can copy the settings to other channels.
- Click **Default**, and the device is restored to default configuration.

# 4 Function Operations

## 4.1 Live

Log in and click **Live**, the **Live** interface is displayed. See Figure 4-1.

Figure 4-1 Live

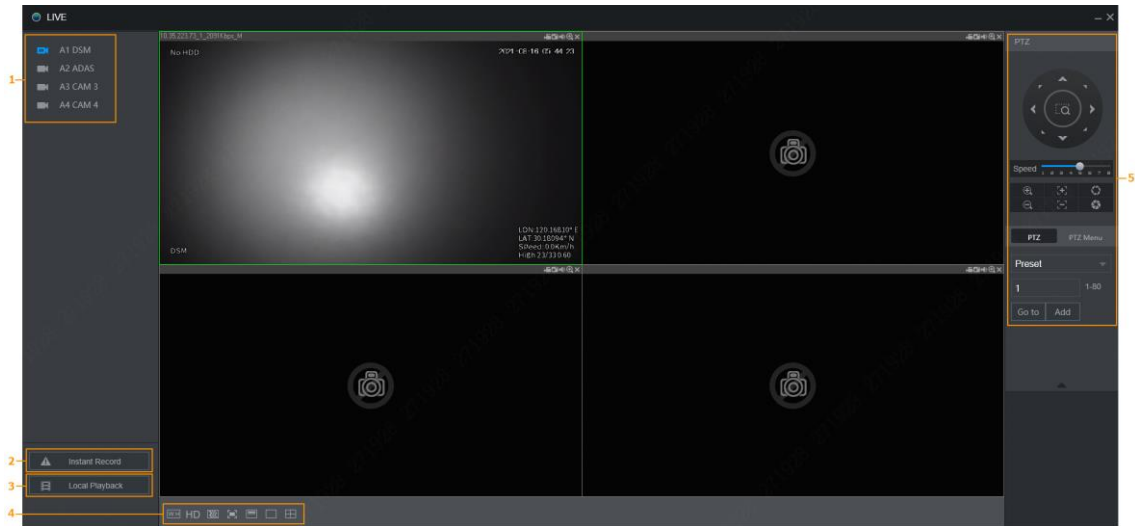





Table 4-1 Live interface parameters description

No.	Name	Description
1	Real-time Monitoring Channels	See "4.1.1Real-time Monitoring Channels".
2	Instant Record	Click <b>Instant Record</b> and the recording type switches to Manual, and the icon turns to  ; click <b>Instant Record</b> again to switch the record type back to Auto.  This function is only supported by main stream.
3	Local Playback	Plays back the video file (.dav) stored on the PC. Click <b>Local Playback</b> , select the video file in the pop-up dialog box, and then click <b>Open</b> to start playing back the video file
4	Window Function Operations	Configure the scale, image quality, playback fluency, full screen, and window split mode. For real-time monitoring, you can select the fluency or real-time to be the priority according to your actual requirement. Select  to split the preview window as necessary.

## 4.1.1 Real-time Monitoring Channels

Displays the list of monitoring channels.

Figure 4-2 Monitoring channels

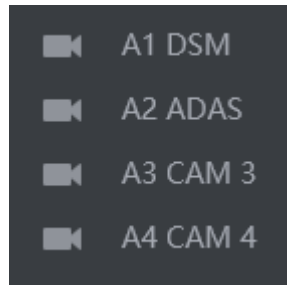

### Operations in monitoring channels

Click any monitoring channel to display its live video on the screen. See Figure 4-3.

Figure 4-3 Video monitoring screen

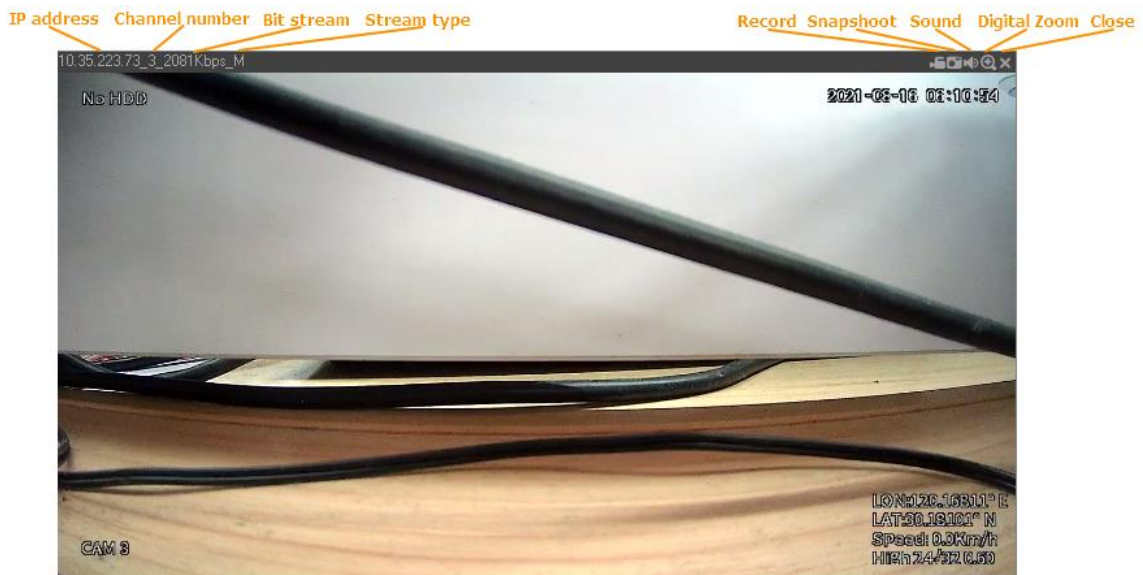



Table 4-2 Video monitoring window parameters description

Parameter	Description
Device Information	Displays the IP address, channel number, bit stream, and stream type (M represents main stream, S represents sub stream)
Record	Click this icon to start recording; click it again to stop recording.  The recorded files default storage path is C:\RecordDownload. You can modify this path if needed. For details, see "5.4.2.4 Storage Path".
Snapshot	Click this icon to start taking snapshot.  The snapshots default storage path is C:\PictureDownload. You can modify this path if needed. For details, see "5.4.2.4 Storage Path".
Sound	Turns on/off audio. If audio function is not enabled in the encode settings, the monitoring does not give sound.

Parameter	Description
Digital Zoom	Click this icon and then hold down the left mouse button to select the area you want to enlarge. The area is enlarged. Click this icon again or right-click on the window to exit.
Close	Close the live view in the window.

## Stream Type

The system supports switching between main stream and sub stream in real-time monitoring window. See Figure 4-4. For details about stream settings, see “5.4.2 Encode Parameters”.

Figure 4-4 Stream type

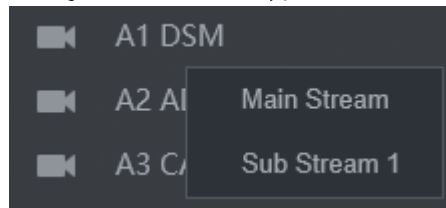

## 4.2 Video Playback

On the **Search** interface, you can play back or download video recording files.

On the main WEB interface, click **Search**, and the **Search** interface is displayed. See Figure 4-5.

Figure 4-5 Search

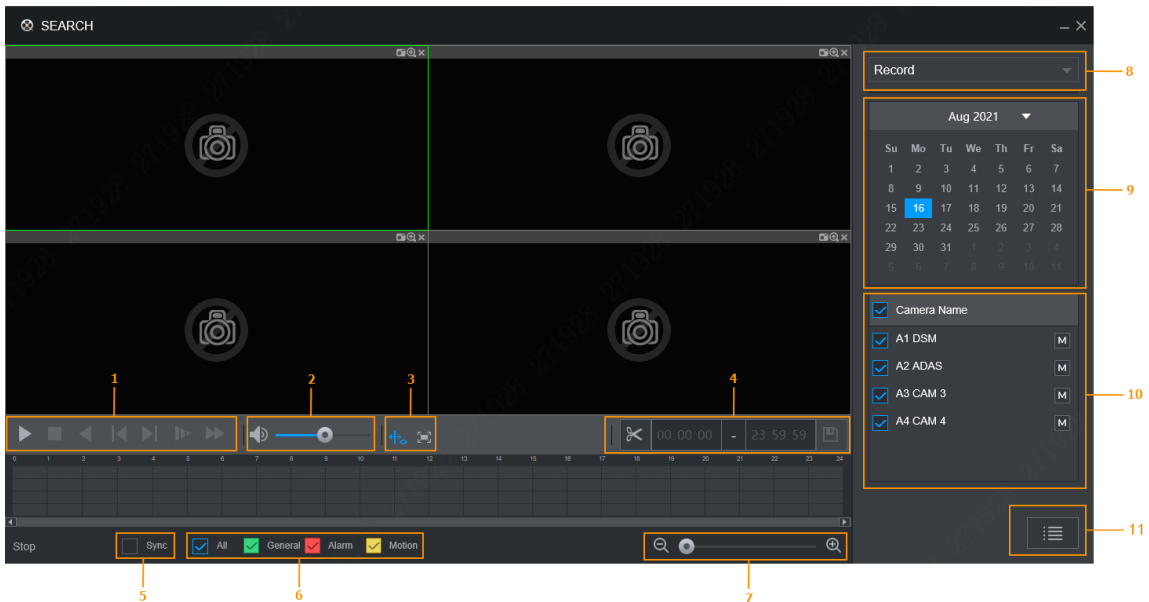







Table 4-3 Function bar description



No.	Function	Description
1	Control Bar	For detailed information about control buttons, see “4.2.2 Control Bar”.

No.	Function	Description
2	Volume Bar	Controls playback volume, including: <ul style="list-style-type: none"> <li> means mute mode.</li> <li> means normal playing and the volume can be adjusted.</li> </ul>
3	Full Screen Button	To play the video recording in full screen.
4	Video Clip	Clip a section of recorded video and save it. See "4.2.4 Clipping Recording File".
5	Sync	With <b>Sync</b> selected, when you click in the progress bar to play back the recordings, the playback time of other channels will sync with the selected channel in the following ways: <ul style="list-style-type: none"> <li>If the playback time of other channels is before the time of the selected channel, other channels will speed up the playback till synced with the selected channel.</li> <li>If the playback time of other channels is after the time of the selected channel, other channels will pause to wait till synced with the selected channel.</li> </ul>
6	Record Type	The record types include General, Alarm, and Motion. You can select the type as needed.
7	Time Bar	Move the slider or click  /  to adjust the time bar.
8	Playback Type	To select the playback type. Only record playback is supported at present.
9	Calendar	Click the date on which you want to play back the recorded video.
10	Channel List	You can set the cameras to focus on.  You can select up to 4 cameras.
11	File List	You can download recorded video by file type or time, and verify the completeness.

## 4.2.2 Control Bar

Playback control buttons. For details, see Table 4-4.

Table 4-4 Playback controls bar introduction

Icon	Function	Description
	Play	When this icon displays, it means the video is paused or not being played. You can click this icon to play the video.
	Stop	Click this icon to stop playing.
	Play Backward	Click this icon to play the video recording backward.



Icon	Function	Description
	Previous Frame	Click this icon to jump to the previous frame.  You need to pause the playback before playing the next frame.
	Next Frame	Click this icon to jump to the next frame.  You need to click the <b>Stop</b> icon before playing the next frame.
	Slow	Click this icon to adjust the slow playback speed. Click  to start slow playback.
	Fast	Click this icon to adjust the fast playback speed. Click  to start fast playback.

## 4.2.3 Playing Back Recorded Video Files

You can play back video recordings by time or file name. During playback, you can conduct the following operations.

- In the channel window, click at the upper right corner and select the area you want to enlarge. The area is enlarged. Click this icon again or right-click in the window to exit.
- Click at the upper right corner to take a snapshot.
- Click at the upper right corner to close playback..

### 4.2.3.1 Playing Back Video Recordings by Date

Step 1 Select the date for searching for the video recordings, and set the corresponding channel as needed.

Step 2 Select a date with recorded video files, click on the window channel to select a playback channel, and then select the record type.

Figure 4-6 Record type

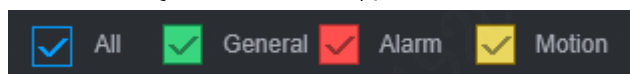

Step 3 Click to start playing back recorded video.

### 4.2.3.2 Playing Back Video Recordings by File Name

Step 1 Select the date for searching for the video recordings, and set the corresponding channel as needed.

Step 2 Select a date with recorded video files, click on the window channel to select a playback channel.

Step 3 Click File List.

The video recordings are displayed in the list. See Figure 4-7.

Figure 4-7 File List

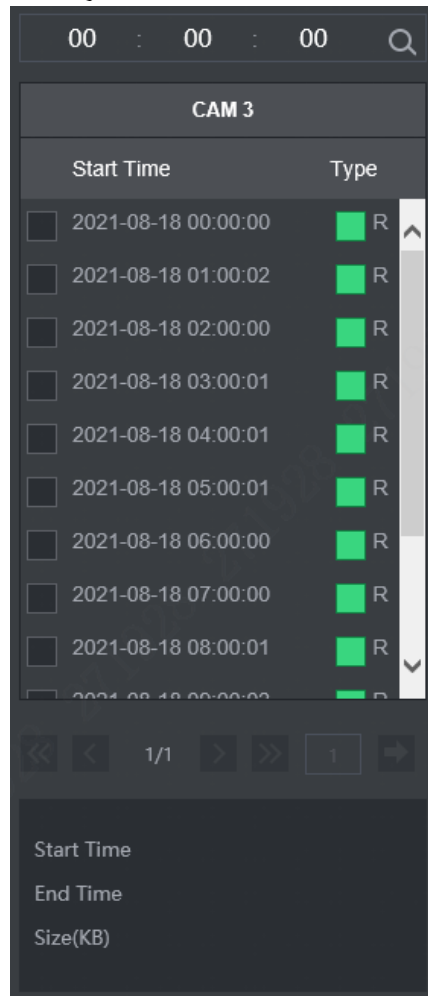

**Step 4** Set the start time of the file to be searched for, and then click . The recording files are displayed.

**Step 5** Double-click the video recordings to start playback.

## 4.2.4 Clipping Recording File

Clip a section recorded video file you do of 0 recorded video, and save it to PC.

**Step 1** On the **Search** interface, select **Mode**, **Date**, and **Record Type** for concentration playback. The corresponding search result is displayed.

**Step 2** Select a playback window, and then tap.

**Step 3** Capture the video segment you need through the following methods:

- Enter the start time and end time you need to edit in .
- Click and video clipping frame appears on the time bar. See Figure 4-8. Press the record edit column (the white column on) and drag to the left or right, to select start time and end time of clipping.

Figure 4-8 Video clipping frame

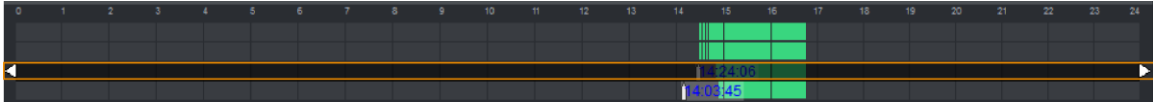

**Step 4** Click  to select save path.

**Step 5** Click **OK**.  
The system begins to save the record file and displays the saving progress.



Click  to stop downloading the recordings.

## 4.3 Alarm Info

You can view the alarm information during a fixed period.

**Step 1** On the main WEB interface, click **Alarm > Alarm Info**.

The **Alarm Info** interface is displayed. See Figure 4-9.

Figure 4-9 Alarm info (1)

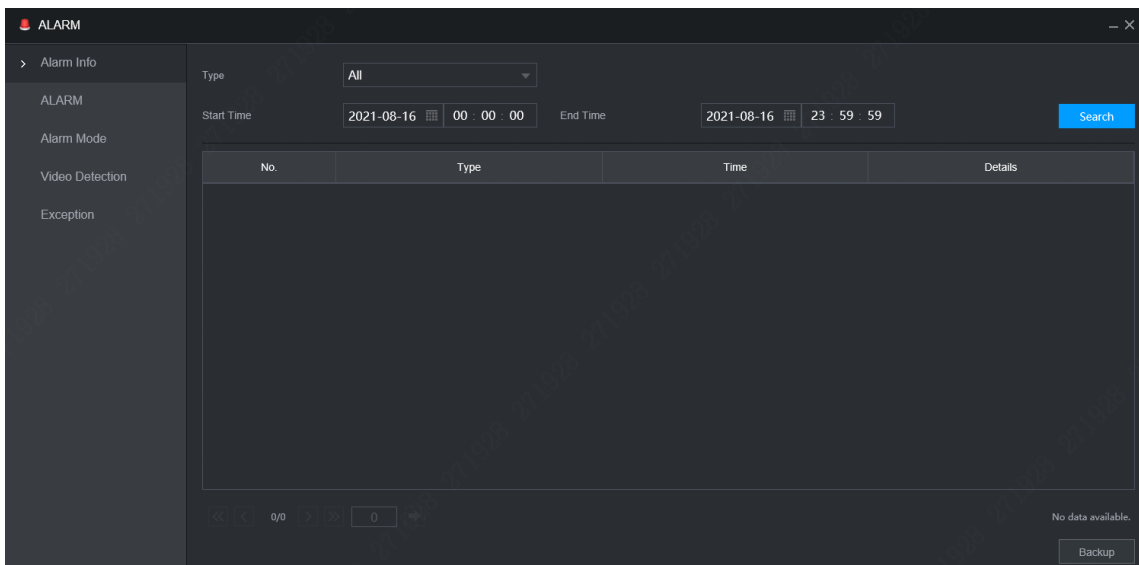

**Step 2** Select **Type** to set the alarm type to be searched for, including **All, Motion Detection, Video Loss, Tampering, Exception, Local Alarm** and **Intelligent**.









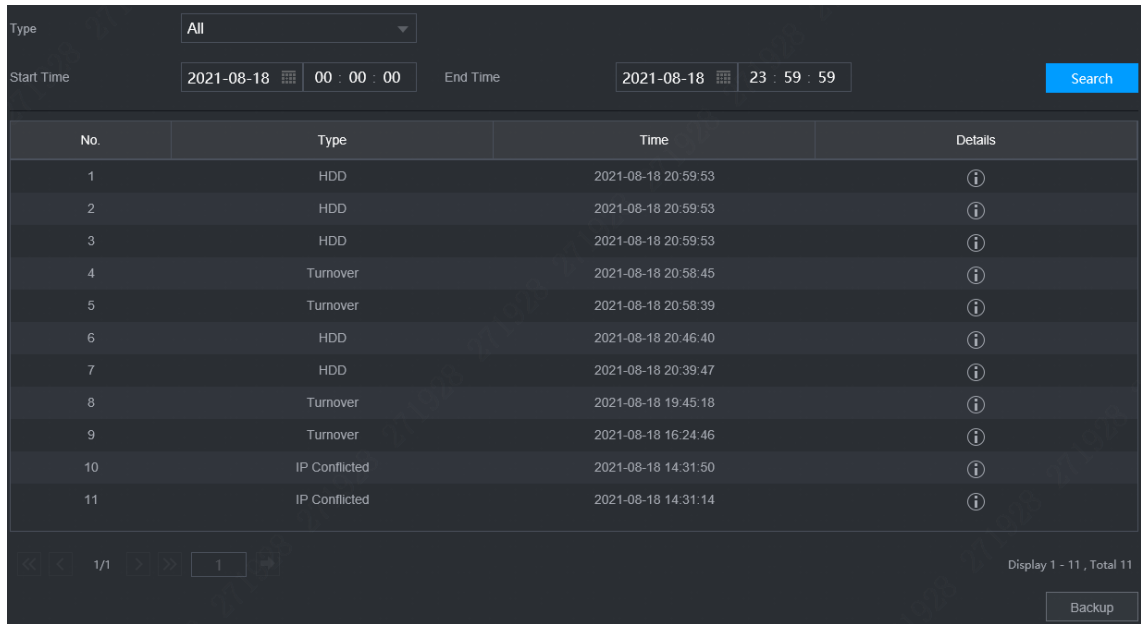

**Step 3** Enter the start time and end time.

**Step 4** Click **Search**.

Alarm information in the set type during the set period is displayed. See Figure 4-10.

Figure 4-10 Alarm info (2)



No.	Type	Time	Details
1	HDD	2021-08-18 20:59:53	
2	HDD	2021-08-18 20:59:53	
3	HDD	2021-08-18 20:59:53	
4	Turnover	2021-08-18 20:58:45	
5	Turnover	2021-08-18 20:58:39	
6	HDD	2021-08-18 20:46:40	
7	HDD	2021-08-18 20:39:47	
8	Turnover	2021-08-18 19:45:18	
9	Turnover	2021-08-18 16:24:46	
10	IP Conflicted	2021-08-18 14:31:50	
11	IP Conflicted	2021-08-18 14:31:14	

**Step 5** Click **Backup** to back up the obtained alarm information to a local directory.



You need to install relevant controls before backup.

## 5 System Settings

You can set up system information following instructions on the Local interface or WEB interface. This section introduces the WEB interface instructions. The Local interface is similar and would not be elaborated here.



- Some functions can only be configured on the Local interface. The actual interface shall prevail.
- Some functions are not used in actual operations, so they are not described in detail in the document.
- In this section, when you have configured the settings for a channel, click **Copy** to apply the settings to other channels. Click **Refresh** to display the latest configuration. Click **Default** to restore to factory default settings.

### 5.1 Configuring Alarm Events

Alarm settings include the setting of video detection, alarm, exception and alarm mode.

#### 5.1.1 Video Detection

Video detection includes motion detect, video loss, and video tampering. This function detects the abnormal changes and triggers alarms.

##### 5.1.1.1 Video Motion

When the moving object appears and moves fast enough to achieve the preset sensitivity value, the system triggers an alarm and alarm linkage.

Step 1 On the main WEB interface, select **Alarm > Video Detection > Motion Detect**.

The **Motion Detect** interface is displayed. See Figure 5-1.

Figure 5-1 Motion Detect

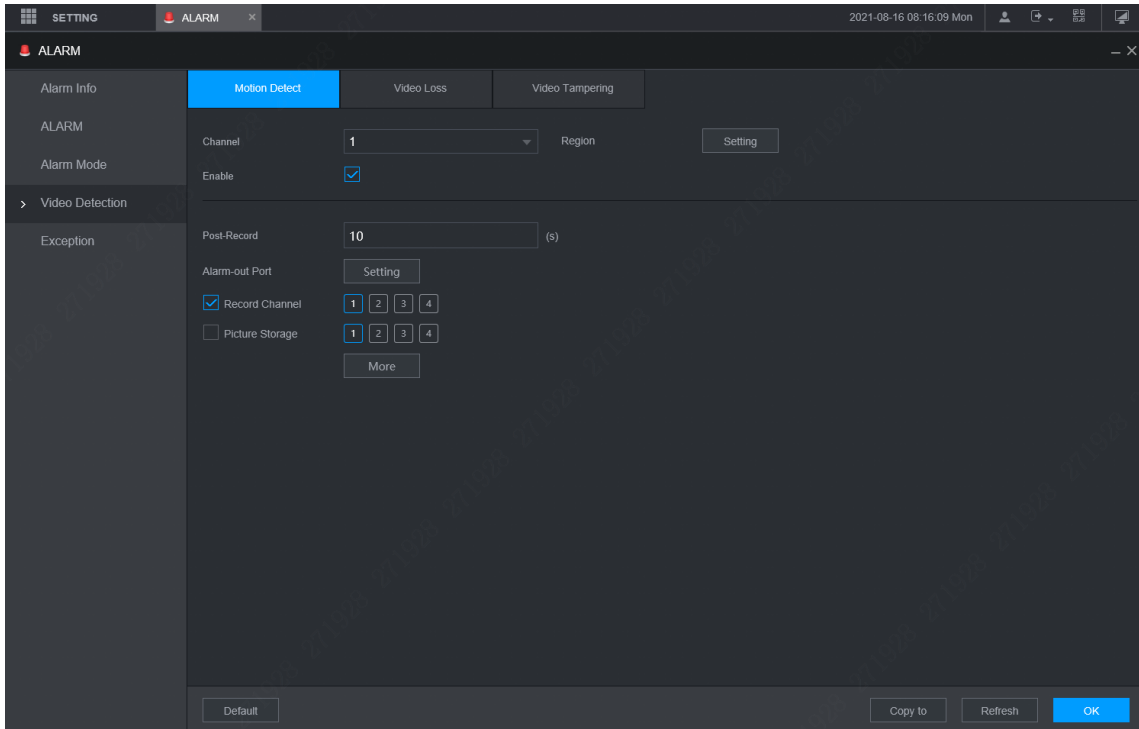

**Step 2** Select the channel number and select **Enable** to enable the motion detect for the channel.

**Step 3** Set motion detect region.

- 1) Next to **Region**, click **Setting**.

The **Setting** interface is displayed. See Figure 5-2.

Figure 5-2 Setting

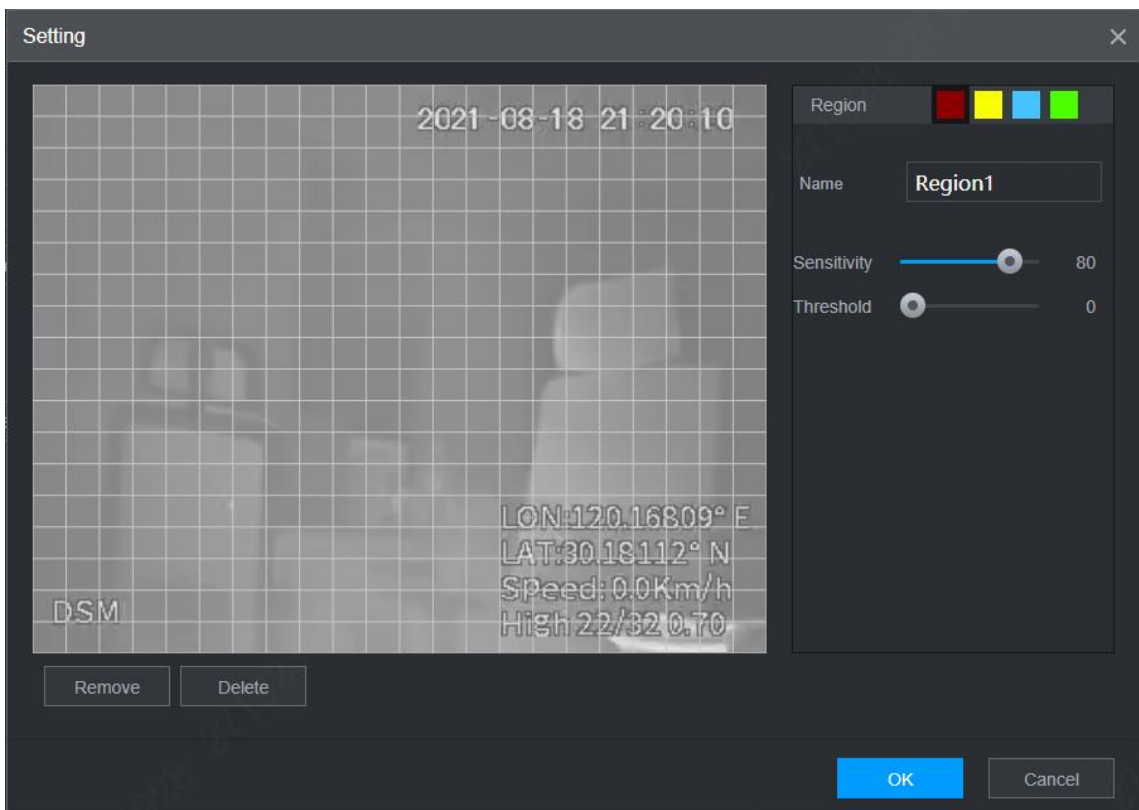

- 2) Select a region and name it.

The higher the sensitivity value is, the easier the motion detection is triggered; the lower the threshold is, the easier the motion detection is triggered. By default, the whole video image is for motion detection.



Different colors represent different regions; you can define different motion detection areas for each region.

- 3) Hold down the left button of the mouse, drag to select the region to be detected, and set up its sensitivity and threshold value.



Channel alarm events: As long as any one of the four regions triggers alarm, the channel that houses the region will give alarm.

- 4) Click **OK** to finish configuration.

**Step 4** Configure alarm linkage parameters. See Table 5-1 for details.

Table 5-1 Alarm linkage parameters description

Parameter	Description
Post-Record	The video recording will not stop until the record delay time you set has passed.
Alarm-out Port	Connect with an alarm device (such as an alarm light or siren) on the alarm output interface, click <b>Setting</b> to set the alarm output device, and activate the alarm linkage output port. When an alarm event takes place, the system can trigger corresponding alarm output devices.
Post-Alarm	Click <b>Setting</b> under <b>Alarm Output</b> to set the delay. Set a length of time during which the device continues alarm output after the alarm ends.
Record Channel	Select the <b>Record Channel</b> check box and select a record channel(s), when an alarm event occurs, the corresponding channel starts recording automatically.  Two more conditions must be satisfied before alarm recording function works: <ul style="list-style-type: none"> <li>• Motion detect recording is enabled. See "5.4.2.2 Snapshot".</li> <li>• Auto recording is enabled. See "3.6 Configuring Record".</li> </ul>
Picture Storage	Select the corresponding check box and set the channel. When an alarm event occurs, the corresponding channel starts capturing automatically.  You can also configure the frequency, size, and quality of snapshot. For details, see "5.4.2.2 Snapshot."
Anti-dither	Click <b>More</b> to set Anti-dither time. The system records only one event during this period.
Log	Click <b>More</b> , and select the corresponding check box to enable the device to create a local alarm log when an alarm event occurs.
Send Email	Click <b>More</b> , and select the corresponding check box. When an alarm event occurs, the system sends email to the specified mailbox.  Set your e-mail first before enabling this function. See "5.5.4 Email" for detailed operations.

Step 5 Click **OK**.

### 5.1.1.2 Video Loss

When video loss occurs, the system triggers an alarm and configured actions.

Step 1 On the main WEB interface, select **Alarm > Video Detection > Video Loss**.

The **Video Loss** interface is displayed. See Figure 5-3.

Figure 5-3 Video Loss

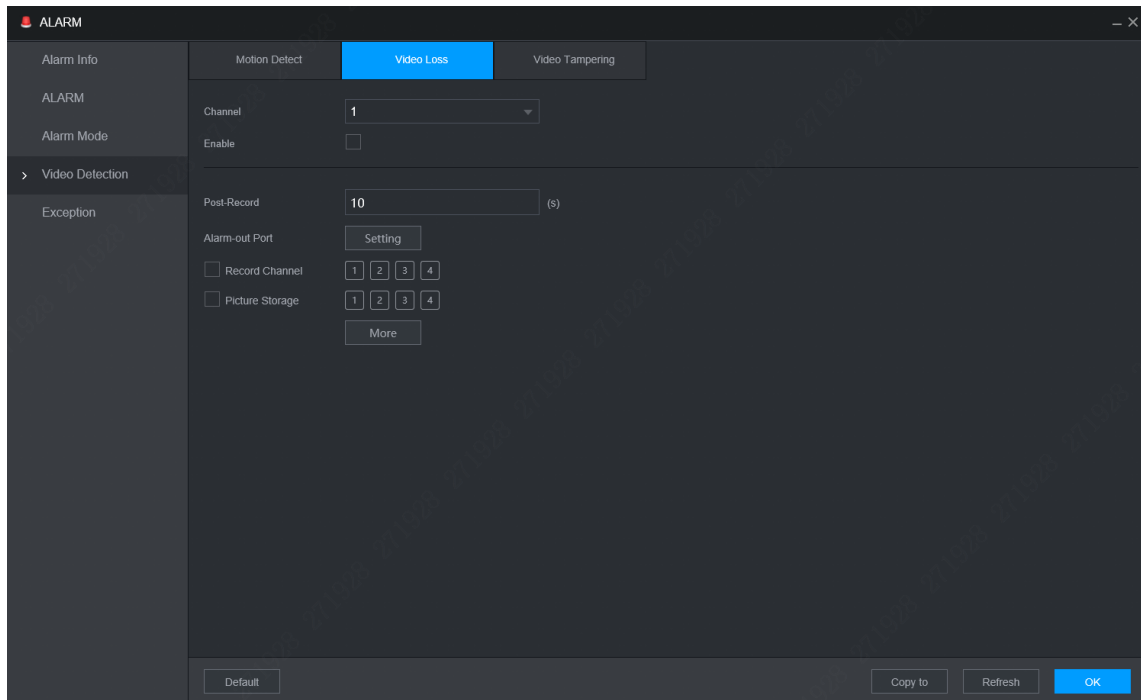

Step 2 Select **Channel** and select **Enable** to enable the video loss detect function for the channel.

Step 3 Configure alarm linkage parameters. See Table 5-1 for details.

Step 4 Click **OK**.

### 5.1.1.3 Video Tampering

When the camera lens is covered, or the video is displayed in a single color because of the causes such as sunlight status, the monitoring cannot be continued normally, and in this case, the system activates alarm and links the configured actions.

Step 1 On the main WEB interface, select **Alarm > Video Detection > Video Tampering**.

The **Video Tampering** interface is displayed. See Figure 5-4.



Figure 5-4 Video tampering

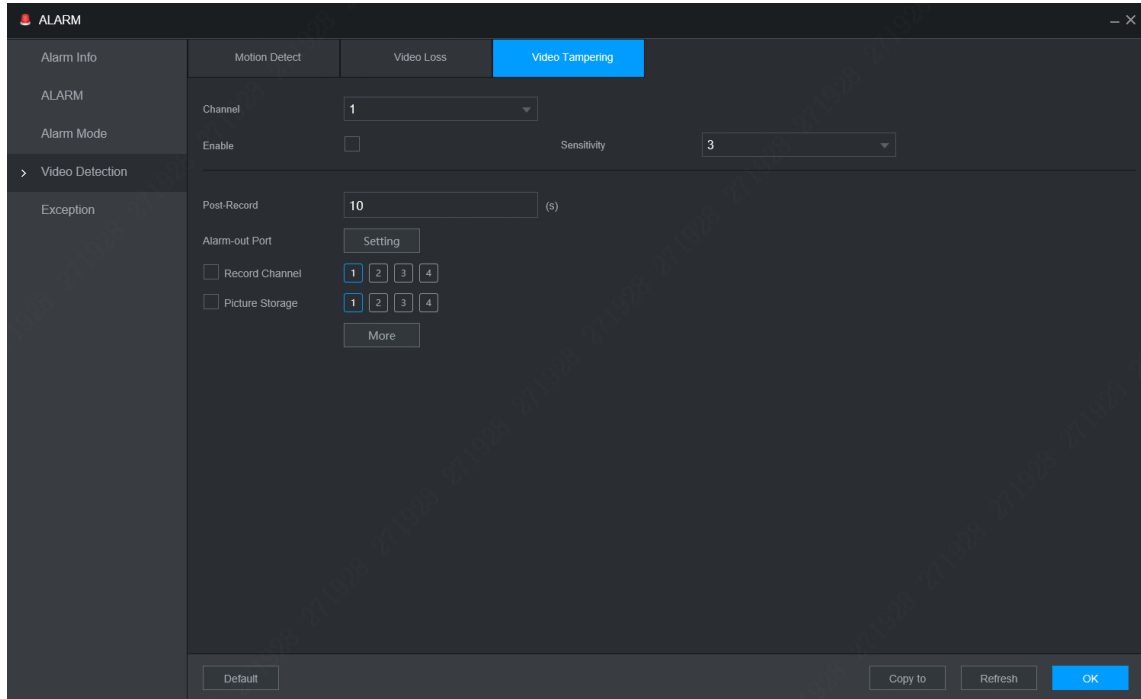

- Step 2** Select **Channel** and select **Enable** to enable the video tampering detect function for the channel.
- Step 3** Set the sensitivity of detection.  
The higher the sensitivity, the easier it is to detect a moving object, but the false alarm rate might increase.
- Step 4** Configure alarm linkage parameters. See Table 5-1 for details.
- Step 5** Click **OK**.

## 5.1.2 Alarm Input

Select different types of input according to alarm sources and set alarm output mode.

- Step 1** On the main WEB interface, select **Alarm > Alarm**.  
The **Alarm** interface is displayed. See Figure 5-5.

Figure 5-5 Alarm

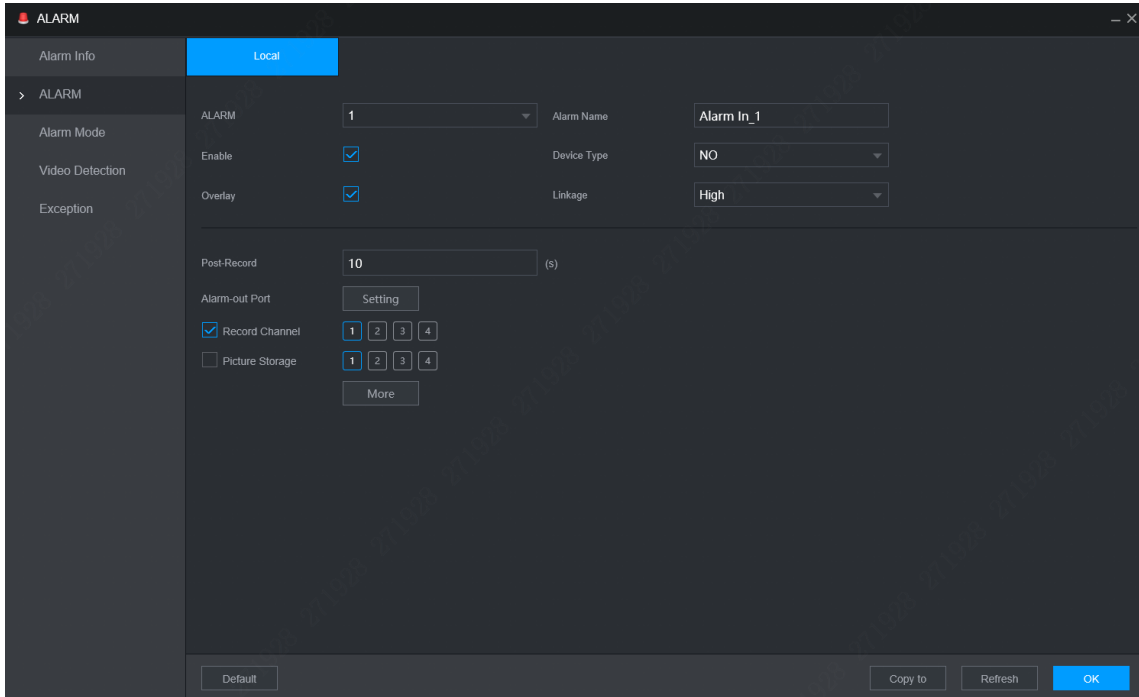



**Step 2** Local: The alarm signal detected by the alarm input port on the device.

**Step 3** Select the channel and select **Enable**.

**Step 4** Configure parameters. For details, see Table 5-2.

Table 5-2 Alarm parameters description

Parameter	Description
Alarm Name	Enter a customized alarm name.
Device Type	If the <b>Event Type</b> is <b>Local Alarm</b> , configure this parameter. <ul style="list-style-type: none"> <li>● NO: The alarm signal is disconnected normally. The alarm is triggered when alarm signal is connected.</li> <li>● NC: The alarm signal is connected normally. The alarm is canceled when alarm signal is disconnected.</li> </ul>
Overlay	Select the <b>Overlay</b> check box to overlay alarm names onto channel images.
Linkage	If the <b>Event Type</b> is <b>Local Alarm</b> , configure this parameter. If the alarm signal is 12V/24V voltage, select <b>High</b> as the triggering mode; if the alarm signal is ground voltage, select <b>Low</b> as the triggering mode.
Post-Record	The video recording will not stop until the record delay time you set has passed.
Alarm-out Port	Connect alarming devices (for example lights and sirens) to the alarm output ports, click the check box, when an alarm is triggered, alarms will be sent to alarm output devices.
Post-Alarm	Click <b>Setting</b> under <b>Alarm-out Port</b> to set the delay time. Set a length of time during which the device continues alarm output after the alarm ends.

Parameter	Description
Record Channel	<p>Select the <b>Record Channel</b> check box and select a record channel(s), when an alarm event occurs, the corresponding channel starts recording automatically.</p>  <p>Two more conditions must be satisfied before alarm recording function works:</p> <ul style="list-style-type: none"> <li>• Alarm recording is enabled. See "3.7.1 Record Schedule".</li> <li>• Auto recording is enabled. See "3.6 Configuring Record".</li> </ul>
Picture Storage	<p>Select the corresponding check box and set the channel. When an alarm event occurs, the corresponding channel starts capturing automatically.</p>  <p>You can also configure the frequency, size, and quality of snapshot. For details, see "5.4.2.2 Snapshot".</p>
Anti-dither	<p>Click <b>More</b> to set the debouncing time.</p> <p>The system records only one alarm input event during the configured period.</p>
Log	<p>Click <b>More</b>, and select the corresponding check box to enable the device to create a local alarm log when an alarm event occurs.</p>
Send Email	<p>Click <b>More</b>, and select the corresponding check box. When an alarm event occurs, the system sends email to the specified mailbox.</p>  <p>Set your e-mail first before enabling this function. See "5.5.4 Email" for detailed operations.</p>

Step 5 Click **OK**.

### 5.1.3 Exception

You can configure the ways to handle the device when errors occur.

Step 1 On the main WEB interface, select **Alarm > Exception**.

The **Exception** interface is displayed. See Figure 5-6.

Figure 5-6 Exception

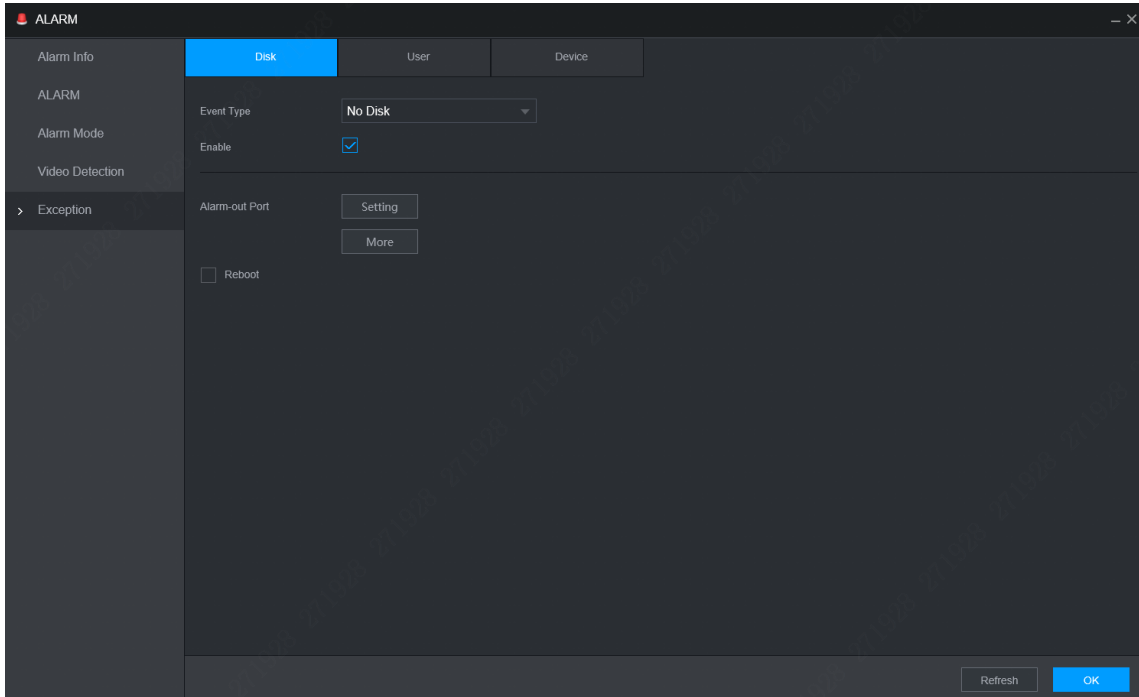

**Step 2** Select the event type, and select **Enable** to enable the handling of corresponding abnormal events.

**Step 3** Configure parameters. For details, see Table 5-3.

Table 5-3 Abnormality parameters description

Parameter	Description
Event Type	<p>You can configure the corresponding abnormal events on following three tabs.</p> <ul style="list-style-type: none"> <li>● Disk: To set the ways to handle abnormal Disk events, including No Disk, HDD Error, Low Space.</li> <li>● User: Includes illegal login.</li> <li>● Device: To set the ways to handle abnormal device events, including High Temperature, Battery Low Space, Network Security Exception, Over Speed, Low Speed, Collision, Turnover, and ACC Power Off.</li> </ul> <p> The supported event type might be different depending on the model you purchased, and the actual interface shall prevail.</p>
Capacity Limit	<p>Select <b>Disk</b> tab, and if the <b>Event Type</b> is <b>Low Space</b>, configure this parameter. You can set the percentage of HDD remaining space. When HDD remaining space is lower than this percentage, an alarm will occur.</p>
Attempt(s)	<p>If the <b>Event Type</b> is <b>Illegal Login</b>, configure this parameter. The maximum number of allowed password input errors during user login. If the number of password input errors reaches this value, the user account will be locked.</p>
Lock Time	<p>If the <b>Event Type</b> is <b>Illegal Login</b>, configure this parameter. If the number of password input errors reaches this value, the user account will be locked.</p>

Parameter	Description
Max Temperature	If the <b>Event type</b> is <b>High Temperature</b> , configure this parameter. Enter the upper limit of device temperature. The alarm is triggered when the device temperature exceeds this value.
Low Than	If <b>Event Type</b> is <b>Battery Low Space</b> , configure this parameter. The supply voltage to the device from the vehicle and the percentage of available supply voltage capacity. When the vehicle is in ACC Off, and the voltage supplied to the device is less than the percentage of available capacity, the system triggers an alarm.
Auto	
Battery Voltage	
Max Speed	If the <b>Event type</b> is <b>Over Speed</b> , configure this parameter. The upper limit of vehicle speed. When the vehicle speed exceeds this value, the system triggers an alarm.
Min Speed	If <b>Event Type</b> is <b>Low Speed</b> , configure this parameter. The lowest limit of vehicle speed. When the vehicle speed is lower than this value, the system triggers an alarm.
Alarm-out Port	Connect alarming devices (for example lights and sirens) to the alarm output ports, click the check box, when an alarm is triggered, alarms will be sent to alarm output devices.
Post-Alarm	Click <b>Setting</b> under <b>Alarm-out Port</b> to set the delay time. Set a length of time during which the device continues alarm output after the alarm ends.
Send Email	Click <b>More</b> , and select the corresponding check box. When an alarm event occurs, the system sends email to the specified mailbox.  Set your e-mail first before enabling this function. See "5.5.4 Email" for detailed operations.
Log	Click <b>More</b> , and select the corresponding check box to enable the device to create a local alarm log when an alarm event occurs.
Reboot	Select the <b>Reboot</b> check box. If No HDD alarm occurs, the system restarts within three minutes.

Step 4 Click **OK**.

## 5.1.4 Alarm Output

Set alarm mode.

Step 1 On the main WEB interface, select **Alarm > Alarm Mode**.

The **Alarm Mode** interface is displayed. See Figure 5-7.

Figure 5-7 Alarm Mode

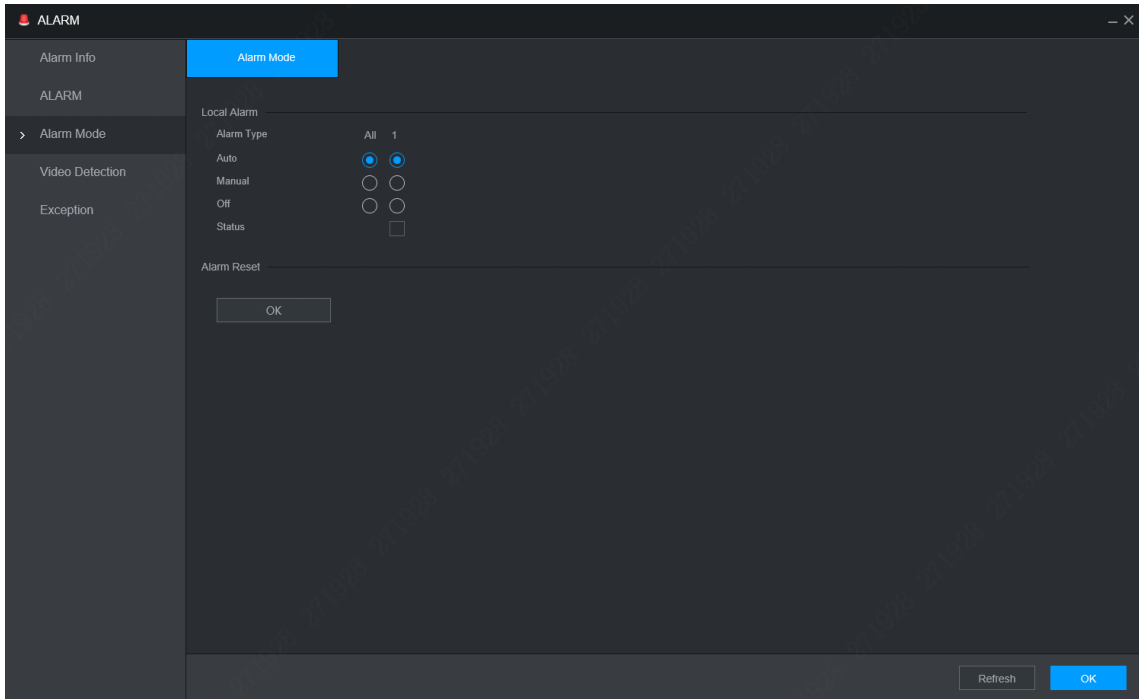

**Step 2** Select alarm mode.

- **Auto:** After the alarm linkage is configured, when an alarm event occurs, the corresponding alarm-out port generates alarm.
- **Manual:** After the alarm linkage is configured, no matter whether there is an alarm event occurs, the corresponding alarm-out port keeps generating alarm.
- **Off:** After the alarm linkage is configured, no matter whether there is an alarm event occurs, the corresponding alarm-out port never generate alarm.

**Step 3** Click **OK**.

**Status:** Indicates the status of each alarm-out port.  indicates there is an alarm output, and  indicates there is not.

## 5.2 Configuring AI Plan

AI solution mainly contains active and safe drive. Only when the smart solution is enabled and set can the corresponding function take effect.

- **ADAS:** Advanced Driver Assistance System for Lane Departure Warning, Headway Monitoring Warning and Forward Collision Warning, and alarm linkage is triggered and reported to the platform.
- **DSM:** The system can analyze and process the driver behavior information collected by cameras, and detect actions such as lowering head, yawning, smoking, looking around, and duration without driver.

### 5.2.1 ADAS

ADAS alarms mainly include Forward Collision Warning, Lane Departure Warning and Headway Monitoring Warning.

## Prerequisites

- Access to cornering lamp signal in advance: Alarm Input\_2 (turn left), Alarm Input\_3 (turn right). After the cornering lamp of the vehicle is turned on, no Lane Departure alarm will be triggered.
- Config: Driver assistance relies on the camera installation location, and cannot be used until the calibration is completed. Try to install the camera in the middle of the windshield. When configuring parameters, measure the width of the vehicle, the height of the camera, and the distance from the camera to the vehicle head in advance. After the vehicle travels for a certain period of time, the device will automatically calibrate the position.

## Procedure

- Step 1** On the main WEB interface, click **AI > Parameters > ADAS**.  
The **ADAS** interface is displayed. See Figure 5-8.

Figure 5-8 ADAS

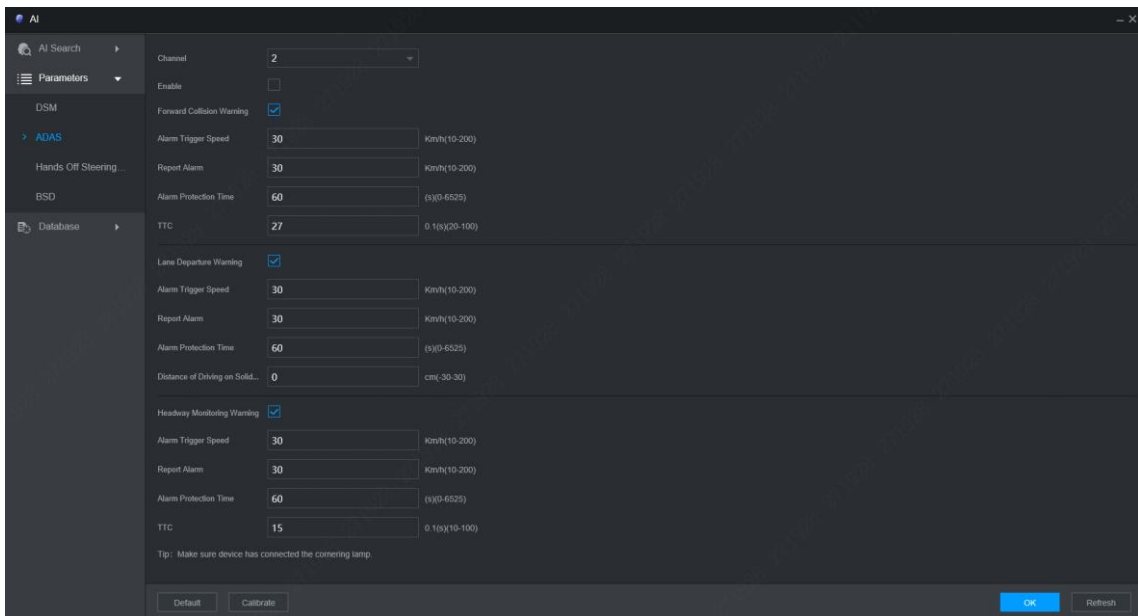

- Step 2** Click **Enable** and **OK** to enable the ADAS alarm.

- Step 3** Click **Calibrate**.

The **Calibrate** interface is displayed. See Figure 5-9.

Figure 5-9 Calibrate

Vehicle Width	500	mm(500-3000)
Lens Height	100	mm(100-5000)
Distance from Camera to Ve...	0	mm(0-5000)
Calibration Status	Uncalibrated	

**Step 4** Enter the vehicle width, the lens height and the distance from the camera to the vehicle head, and click **OK** to complete the calibration.

**Step 5** Click  to return to the Figure 5-8 interface.

**Step 6** Configure parameters. For details, see Table 5-4.



means the corresponding alarm is enabled.

Table 5-4 ADAS parameters description

Parameter	Description
Channel	ADAS is fixed to channel 2.
Forward Collision Warning	Give a warning if it is possible to collide with the vehicle in the front.
Alarm Trigger Speed	The speed at which the Forward Collision Warning is triggered: The range is 30km/h–200km/h.
Report Alarm	The speed at which the Forward Collision Warning is uploaded: The range is 30km/h–200km/h.
Alarm Protection Time	Continuous alarm time: The range is 1s–65536s.
TTC	Time to collision: The range is 0s–10s.
Lane Departure Warning	Alarm when the vehicle directly changes the lane without turning on the left or right cornering lamp.
Alarm Trigger Speed	The speed at which the Lane Departure Warning is triggered: The range is 30km/h–200km/h.
Report Alarm	The speed at which the Lane Departure Warning is uploaded: The range is 30km/h–200km/h.
Alarm Protection Time	Continuous alarm time: The range is 1s–65535s.



Parameter	Description
Distance of Driving on Solid Line	Set the distance of driving on solid line: The range is -30cm–30cm.
Headway Monitoring Warning	Alarm when the vehicle is too close to the vehicle in the front.
Alarm Trigger Speed	The speed at which the Headway Monitoring Warning is triggered: The range is 30km/h–200km/h.
Report Alarm	The speed at which the Headway Monitoring Warning is uploaded: The range is 30km/h–200km/h.
Alarm Protection Time	Continuous alarm time: The range is 1s–65535s.
TTC	Time to collision: The range is 0s–10s.

**Step 7** Click **OK**.

## 5.2.2 DSM

DSM alarms mainly include drowsy driving, distracted driving, calling, no driver, wearing IR blocking sunglasses, smoking, lens tampering, and unbelted Alarm. After being triggered, these alarms require voice broadcast and need to be uploaded to the platform.

**Step 1** On the main WEB interface, click **AI > Parameters > DSM**.

The **DSM** interface is displayed. See Figure 5-10.

Figure 5-10 DSM

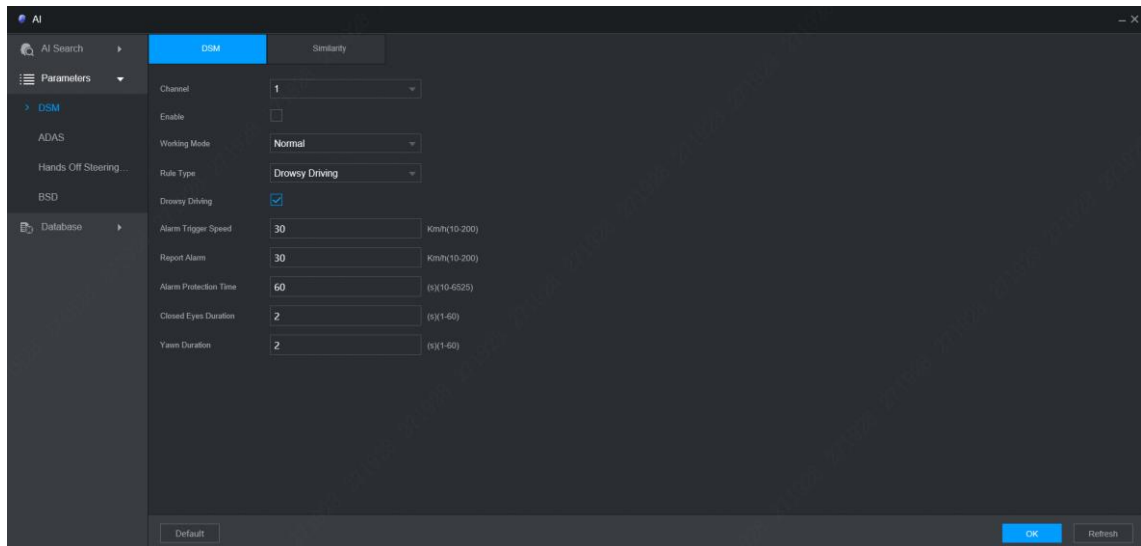

**Step 2** Click **Enable** to enable the DSM alarm.

**Step 3** Configure parameters. For details, see Table 5-5.

Table 5-5 Parameters description

Parameter	Description
Channel	DSM is fixed to channel 1.
Working Mode	Working modes include normal mode and test mode.

Parameter	Description
Rule Type	For alarm rules, you can select drowsy driving, distracted driving, calling, no driver, wearing IR blocking sunglasses, smoking, lens tampering, and unbelted Alarm.  <input checked="" type="checkbox"/> means the corresponding alarm is enabled.
Alarm Trigger Speed	The speed at which the alarm is triggered: The range is 30km/h–200km/h.
Report Alarm	The speed at which the alarm is uploaded: The range is 30km/h–200km/h.
Alarm Protection Time	Continuous alarm time: The range is 1s–65536s.
Closed Eyes Duration	Setting is necessary when the rule type is <b>Drowsy Driving</b> : The range is 1s–10s.
Yawn Duration	
Lowering Head Duration	Setting is necessary when the rule type is <b>Distracted Driving</b> : The range is 1s–10s.
Looking around Duration	
Calling Duration	Setting is necessary when the rule type is <b>Calling</b> : The range is 1s–10s.
Duration without Driver	Setting is necessary when the rule type is <b>No Driver</b> : The range is 2s–10s.
Duration of Wearing Infrared-blocking Sunglasses	Setting is necessary when the rule type is <b>Wearing IR Blocking Sunglasses</b> : The range is 1s–10s.
Smoking Duration	Setting is necessary when the rule type is <b>Smoking</b> : The range is 1s–10s.
Tampering Duration	Setting is necessary when the rule type is <b>Lens Tampering</b> : The range is 1s–10s.

Step 4 Click **OK**.

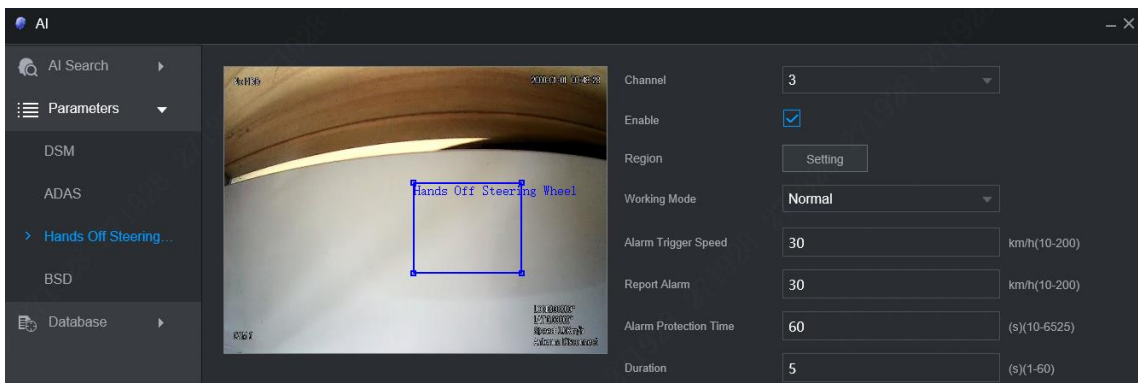

Select a channel from Channel 3 to Channel 4 to enable the detection.

## 5.3 File Backup

You can backup video recordings and images.

**Step 1** On the main WEB interface, click **Backup**.

The **Backup** interface is displayed. See Figure 5-11.

Figure 5-11 Backup (1)

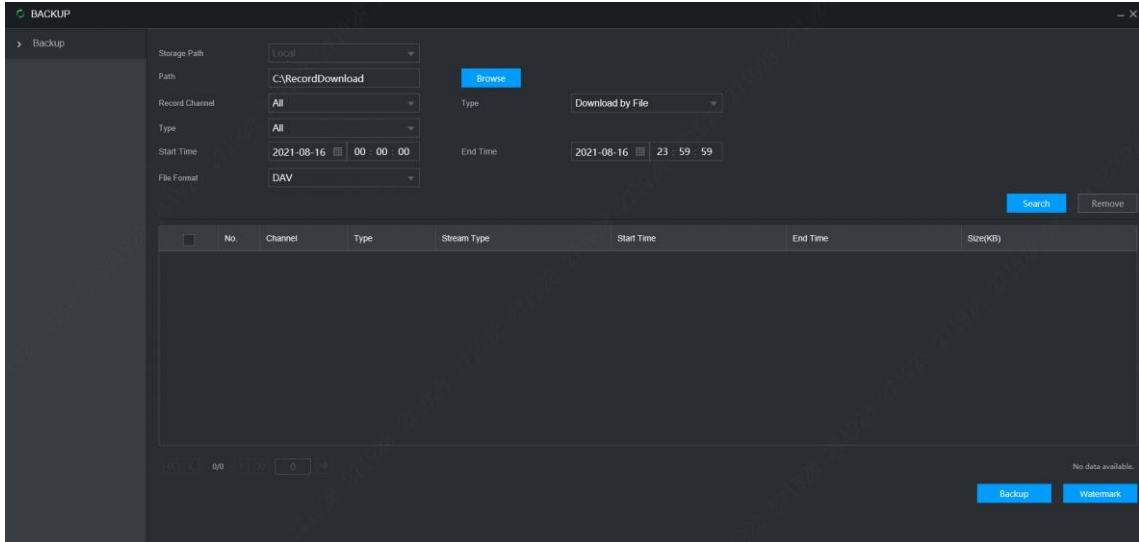

**Step 2** Configure parameters. For details, see Table 5-6.

Table 5-6 Backup parameters

Parameter	Description
Storage Path	Only local path is supported.
Path	File backup path is C:/RecordDownload by default. Click <b>Browse</b> to set the backup path as needed.
Record Channel	Select the channel you want to back up.
Type	Select the backup type, including download by file and download by time.
Start time	Set the file backup period.
End Time	
File Format	Select the backup file format, including DAV and MP4.
Type	Select the record type, including Alarm, Motion, M&A, Genral, Picture, and All.

**Step 3** Click **Search**.

The obtained files are displayed.

**Step 4** Select the file that you want to back up, and click **Backup**.

The **Backup** button is changed to **Download** now. See Figure 5-12.

Figure 5-12 Backup (2)

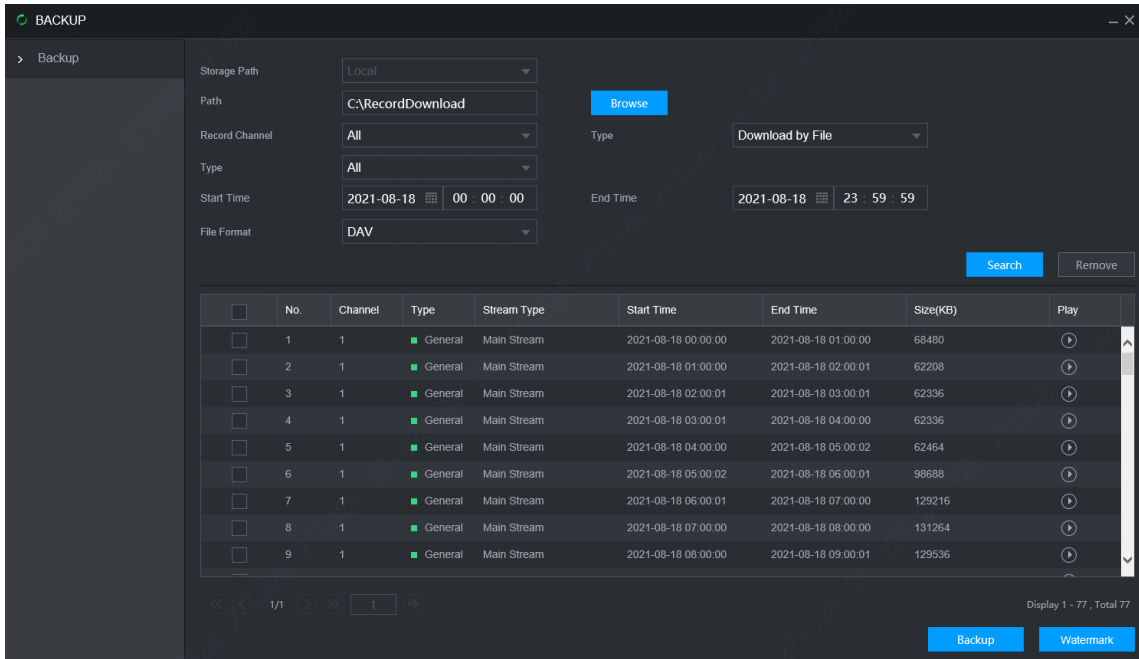

**Step 5** Click View Download.

The **View Download** interface is displayed. See Figure 5-13.

Figure 5-13 View Download

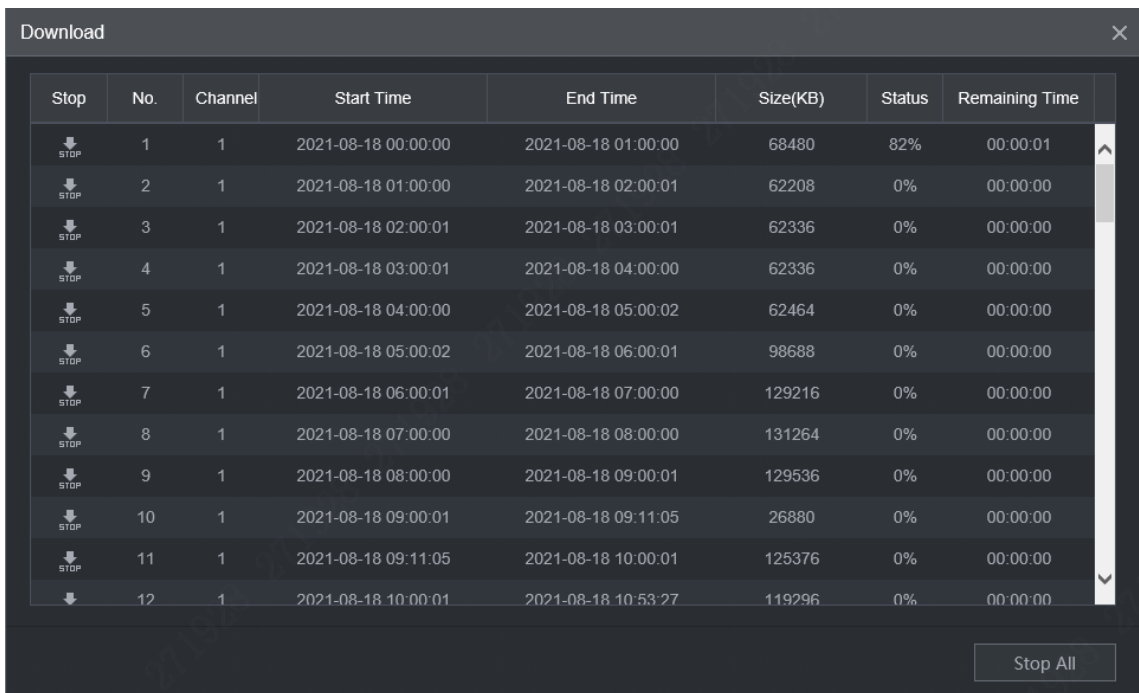

Click **Stop All** to stop downloading.

**Step 6** (Optional) Select the file that you want to verify, and click **Watermark**.



**Watermark** can be used to verify whether the record file is falsified.

The verifying progress and result are displayed.

## 5.4 Configuring Camera Parameter

You can set camera properties and encode parameters.

### 5.4.1 Camera Properties

You can set up the camera property parameters of the channel.



Different cameras correspond to different property parameters. The actual parameters shall prevail.

**Step 1** Select **Setting > Camera > Image**.

The **Image** interface is displayed. See Figure 5-14.

Figure 5-14 Image

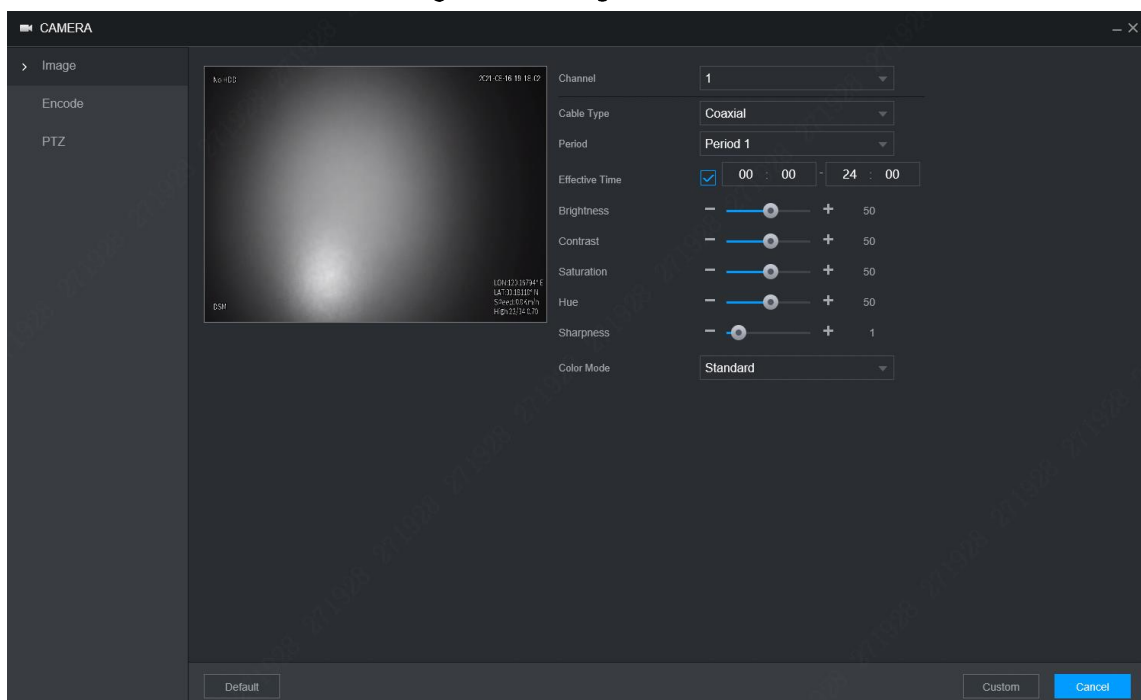

**Step 2** Select a **Channel**.

**Step 3** Configure parameters. For details, see Table 5-7.

Table 5-7 Image setting parameters description

Parameter	Description
Cable Type	The cable type is fixed to coaxial.
Period	Select the period. There are two Periods for you. You should set up the Effective Time for different periods.
Brightness	Adjusts the image brightness through linear mode. The bigger the value is, the brighter the image will become.
Contrast	Adjust the image contrast. The bigger the value is, the more obvious the contrast between the light area and dark area will become.
Saturation	Adjusts the color darkness. Adjust the saturation according to the actual situation. The bigger the value, the lighter the color of the image will become.

Parameter	Description
Hue	Adjusts the color hue. Adjust the hue according to the actual situation. The bigger the value, the colder the color of the image will become.
Sharpness	Set the sharpness of picture edges. The bigger the value is, the more obvious the image edge will become.
Hue	Adjusts the color darkness. Adjust the saturation according to the actual situation. The bigger the value, the lighter the color of the image will become.
Color Mode	Select the color mode. There are 5 preinstall modes you can choose, or you can set 4 custom modes for options. Preinstall modes includes Standard, Soft, Bright, Vivid, Bank.

**Step 4** Click **OK**.

## 5.4.2 Encode Parameters

You can set **Audio/Video**, **Snapshot**, **Overlay**, and **Storage Path**.

### 5.4.2.1 Audio/Video

You can configure the encode settings for main stream and sub stream.

**Step 1** Select **Setting > Camera > Encode > Audio/Video**.

The **Audio/Video** interface is displayed, see Figure 5-15.



Encode parameters might be different depending on devices, and the actual product shall prevail.

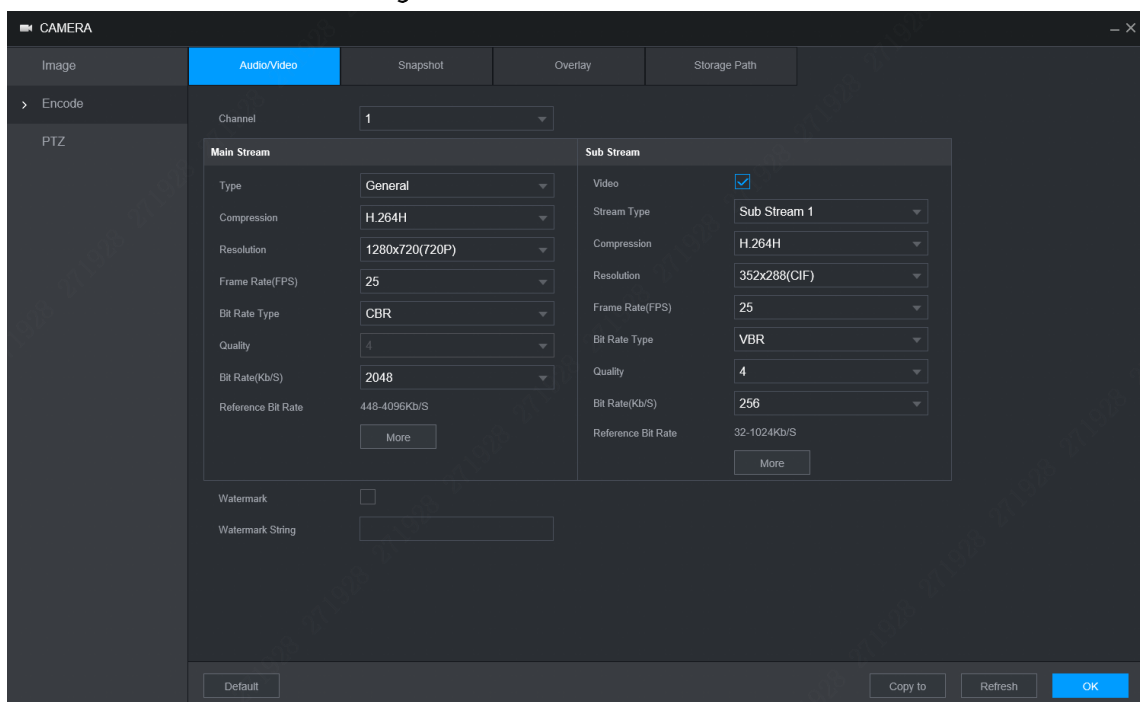

Figure 5-15 Audio/Video



**Step 2** Select a channel number.

**Step 3** Configure parameters. For details, see Table 5-8.

Table 5-8 Encode setting parameters description

Parameter	Description
Video	Enable the sub stream.
Type	The record type of main stream is permanently fixed as general and cannot be changed. General, motion detect and alarm use the general stream configurations for recording.
Stream Type	Sub stream types.
Compression	Encode mode of video.
Resolution	The higher the video resolution, the better the image quality.
Frame rate (FPS)	Configure the frames per seconds for videos. The higher the value, the smoother and more vivid the image.
Bit rate type	<p>Select a control mode for bit rate of video.</p> <ul style="list-style-type: none"> <li>● CBR: The bit rate changes little and keeps close to the defined bit rate value.</li> <li>● VBR (Variable Bit Rate): The bit rate changes along with environment.</li> </ul>  <ul style="list-style-type: none"> <li>● It is recommended to select CBR when there might be only small changes in the monitoring environment, and select VBR when there might be big changes in the monitoring environment.</li> <li>● The main stream is fixed to VBR.</li> </ul>
Quality	This parameter can be configured only when the <b>Bit Rate Type</b> is set as <b>VBR</b> . Select the image quality level. There are six levels in total. The higher the value, the better the image will become.
Bit rate(KB/S)	<p>Configure the encode value for main stream and sub stream.</p> <ul style="list-style-type: none"> <li>● When <b>CBR</b> is selected, select the bit rate according to the reference bit rate, and the bit rate changes along the configured value.</li> <li>● When <b>VBR</b> is selected, select the upper limit value of bit rate according to the reference bit rate, and the bit rate changes along with the monitoring environment. But the maximum bit rate value changes around the configured value.</li> <li>● Select <b>Customized</b>, and you can configure bit rate value manually.</li> </ul>
Reference Bit Rate	The system recommends the optimal bit rate range according to the resolution and frame rate settings.
Audio Enable	<p>Click <b>More</b> to enable the audio.</p> <p>If the corresponding check box is selected, the video recordings are audio and video combined streams.</p>
Compression	<p>Select an audio encode format.</p>  <p>The parameters might be different depending on the model you purchased, and the actual product shall prevail.</p>
Audio Source	Source of audio.
Watermark	Select the <b>Watermark</b> check box to verify whether the recorded video is falsified.
Watermark String	Enter the strings for verifying watermark. The default string is DigitalCCTV. You can configure at most 127 watermark characters which are composed of number, letter, underline and dash.

Step 4 Click **OK**.

### 5.4.2.2 Snapshot

You can configure the snapshot settings such as snapshot type, image size, quality, and interval.

**Step 1** Select **Setting > Camera > Encode > Snapshot**.

The **Snapshot** interface is displayed, see Figure 5-16.

Figure 5-16 Snapshot

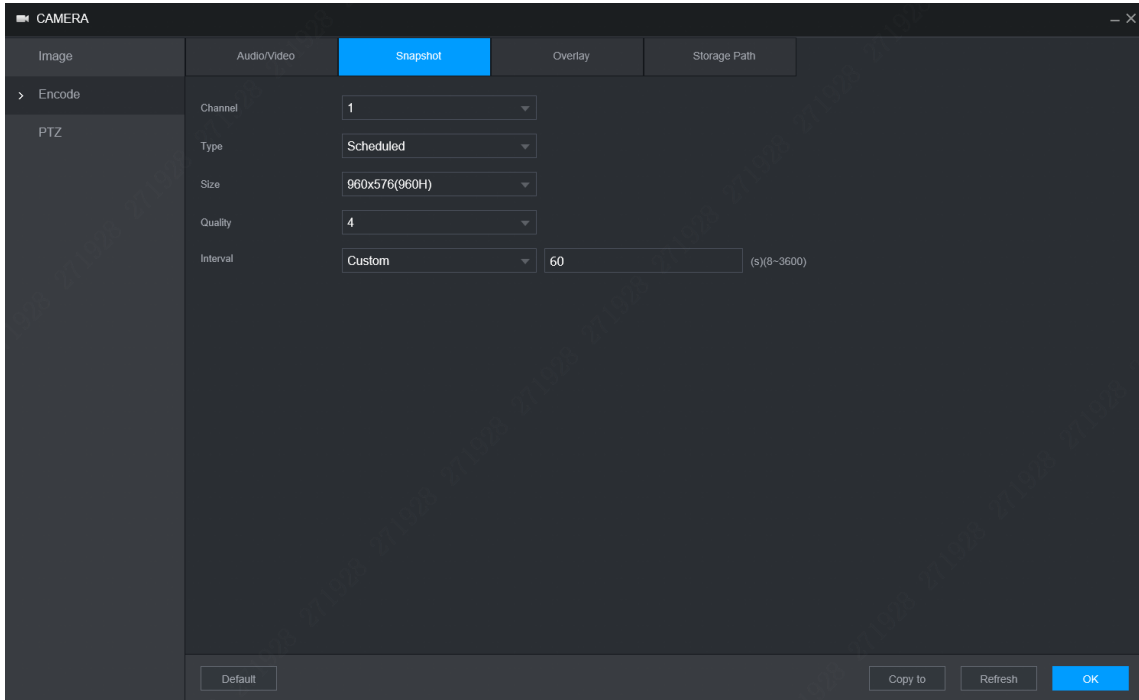

**Step 2** Select **Channel**.

**Step 3** Configure parameters. For details, see Table 5-9.

Table 5-9 Snapshot stream parameters description

Parameter	Description
Type	Includes scheduled and event. <ul style="list-style-type: none"> <li>● Schedule: Take snapshots within the configured period.</li> <li>● Event: Take snapshots when alarms such as local alarm, video detection and abnormality are triggered.</li> </ul>
Size	Select a resolution for the captured image.
Quality	The image quality and there are six levels in total.
Interval	Interval of taking snapshots. Select <b>Custom</b> to configure the snapshot interval for manually captured snapshots. The maximum value you can set is 3600 seconds as an interval between two snapshots.

**Step 4** Click **OK**.

### 5.4.2.3 Overlay

You can configure to display the information such as system time and channel name on each channel window in the live view screen.

**Step 1** Select **Setting > Camera > Encode > Overlay**.



The **Overlay** interface is displayed. See Figure 5-17.

Figure 5-17 Overlay

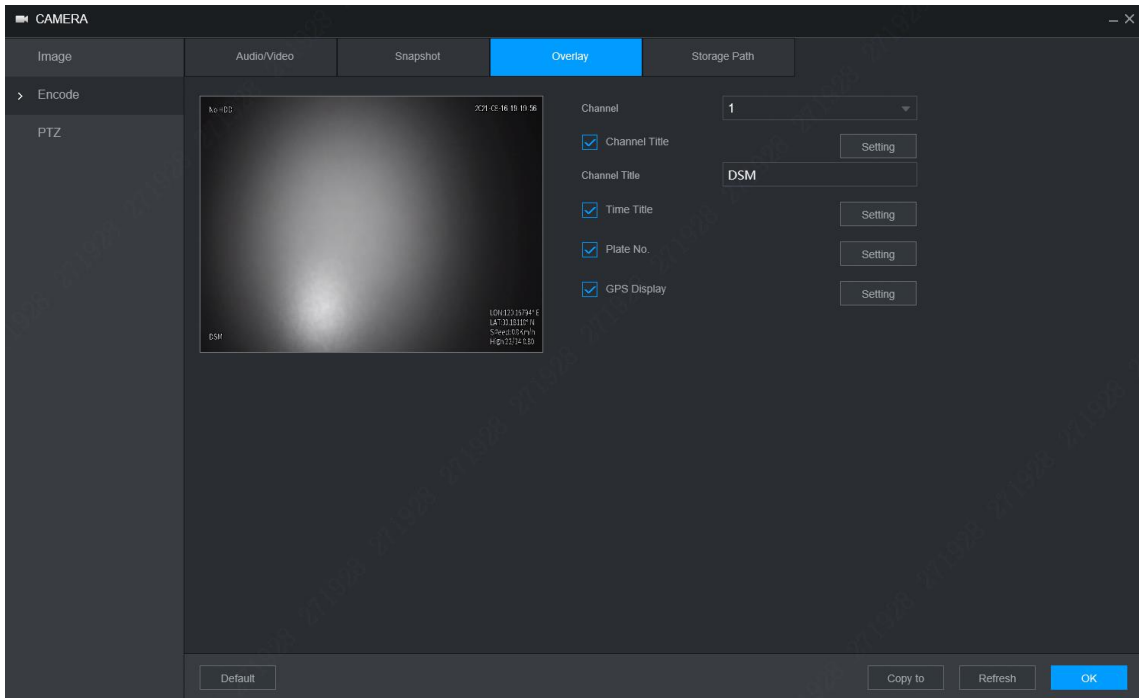

**Step 2** Select a **Channel**.

**Step 3** Configure parameters. For details, see Table 5-10.

Table 5-10 Video overlay settings parameters description

Parameter	Description
Channel Title	Select <b>Channel Title</b> , and the <b>Setting</b> button is displayed. Then click <b>Setting</b> on the right of the <b>Channel Title</b> , enter the channel title, and drag it to a proper location.
Time Title	Select the <b>Time Title</b> check box, the <b>Setting</b> button is displayed. Then click <b>Setting</b> , the time is displayed on the channel window, and then drag it to a proper location.
Plate No	Select the <b>Plate No</b> check box, the <b>Setting</b> button is displayed. Then click <b>Setting</b> , the plate number is displayed on the channel window, and then drag it to a proper location.
GPS Display	Select the <b>GPS Display</b> check box, the <b>Setting</b> button is displayed. Then click <b>Setting</b> , the GPS display frame is displayed on the channel window, and then drag it to a proper location.

**Step 4** Click **OK**.

### 5.4.2.4 Storage Path



You can configure the storage path of captured snapshots and recorded videos.

**Step 1** Select **Setting > Camera > Encode > Storage Path**.

The **Storage Path** interface is displayed. See Figure 5-18.

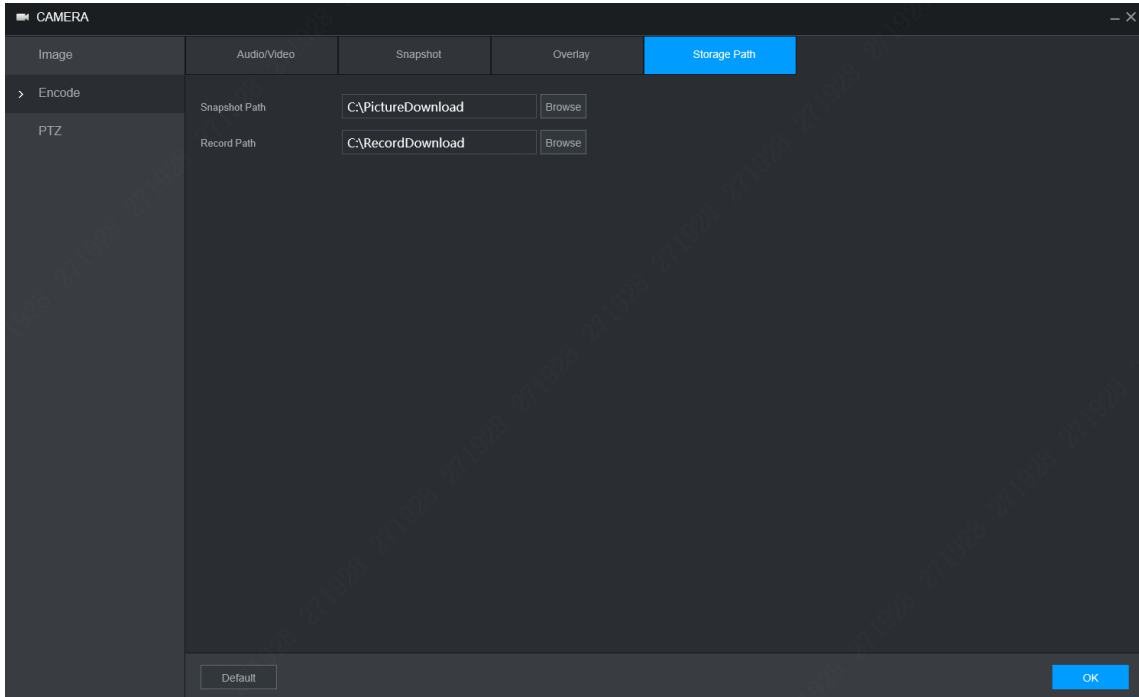
Figure 5-18 Storage path



**Step 2** Click **Browse** to select the storage path for snapshots and recordings. Images and recordings by using functions of snapshots  and recordings  on the **Live** interface are saved in these two paths by default. Default paths: C:\PictureDownload and C:\RecordDownload.

**Step 3** Click **OK**.

## 5.5 Configuring Network Parameters

You can set the network parameters of the device as needed, including ports, Wi-Fi parameters, 3G/4G parameters, Email, auto register, P2P, and Operation platform.

### 5.5.1 Port

Set each port value of the device.

**Step 1** Select **Setting > Network > Port**.

The **Port** interface is displayed. See Figure 5-19.

Figure 5-19 Port

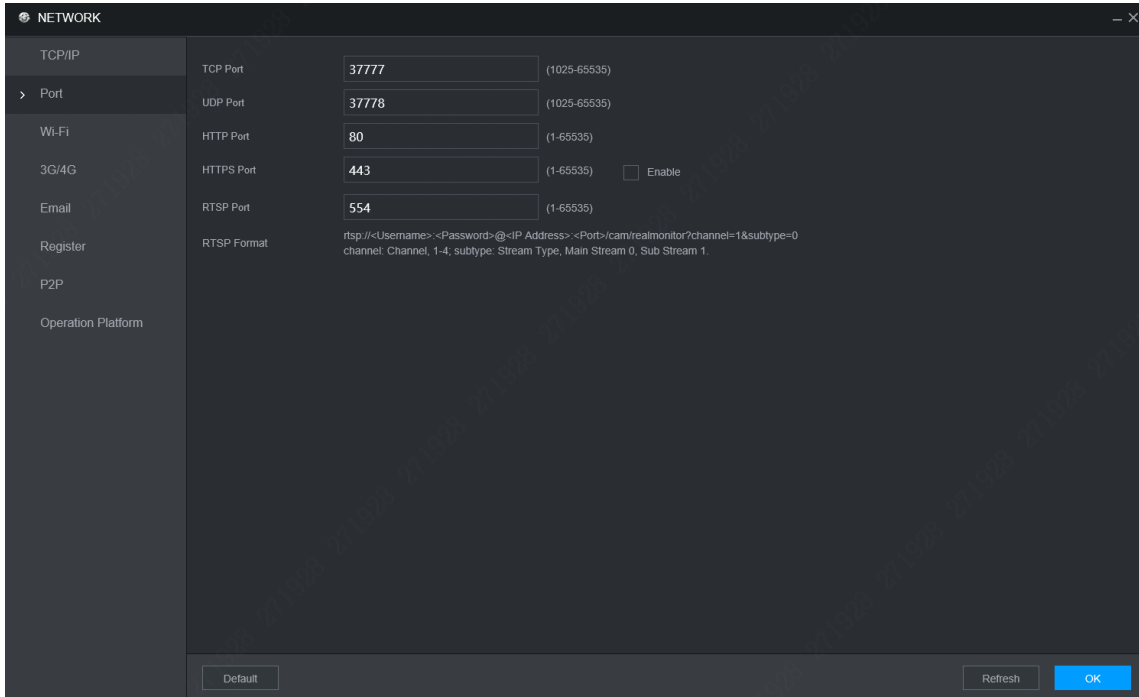

**Step 2** Configure the ports of the device. For details, see Table 5-11.



The revised settings take effect after device restart. Proceed with caution.

Table 5-11 Port parameters description

Parameter	Description
TCP Port	Transmission control protocol port. The value is 37777 by default.
UDP Port	User Datagram Protocol port. The default value setting is 37778. You can enter the value according to your actual situation.
HTTP Port	Hyper Text Transfer Protocol port. The default setting is 80. You can enter the value according to your actual situation, and in this case, please add the modified port number after the address when logging the device on the browser.
HTTPS Port	Hyper Text Transfer Protocol over Secure Socket Layer port. Select the Enable check box, and then enter the value as needed. The value is 443 by default.

Parameter	Description
RSTP Port	<p>Real Time Streaming Protocol port. Keep the default value 554 if it is displayed. If you play live view through Apple's QuickTime or VLC, the following format is available. This function is also available for Blackberry.</p> <p>When the URL format requiring RTSP, you need to specify channel number and bit stream type in the URL, and also user name and password if needed.</p> <p>When playing live view with Blackberry smart phone, you need to turn off the audio, and then set the code mode to H.264B and resolution to CIF.</p> <p>URL format example:  <code>rtsp://&lt;User Name&gt;:&lt;Password&gt;@&lt;IP Address&gt;:&lt;Port&gt;/cam/realmonitor?channel=1&amp;subtype=0</code></p> <ul style="list-style-type: none"> <li>● User name. For example: admin.</li> <li>● Password: For example: admin_123.</li> <li>● IP address: For example, 192.168.1.16.</li> <li>● Port: The default setting is 554. If the default setting is displayed, you do not need to configure this parameter.</li> <li>● Channel: Numbers from 1. For example, if it is channel 2, then enter channel=2.</li> <li>● Subtype: stream type. The main stream is 0 (subtype=0); the sub stream is 1 (subtype=1).</li> </ul> <p>For example, if you require the sub stream of channel 2 from a device, then the URL shall be:  <code>rtsp://admin:admin_123@192.168.1.16:554/cam/realmonitor?channel=2&amp;subtype=1</code></p> <p>If certification is not required, you do not need to specify the user name and password: Use the following format:  <code>rtsp:// &lt;IP Address&gt;:&lt;Port&gt;/cam/realmonitor?channel=1&amp;subtype=0</code></p>

**Step 3** Click **OK**.

## 5.5.2 Wireless Network

You can connect the device to a network through Wi-Fi. Make sure the device can communicate with other devices in the group network. The device itself can also act as a hot spot to share flows with other terminals.



If both 3G/4G and Wi-Fi are available, the device connects to Wi-Fi and disconnects from 3G/4G.

### 5.5.2.1 Wi-Fi

You can connect the device to a network through Wi-Fi. Then connect the PC to the same network. You can log in to the WEB interface by PC to operate the device.



This function is only supported on the device with a Wi-Fi module. The actual situation shall prevail.

## Prerequisites

Make sure that the device is connected to a Wi-Fi module.

## Procedure

**Step 1** Select **Setting > Network > Wi-Fi**.

The **Wi-Fi** interface is displayed.

**Step 2** Select **Wi-Fi** as the working mode.

The **Wi-Fi** interface is displayed, see Figure 5-20.

Figure 5-20 Wi-Fi

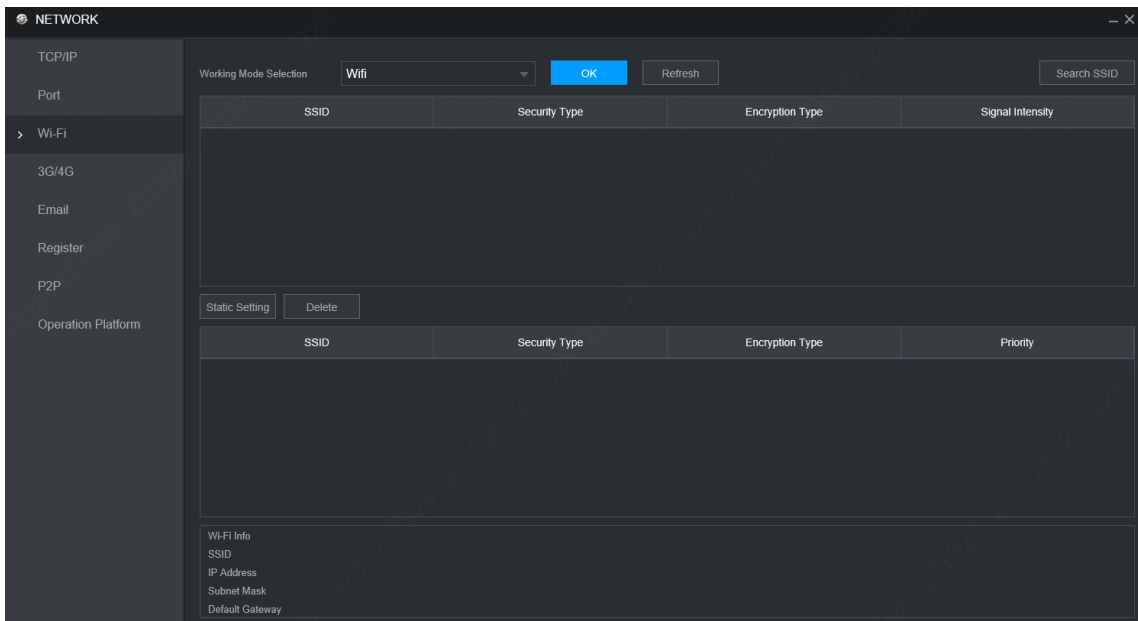

**Step 3** Connect to Wi-Fi.

- Auto search
  1. Click **Search SSID**.  
The available Wi-Fi networks list including the information such as connection mode, authorization mode, and signal intensity.
  2. Double-click the Wi-Fi you need, enter the password and click **OK**.
- Add Wi-Fi manually
  1. Click **Static Setting**.  
The **Wi-Fi** interface is displayed. See Figure 5-21.

Figure 5-21 Wi-Fi setting

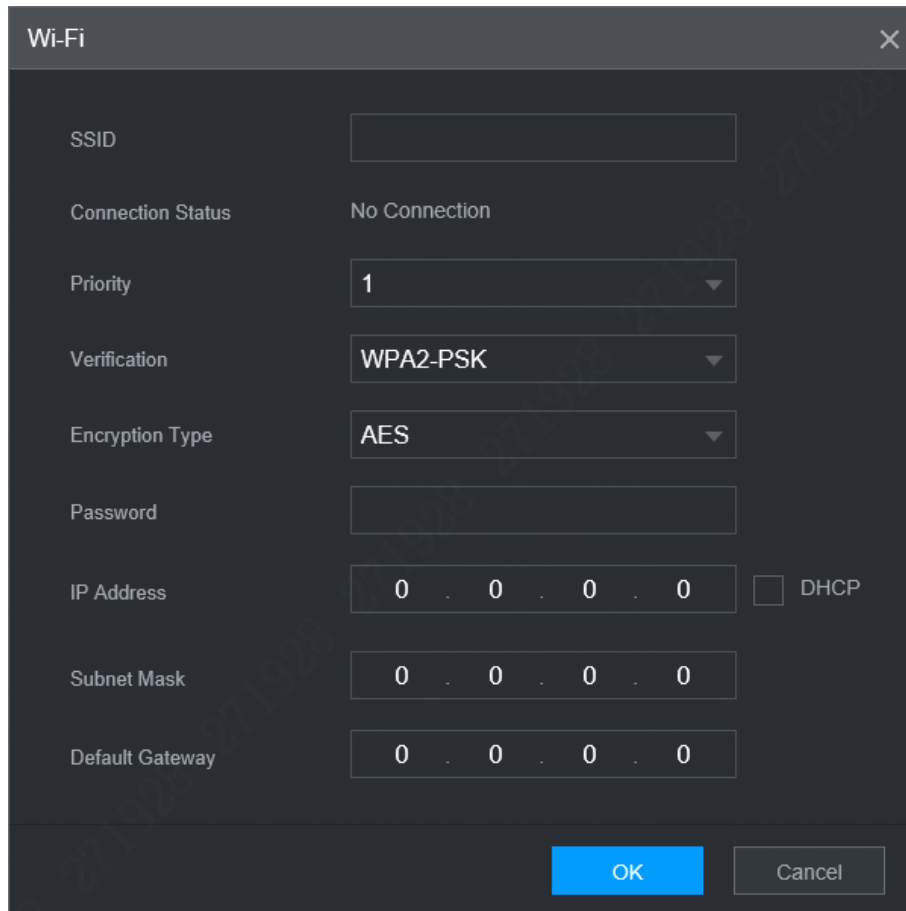

2. Enter SSID and password, select priority level, verification type and authentication type, set IP address, subnet mask, and default gateway.  
If you select **DHCP** check box, after successful connection, the system automatically obtains the IP address, subnet mask, and gateway.
3. Click **OK**.

**Step 4** Click **OK**.

Click **Refresh** to refresh the connection status.

After successful connection, you can view the current hot spot, IP address, subnet mask, and gateway in **Wi-Fi Info**.

### 5.5.2.2 Ap

The device can work as a hotspot to share the network connection to other terminals. The terminals connected to the hot spot can log in to the device through host IP address (192.168.0.108). After login, you can view videos on the device.

**Step 1** Select **Setting > Network > Wi-Fi**.

The **Wi-Fi** interface is displayed.

**Step 2** Select **Ap** as the working mode.

The **Ap** interface is displayed. See Figure 5-22.

Figure 5-22 Ap setting

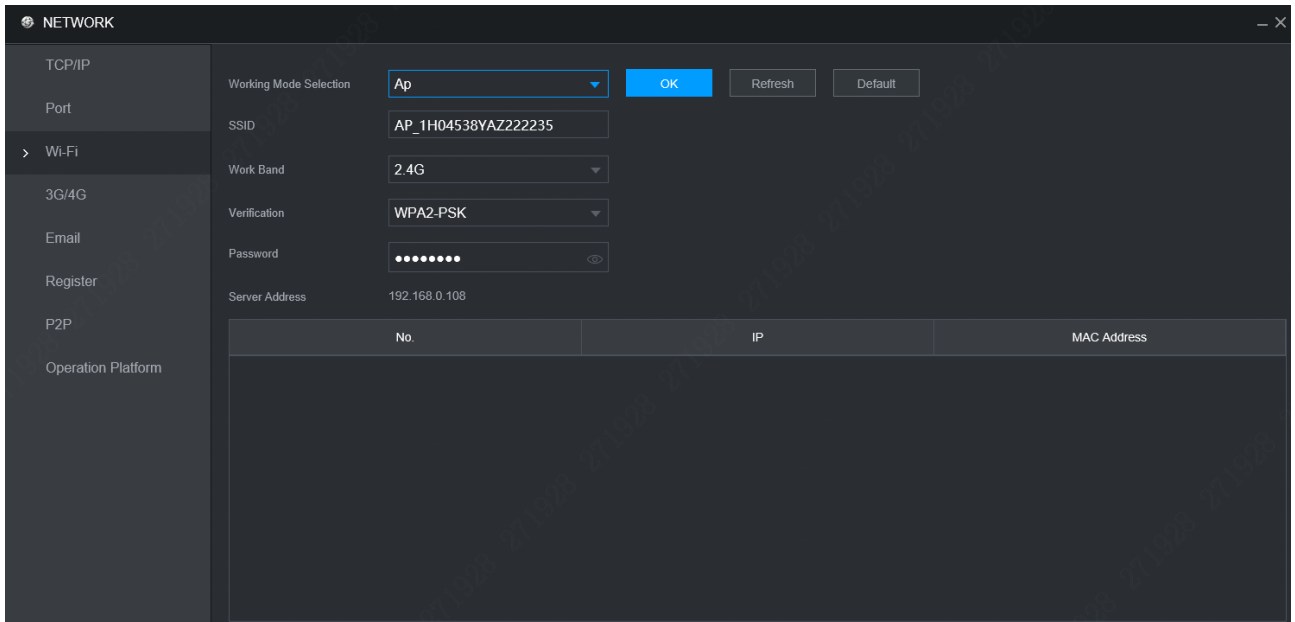

**Step 3** Enter SSID information, select work band and verification, and then enter the password.

- The work band can only be 2.4G.
- Select the check box behind **Password**, and the password will be visible. The default password is 12345678.

**Step 4** Click **OK**.

### 5.5.3 3G/4G

#### Prerequisites

- Make sure the device is equipped with 3G/4G module and inserted with SIM card from the Communication Operator.
- The dial number, user name, and password have been obtained from the Communication Operator.

#### Procedure

**Step 1** Select **Setting > Network > 3G/4G**.

The **3G/4G** interface is displayed. See Figure 5-23.



After 3G/4G module is connected, the module information and wireless signal are displayed; if not, click **Search** to search for wireless signal.

Figure 5-23 3G/4G

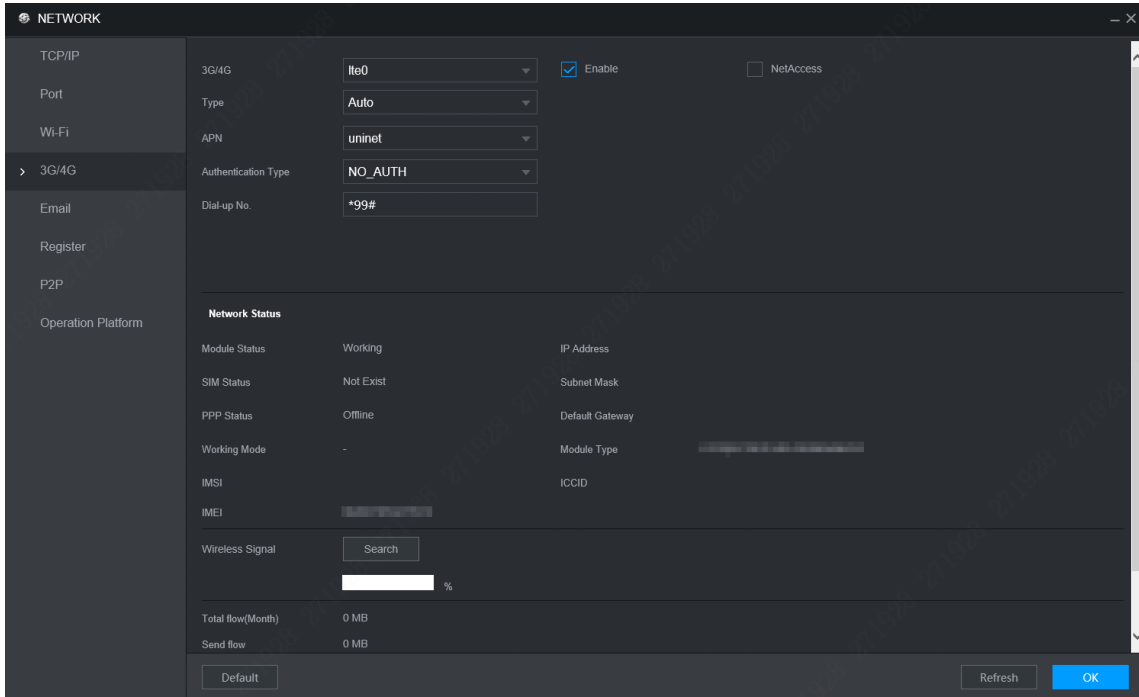

**Step 2** Select **3G/4G** and **Enable** to enable the network. This function is enabled by default.

**Step 3** Configure parameters. For details, see Table 5-12.

Table 5-12 3G/4G setting parameters description

Parameter	Description
NetAccess	When the Device is accessed to private network, select the <b>NetAccess</b> check box, enter APN name and select authentication mode. If <b>PAP</b> or <b>CHAP</b> is selected for authentication mode, enter user name and password, then the device is automatically accessed to private network.
Type	When enabled, the network type is displayed, which is used to distinguish between the 3G/4G modules of different communication operators, such as TD-LTE.
APN	Displays access point of Communication Operator. To manually set up <b>APN</b> , select <b>Customized</b> .
Authentication Type	Includes PAP, CHAP, and NO_AUTH protocols. The system automatically recognizes and displays the enabled protocol.
Dial-up No	Enter the dial number provided from the Communication Operator.
User Name	This parameter needs to be set up when AUTH is set to PAP or CHAP.
Password	The system automatically recognizes the user name and password.
Network Status	After successful dial-up, all relevant information is displayed without any setup needed. Such information includes module status, SIM status, PPP status, working mode, IMSI, IMEI, IP address, subnet mask, gateway, and module type.
Wireless Signal	Click <b>Search</b> to search for wireless signals.

**Step 4** Click **OK**.

After access is succeeded, the obtained IP address is displayed.



## 5.5.4 Email

You can configure the email settings to enable the system to send the email as a notification when there is an alarm event occurs, such as video detection and system events.

**Step 1** Select **Setting > Network > Email**.

The **Email** interface is displayed. See Figure 5-24.



Figure 5-24 Email

**Step 2** Select **Enable** to enable email function.

**Step 3** Configure parameters. For details, see Table 5-13.



Table 5-13 Email parameters description

Parameter	Description
SMTP server	Configure the address of Simple Mail Transfer Protocol. For details, see Table 5-14.
Port	Enter the port value of SMTP server. For details, see Table 5-14.
Anonymous	If <b>Anonymous</b> is selected, the sender information is not displayed when sending an email.
User Name	Enter the user name and password of SMTP server. For details, see Table 5-14.
Password	
Sender	Email address of sender.
Encryption Type	In the Encrypt list, select an encryption type from None, SSL, and TLS. For details, see Table 5-14.
Subject	You can enter no more than 63 characters in Chinese, English, and Arabic numerals.
Attachment	If <b>Attachment</b> is enabled, when an alarm takes place, the system can send alarm linked snapshots.
Receiver	Receiver's Email address. You can enter up to three email addresses separated by colons.

Parameter	Description
Sending Interval	<p>This is the interval that the system sends an email for the same type of alarm event, which means, the system does not send an email upon any alarm event. The interval ranges from 0 through 3600 seconds. 0 means that there is no interval.</p>  <p>This setting helps to avoid the large amount of emails caused by frequent alarm events.</p>
Health Mail	<p>The system can send a test email to check the connection. Select the <b>Health Mail</b> check box, and then enter the interval. The system can send a test email to check the connection after the specified interval.</p>  <p>The interval ranges from 30 minutes to 1440 minutes.</p>
Test	<p>Click <b>Test</b> to test if emails can be sent out and received as intended. If the configuration is correct, the receiver's email account will receive the test email. Before testing email, click <b>OK</b> to save the email configuration.</p>

For the configuration of major mailboxes, see Table 5-14.

Table 5-14 Common mailbox configuration parameters

Mailbox type	SMTP server	Authentication method	Port	Description
QQ	smtp.qq.com	SSL	465	<ul style="list-style-type: none"> <li>Do not select <b>None</b> for encryption.</li> <li>The mailbox must have applied SMTP service.</li> <li>The password must be an "authorized password". Both the QQ login password and email login password are invalid.</li> </ul>  <p>Obtain the authorized password when your mailbox is applying for SMTP service.</p>
		TLS	587	
163	smtp.163.com	SSL	465/994	<ul style="list-style-type: none"> <li>The mailbox must have applied "SMTP" service.</li> <li>The password must be an "authorized password". The email login password is invalid.</li> </ul>  <p>Obtain the authorized password when your mailbox is applying for SMTP service.</p>
		TLS	25	
		NONE	25	
Sina	smtp.sina.com	SSL	465	The mailbox must have applied "SMTP" service.
		NONE	25	
126	smtp.126.com	NONE	25	The mailbox must have applied "SMTP" service.

Step 4 Click **OK**.

## 5.5.5 Register

After successfully auto registered, when the device is connected into the Internet, it will report the current location to the specified server to make it easier for the client software to access to the device, and to view and monitor it.

Step 1 Select **Setting > Network > Register**.

The **Register** interface is displayed. See Figure 5-25.

Figure 5-25 Register

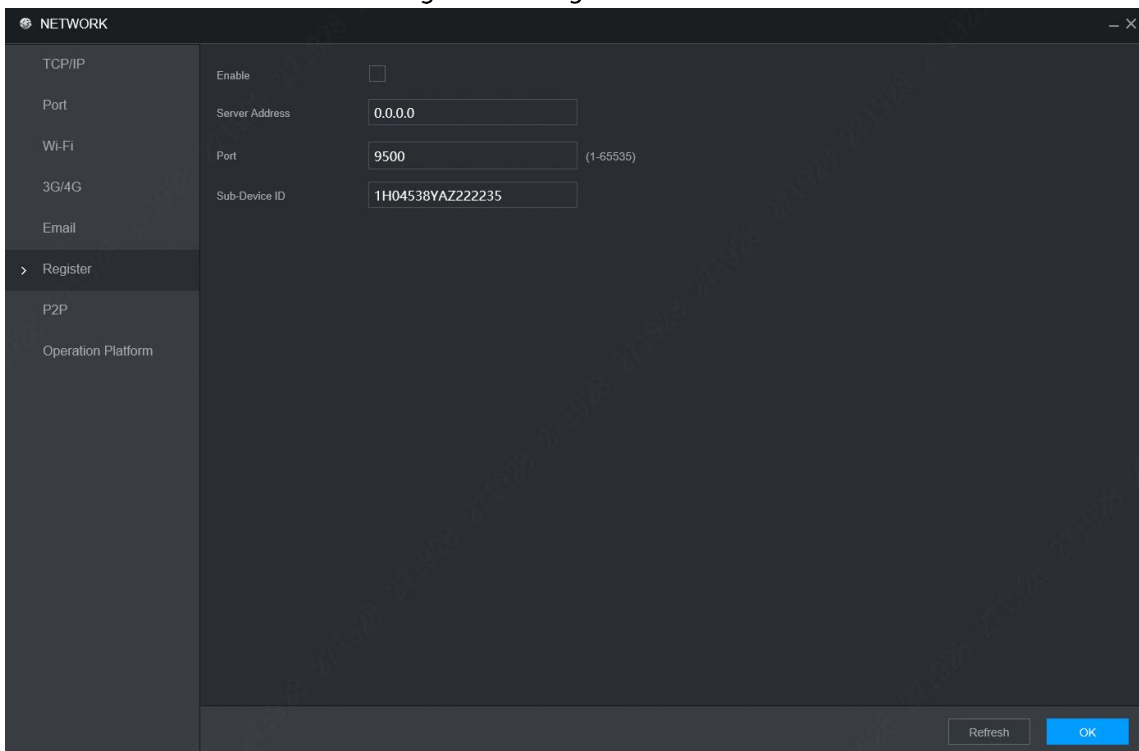

Step 2 Select the **Enable** check box. (Selected by default)

Step 3 Configure parameters. For details, see Table 5-15.

Table 5-15 Register Parameters

Parameter	Description
IP Address	Enter the IP address or domain name of the server to register.
Port	The port for auto-registration.
Sub-device ID	Unique ID for identifying the device. When different devices register to the same server, the sub-device IDs should be different.

Step 4 Click **OK**.

## 5.5.6 P2P

P2P is a private network penetration technology. With this technology, you do not need to apply for dynamic domain name, set port mapping, or deploy transit server. You can add devices for management by either of the following two ways.

- Scan the QR code on the interface to download the app, and register an account.

- Log in [www.gotop2p.com](http://www.gotop2p.com) platform to register, and then add devices by device serial number.



Before using P2P, make sure that the device is connected to the Internet.

## Prerequisites

- The device had been connected to the Internet.
- App has been downloaded and installed on the mobile phone.

## Procedure

**Step 1** Select **Setting > Network > P2P**.

The **P2P** interface is displayed, see Figure 5-26.

Figure 5-26 P2P

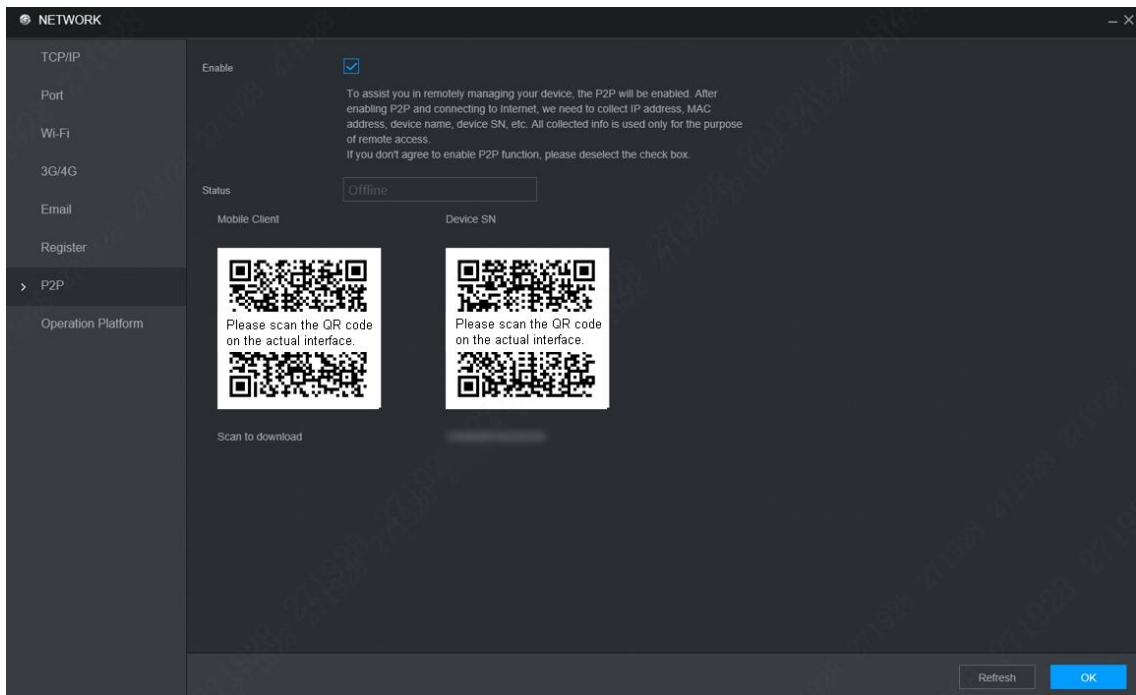

**Step 2** Select **Enable** to enable P2P.

**Step 3** Click **OK**.

The P2P registration is successful when the **Status** shows **Online**.

**Step 4** Use Mobile Client to scan the QR code under Device SN to add the device to Mobile Client.



Please scan the QR code on the actual interface of device.

## 5.6 Managing Storage Device

You can configure storage, basic information, manage HDD, and review HDD information.

## 5.6.1 Basic

On the Local interface, you can set up the strategy when the Disk is full and recording mode.

**Step 1** In the main menu, select **Setting > Storage > Basic**.

The **Basic** interface is displayed. See Figure 5-27.

Figure 5-27 Basic

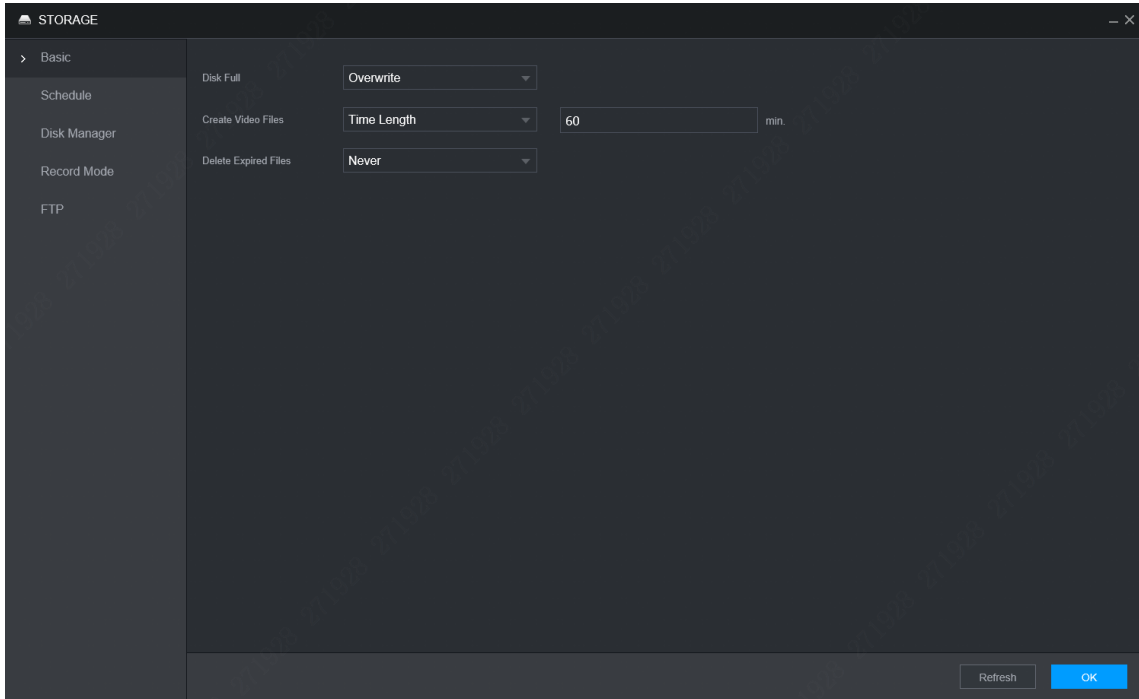

**Step 2** Configure basic information.

- Select the processing strategy of stopping recording and overwriting earlier recordings when TF Card is full.
  - ◇ **Stop:** The system stops recording when the disk is full.
  - ◇ **Overwrite:** The system overwrites the oldest files and keeps recording when the disk is full.
- Set up the time length or file size for video packaging.

Select the required packaging manner from the **Create Video Files** drop-down list. Including **Time Length** and **File Size**.

  - ◇ Set the length of time for each video file. The default value is 60 minutes, and the range is 1 minute –120 minutes.
  - ◇ Set the size of file for each video file. The default value is 1024M, and the range is 128M –2048M.
- Set the strategy of deleting old files automatically.

You can enable this function to delete recorded videos or images saved in TF card or FTP server regularly according to the time gap you have set.



After setting file auto deletion, deleted files cannot be recovered.

**Step 3** Click **OK**.

## 5.6.2 Disk Manager

Set the read and write properties of the TF card and view the capacity information of the HDD.

**Step 1** Select **Setting > Storage > Disk Manager**.

The **Disk Manager** interface is displayed. See Figure 5-28.

**Step 2** Set the read and write properties of the TF card. You can set the TF card as the Read/Write disk, Read-Only disk or Redundancy disk under the **Properties** column.

- Read/Write: You can read data from TF card and save data in TF card.
- Read-Only: You can only read data from TF card if set to read-only disk.
- Redundancy: If the device is connected to two or more TF cards, one of the TF cards can be set as the redundancy one for recording backup.



Select TF card and click **Format** to clear all data in the TF card. Proceed with caution.

Figure 5-28 Disk Manager

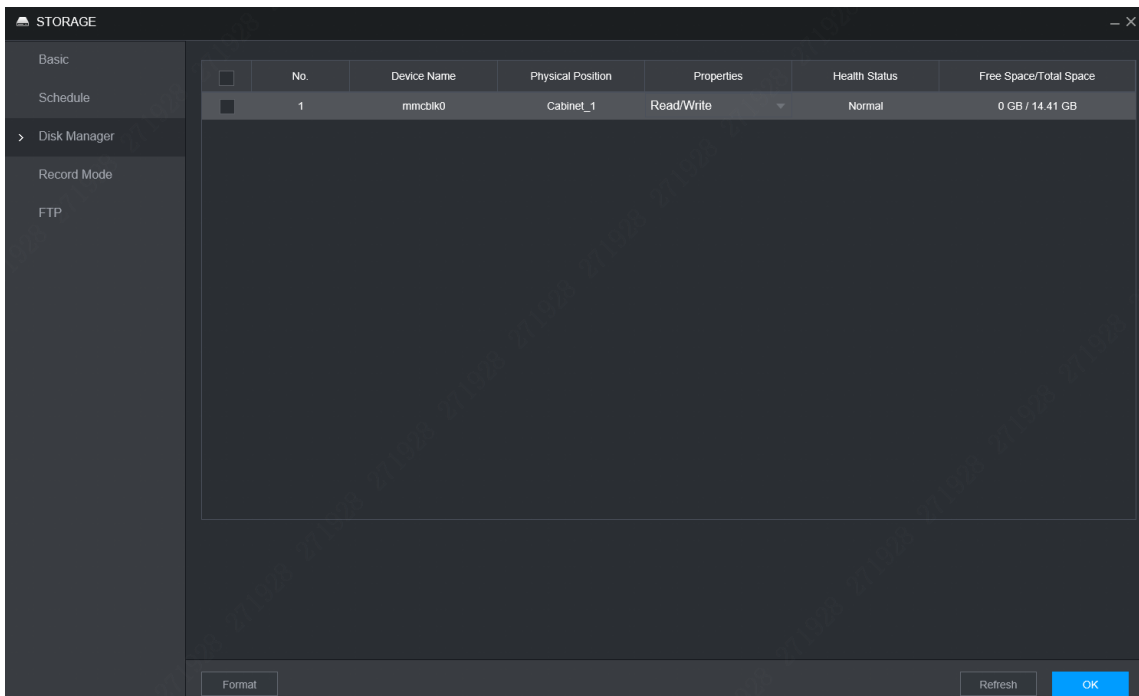

**Step 3** Click **OK**.

## 5.6.3 FTP

Configure FTP server, and then you can save videos and snapshots to the FTP server.

### Prerequisites

You have deployed a FTP server, and created a user with the read & write permission.



The created FTP user should have write permission; otherwise the upload of videos, audios, and snapshots will be failed.

## Procedure

**Step 1** Select **Setting > Storage > FTP**.

The **FTP** interface is displayed, see Figure 5-29.

Figure 5-29 FTP

**Step 2** Select **Enable** to enable FTP upload and select FTP type.



- You select FTP or SFPT from the drop-down list. SFTP is recommended to enhance network security.
- When **FTP** is selected, the system gives a risk prompt. Select **OK** or **Cancel** as needed.

**Step 3** Configure parameters. For details, see Table 5-16.

Table 5-16 FTP parameter description

Parameter	Description
Server Address	The IP address of the host PC that is installed with the FTP/SFTP server.
Port	By default, SFTP port is 22 and FTP port is 21.
User Name	The user name and password used to access the server.
Password	
Anonymous	Select <b>Anonymous</b> if you want to log in to the server anonymously.
Storage Path	Create folder on FTP server. <ul style="list-style-type: none"> <li>If you do not enter the name of remote directory, the system automatically creates the folders according to the IP, time, and channel.</li> <li>If you enter a name for the remote directory, the system creates a folder with the entered name under the FTP/SFTP root directory first, and then automatically creates folders based on IP, time, and channel.</li> </ul>

Parameter	Description
File Size	Enter the size of the uploaded recorded video. <ul style="list-style-type: none"> <li>● If the entered size is less than the recorded video size, only a section of the recorded video can be uploaded.</li> <li>● If the entered size is more than the recorded video size, the whole recorded video can be uploaded.</li> <li>● If the entered size is 0, the whole recorded video will be uploaded.</li> </ul>
Choose channel	Select the channel that you want to apply the FTP settings.
Weekday	Select the week day and set the time period that you want to upload the recorded files. You can set two periods for each week.
Period	Select the record type (Alarm, MD, and General) that you want to upload. After selecting the corresponding recording type next to the corresponding period, the selected recording type will be uploaded during the configured period.
Picture Upload Interval	<ul style="list-style-type: none"> <li>● When the <b>Snapshot Type</b> is <b>Schedule</b>, the upload method should be determined based on the image upload interval and snapshot interval.                             <ul style="list-style-type: none"> <li>◇ If this interval is longer than snapshot interval, the system uploads the most recent snapshot. For example, if the interval is 5 seconds and snapshot interval is 2 seconds, the system sends an upload command to upload the next snapshot every 5 seconds.</li> <li>◇ If this interval is shorter than snapshot interval, the system uploads the snapshot per the snapshot interval. For example, if the interval is 5 seconds and snapshot interval is 10 seconds, the system uploads the snapshot every 10 seconds.</li> </ul> </li> <li>● When the <b>Snapshot Type</b> is <b>Event</b>, the system uploads the snapshot as per the snapshot interval.</li> </ul>  <p>You can change the <b>Interval</b> and <b>Type</b>. For details, see "5.4.2.2 Snapshot".</p>

Step 4 Click **Test** to test if the FTP/SFTP server is successfully configured.

- The system pops up a message to indicate success or failure.
- If failed, please check the network connection or configurations.

Step 5 Click **OK**.

## 5.7 Configuring System

You can configure system information, including serial port, security, and vehicle information.

### 5.7.1 Configuring Serial Port Parameters

You can configure the RS-232 serial port parameters such as baud rate, data bit, stop bit, and parity.

Step 1 Select **Setting > System > Serial Port**.

The **Serial Port** interface is displayed. See Figure 5-30.



Figure 5-30 Serial Port

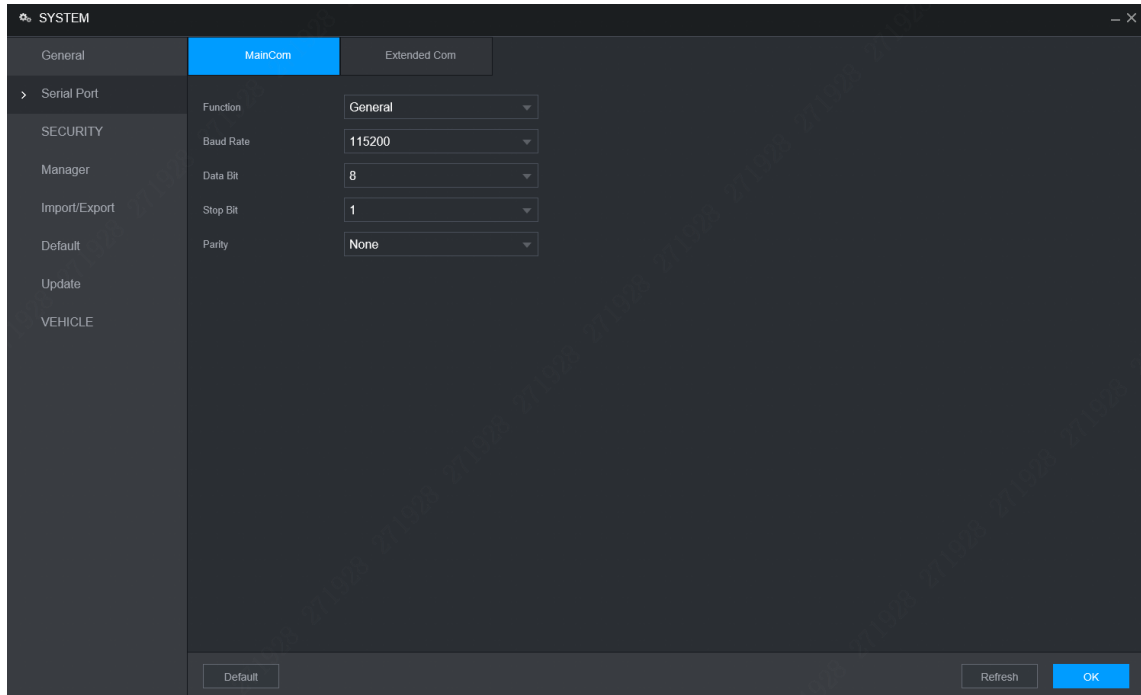

**Step 2** Configure parameters. For details, see Table 5-17.

Table 5-17 Serial port setting parameters description

Parameter	Description
Function	Select the corresponding protocol. <ul style="list-style-type: none"> <li>Console: Upgrades programs and debug by suing the serial interface and mini terminal software.</li> <li>GPS: Used to transmit real-time GPS data.</li> </ul>
Baudrate	The times of signal changes on the transmission line in time unit. <ul style="list-style-type: none"> <li>The default baud rate is 115200 for a console.</li> <li>The default baud rate is 9600 for a transparent serial port.</li> </ul>
Data Bit	Select a data bit. The options include <b>5, 6, 7, and 8</b> .
Stop Bit	Select a stop bit. The options includes <b>1, 1.5, and 2</b> .
Test	Select a parity mode from None, Odd, Even, Mark, and Null. The default is <b>None</b> .

**Step 3** Click **OK**.

## 5.7.2 Managing Security

It is to set security strategy to guarantee device network and data safety. It includes setting host IP access right and enabling system service, etc.

### 5.7.2.1 System Service

The corresponding service can only be used after the system service is turned on.

**Step 1** Select **Setting > System > Security > System Service**.

The **System Service** interface is displayed. See Figure 5-31.

Figure 5-31 System service

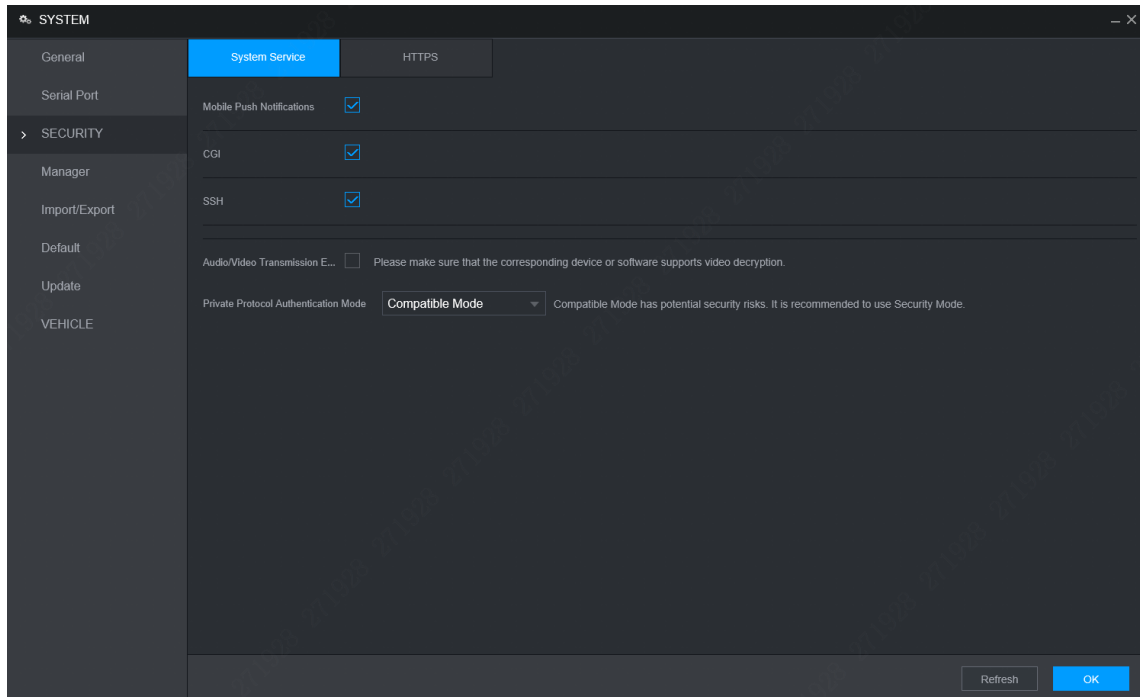

**Step 2** Select whether to enable mobile phone push, CGI, SSH, or audio/video transmission encryption as needed.

- App can receive alarm push only when the mobile phone push is enabled and the app has subscribed alarm.
- After enabling CGI, a third-party platform can connect to this device via the CGI protocol.
- When audio/video transmission encryption is enabled, audio/video transmission will be encrypted. Related devices or software shall support video decryption.

**Step 3** Click **OK**.

## 5.7.3 Configuring Vehicle Info

You can set the vehicle speed ratio and position report.

### 5.7.3.1 Configuring Speed

**Step 1** Select **Setting > System > Vehicle > Speed**.

The **Speed** interface is displayed. See Figure 5-32.

Figure 5-32 Speed

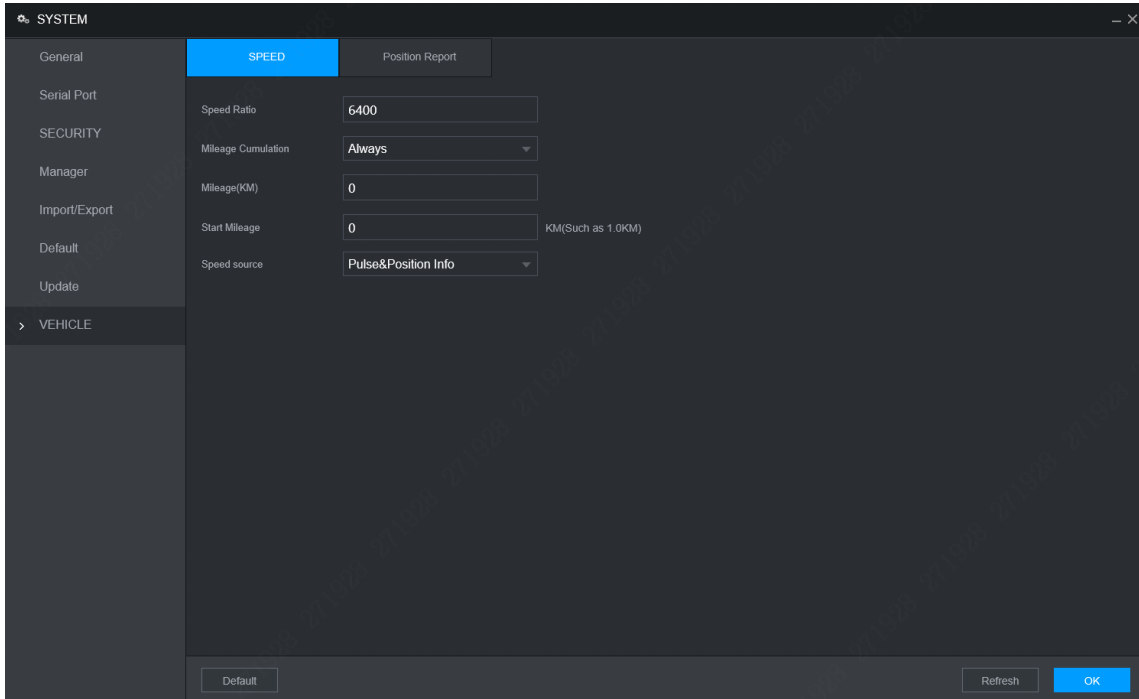

**Step 2** Configure parameters. For details, see Table 5-18.

Table 5-18 Speed parameters description

Parameter	Description
Speed Ratio	The parameter for converting speed.
Mileage Cumulation	Select the vehicle mileage cumulation mode.
Mileage	Displays the total mileage.
Start Mileage	Enter the initial mileage of the vehicle.
Speed source	Select where the speed is obtained, including <b>Pulse</b> , <b>Position Info</b> , and <b>Pulse&amp;Position Info</b> . <ul style="list-style-type: none"> <li>● Pulse: Get the speed information from vehicle pulse system.</li> <li>● Position Info: Get the speed information from positioning system.</li> <li>● Pulse&amp;Position Info: Gets the speed information from both the pulse system and positioning system. Information from the pulse system is used first.</li> </ul>

**Step 3** Click **OK**.

### 5.7.3.2 Configuring Position Report

You can configure the position report strategy to be device auto report or report per platform schedule.

**Step 1** Select **Setting > System > Vehicle > Position Report**.

The **Position Report** interface is displayed. See Figure 5-33.

**Step 2** Configure the report strategy.

- Device auto report.
  1. In the **Report Strategy** list, select **Device Auto**.  
The **Device Auto** setting interface is displayed. See Figure 5-33.

Figure 5-33 Position report (device auto)

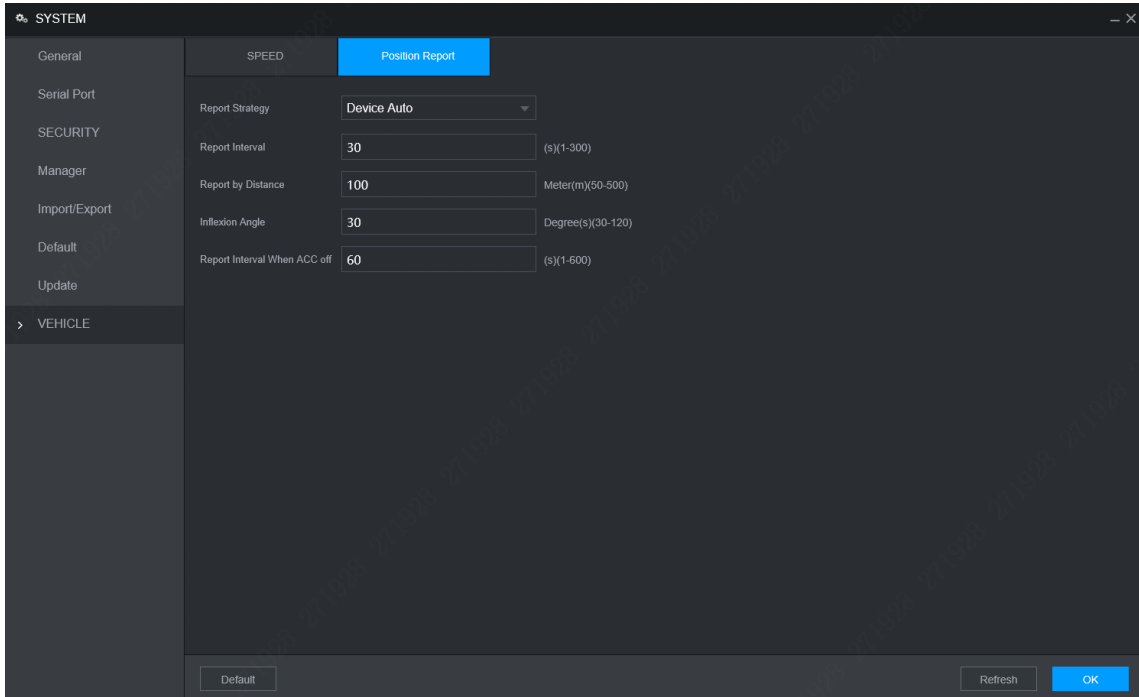

2. Configure parameters. For details, see Table 5-19.

Table 5-19 Device auto report parameters description

Parameter	Description
Report Interval	When the vehicle ACC status is on, the system report the position to platform according to the configured report interval, report distance, and inflexion angle.
Report by Distance	
Inflexion Angle	
Report Interval When ACC off	When the vehicle ACC status is off, the system report the position to platform according to the configured report interval.

- Platform schedule.

In the **Report Strategy** list, select **Platform Schedule**. The **Platform Schedule** setting interface is displayed. See Figure 5-34.

The platform obtains the device position by the configured schedule. The schedule is configured at the platform. See the user's manual for the platform.

Figure 5-34 Position report (platform schedule)

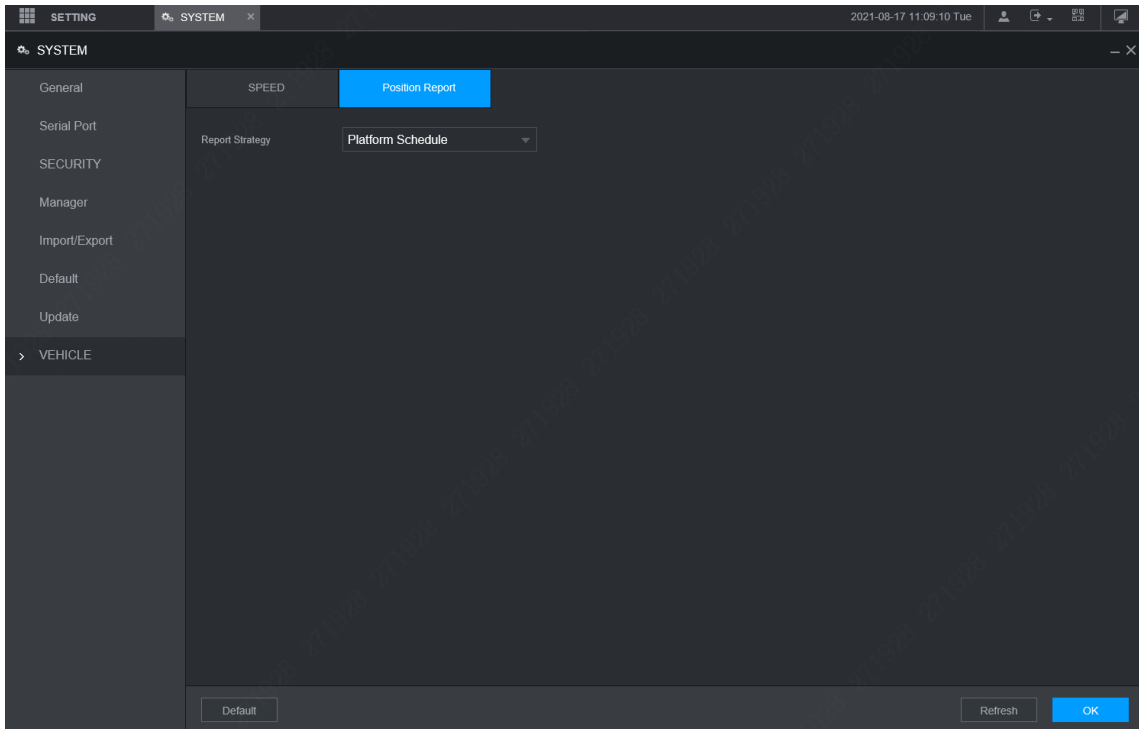

Step 3 Click **OK**.

## 5.8 Managing User Account

You can add, modify and delete user accounts and groups, and configure security questions for admin account.

### The Default User and Authority

The default user account is admin.

- The admin account is defined as the highly privileged user by default.
- To manage user accounts easily, when defining the user account authority, it is recommended to give lower authority to common user accounts than advanced user account.

### About User and User Group

You can manage the account by user and user group, and the name cannot be repeated.

- You can set maximum 64 users and 20 groups.
- The default group name by "User" and "Admin" cannot be deleted.
- Select the authorities to the user of a group. However, the authorities of the admin account cannot be specified at your will.
- Every user must belong to only one group. When selecting a group for a user, permissions of the user can only be a subset of group permissions and cannot exceed permission attributes of the group.
- Both the user name and group name support 1–31 characters and can only consist of letter, number, underline (\_), and hyphen (-).

## 5.8.1 Managing User

You can add, delete, or modify user, and set the authorities for the user of a group.

### Adding a user

**Step 1** Select **Setting > Account > Account > User**.

The **User** interface is displayed. See Figure 5-35.

Figure 5-35 User

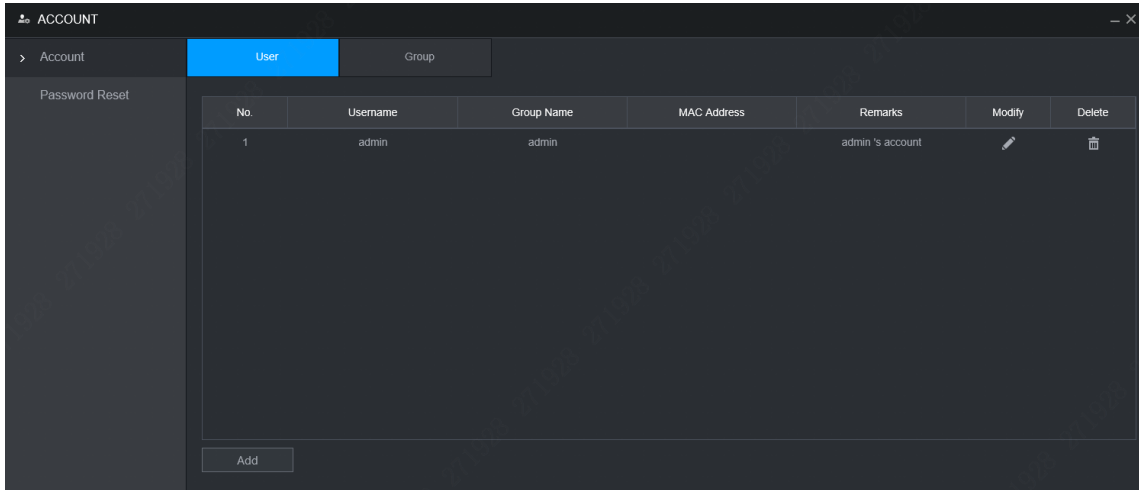

**Step 2** Click **Add**.

The **Add** interface is displayed. See Figure 5-36.

Figure 5-36 Add

Username:

Password:

Confirm Password:

Group:

User MAC:

Remarks:

Period:

Permission

All

ACCOUNT     SYSTEM     SYSTEM INFO

MANUAL CONTROL     STORAGE     EVENT

OK    Cancel

**Step 3** Configure parameters. For details, see Table 5-20.

Table 5-20 Parameters description for adding user

Parameter	Description
User Name	Enter the user name and password, and confirm the password.
Password	
Confirm Password	
Group	Select the group that the users belong to.
User MAC	Enter user MAC address that is allowed to login the device.
Remarks	Enter a description of the user.
Period	Click <b>Setting</b> to set a valid period. The user is only allowed to log in to the device in the set period.

**Step 4** Click **System**, **Search**, or **Live** to set up user permissions.



- Select **All** to select all authorities in the category.
- The authorities of the admin account cannot be changed.

**Step 5** Click **OK**.



Click to modify user information; click to delete the user.

## Changing Password

**Step 1** On the **User** interface, click .

The **Modify** interface is displayed. See Figure 5-37.

Figure 5-37 Modify

**Step 2** Select the **Modify Password** check box, and then enter old password, new password, and confirm password in the corresponding box.

**Step 3** Select the authority, including system, search, and live authorities.

**Step 4** Click **OK**.



- The new password can be set from 8 characters through 32 characters and contains at least two types from number, letter and special characters (excluding ' " \ ; & ). Please enter a strong password according to the password strength indication.
- A user authorized to manage user accounts can modify its own password and the passwords of other users.

## 5.8.2 Managing Group

You can perform the operations to manage the group account, such as adding a group, deleting a group, and modifying a group.

**Step 1** Select **Setting > Account > Account > Group**.

The **Group** interface is displayed, see Figure 5-38.

Figure 5-38 Group

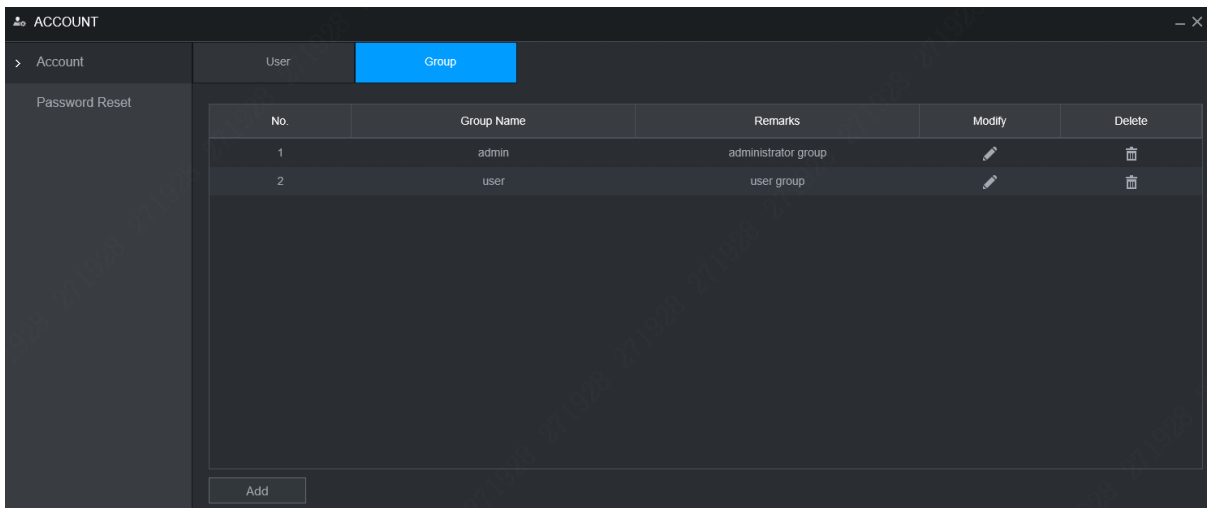

**Step 2** Click **Add**.

The **Add** interface is displayed. See Figure 5-39.

Figure 5-39 Add

Group Name:

Remarks:

Permission

**System** | Search | Live

- All
- ACCOUNT
- MANUAL CONTROL
- NETWORK
- BACKUP
- SYSTEM
- STORAGE
- CAMERA
- MAINTENANCE
- SYSTEM INFO
- EVENT
- SECURITY

OK Cancel



**Step 3** Set group name and remarks.

A group name consists of letters, numbers, and special characters (including "\_", "@", ".").



**Step 4** Select the authority, including system, search, and live authorities.



Select **All** to select all authorities in the category.

**Step 5** Click **OK**.



Click  to modify the corresponding group information; click  to delete the group.

## 5.8.3 Resetting Password

You can reset the password through the reserved phone number when you forget the login password of admin.

**Step 1** Open a browser and login the WEB interface of device.

The **Login** interface is displayed. See Figure 5-40.

Figure 5-40 Login

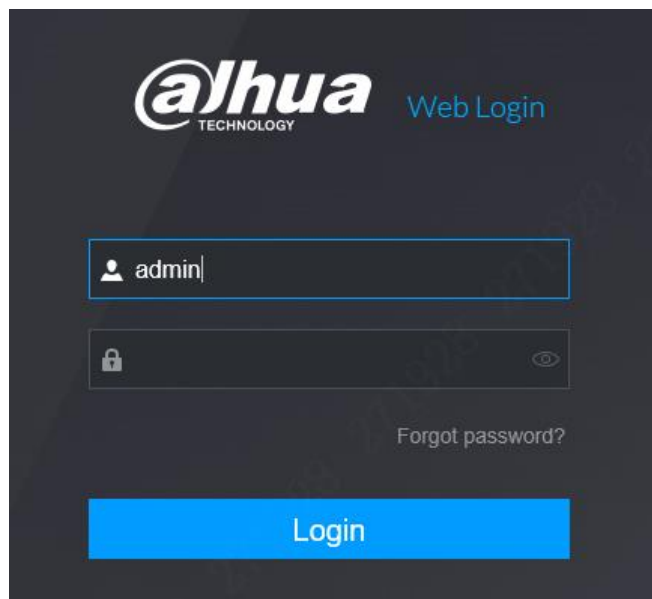

**Step 2** Click **Forgot password?**

The **Password Reset** interface is displayed. See Figure 5-41

Figure 5-41 Password Reset (1)

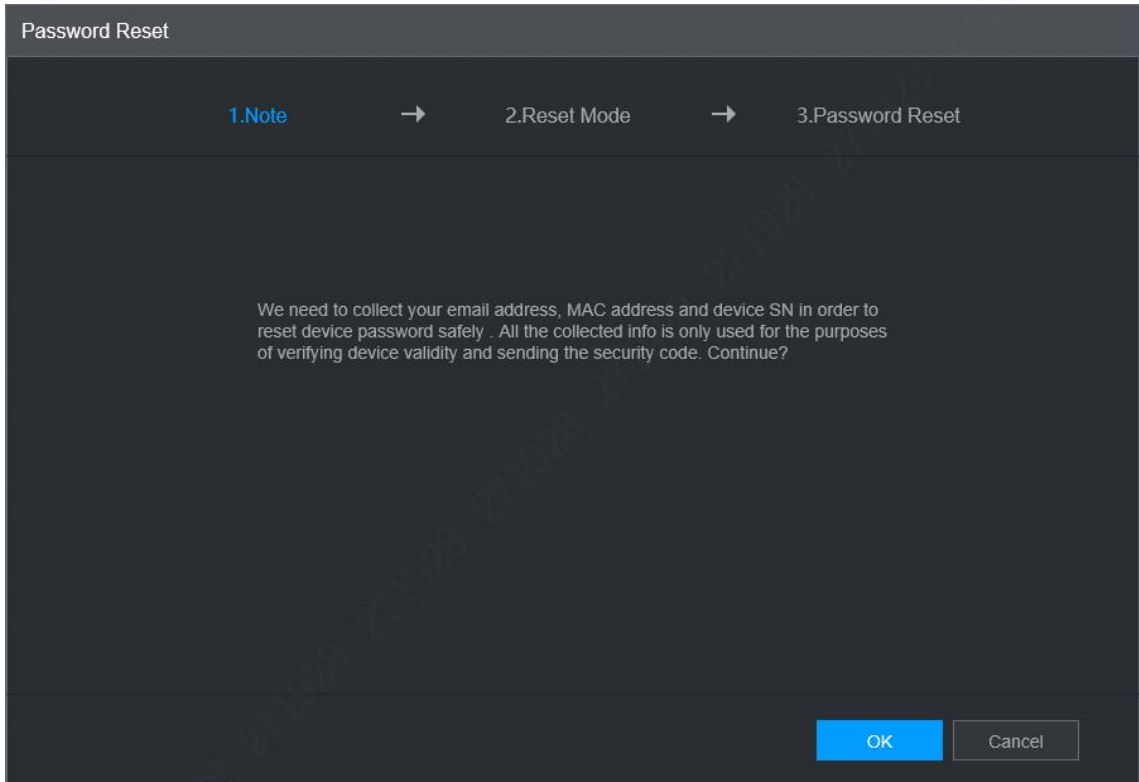

**Step 3** Click **OK**.

The **Password Reset** is displayed. See Figure 5-42.

Figure 5-42 Password Reset (2)

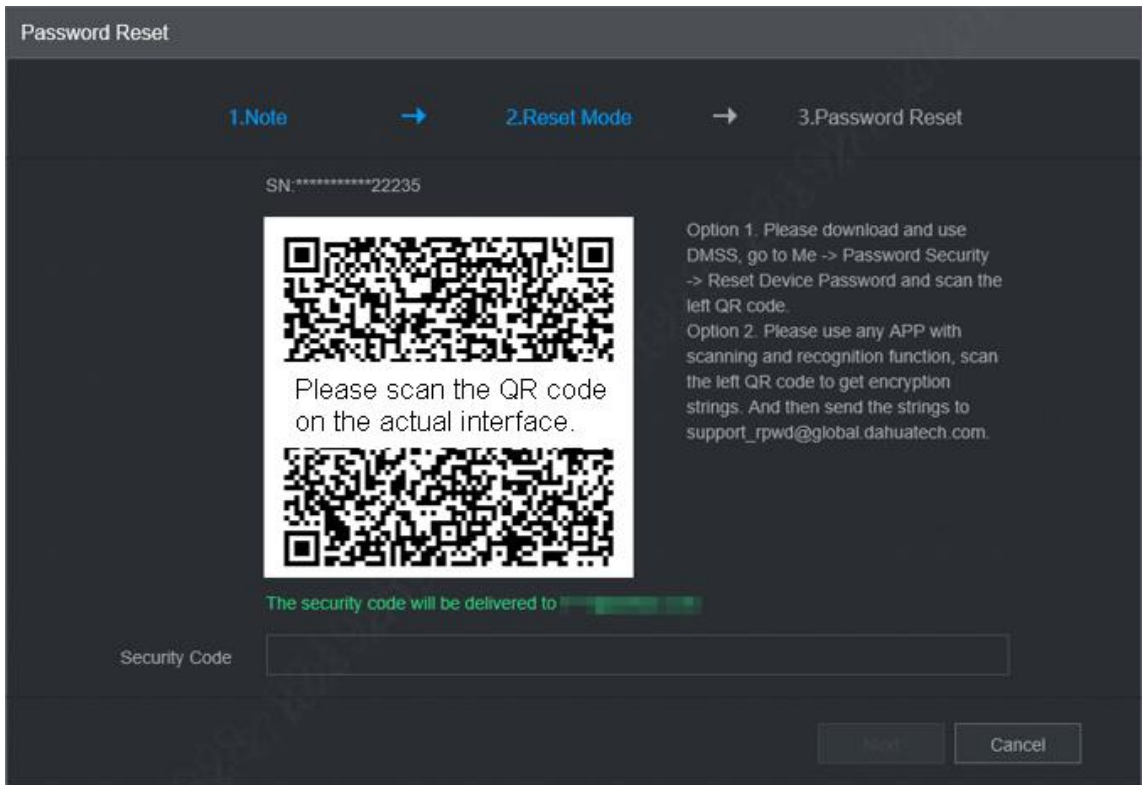

**Step 4** Follow the onscreen instructions to scan the QR code and get the security code.



- Please scan the QR code on the actual interface of device.

- At most two security codes will be generated by scanning the same QR code. To get more security code, refresh the QR code.
- Please use the security code within 24 hours after you receive it. Otherwise, it will become invalid.
- Wrong security code entered for up to five times will cause account locked for 5 min.

**Step 5** In the **Security Code** box, enter the security code received in your provided mailbox.

**Step 6** Click **Next**.

The new password setting interface is displayed. See Figure 5-43.

Figure 5-43 New password setting

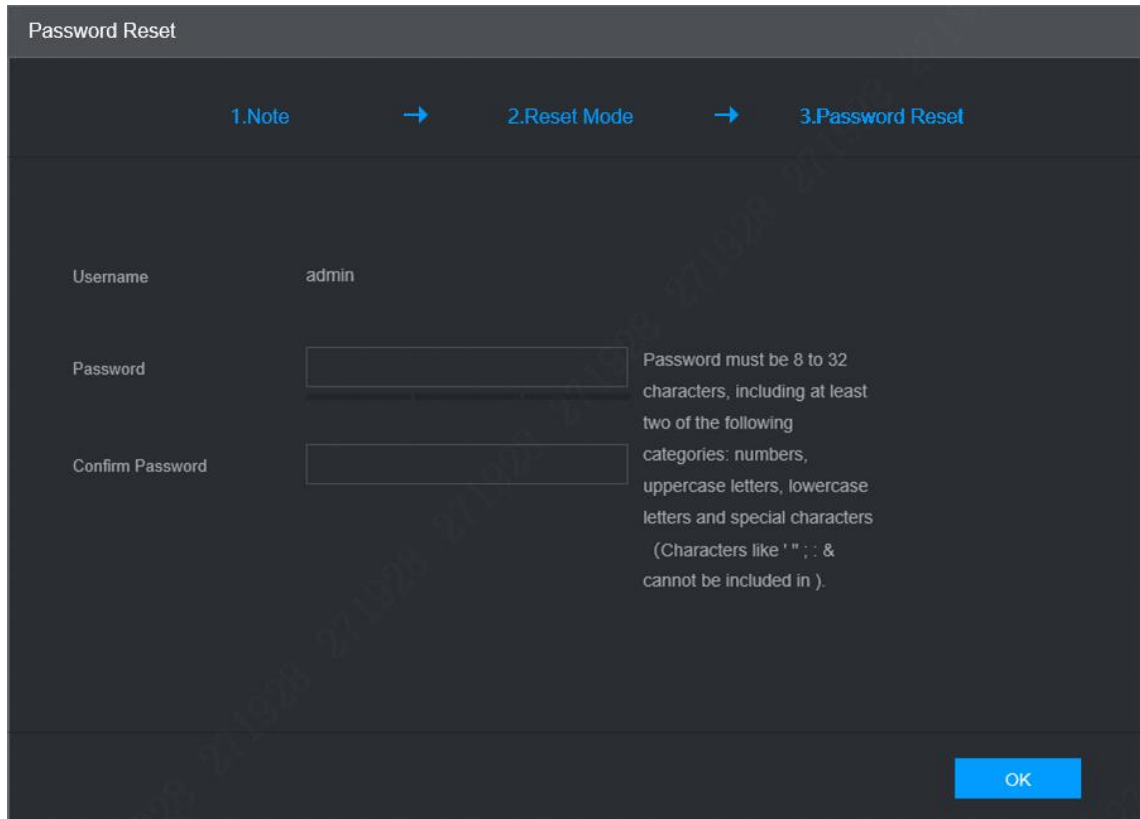

**Step 7** Reset and confirm the password.

The new password can be set from 8 through 32 non-empty characters and contains at least two types from number, letter and special characters (excluding "", "", "", ":", and "&"). Please enter a strong password according to the password strength indication.

**Step 8** Click **OK**.

The system prompts successful operation and restarts. You can use the new password to log in to the device.

# 6 Update

## 6.1 System Version

You can view the device hardware characteristics, version such information.

Select **Setting > System Info > Version**.

The **Version** interface is displayed. See Figure 6-1.

Figure 6-1 Version

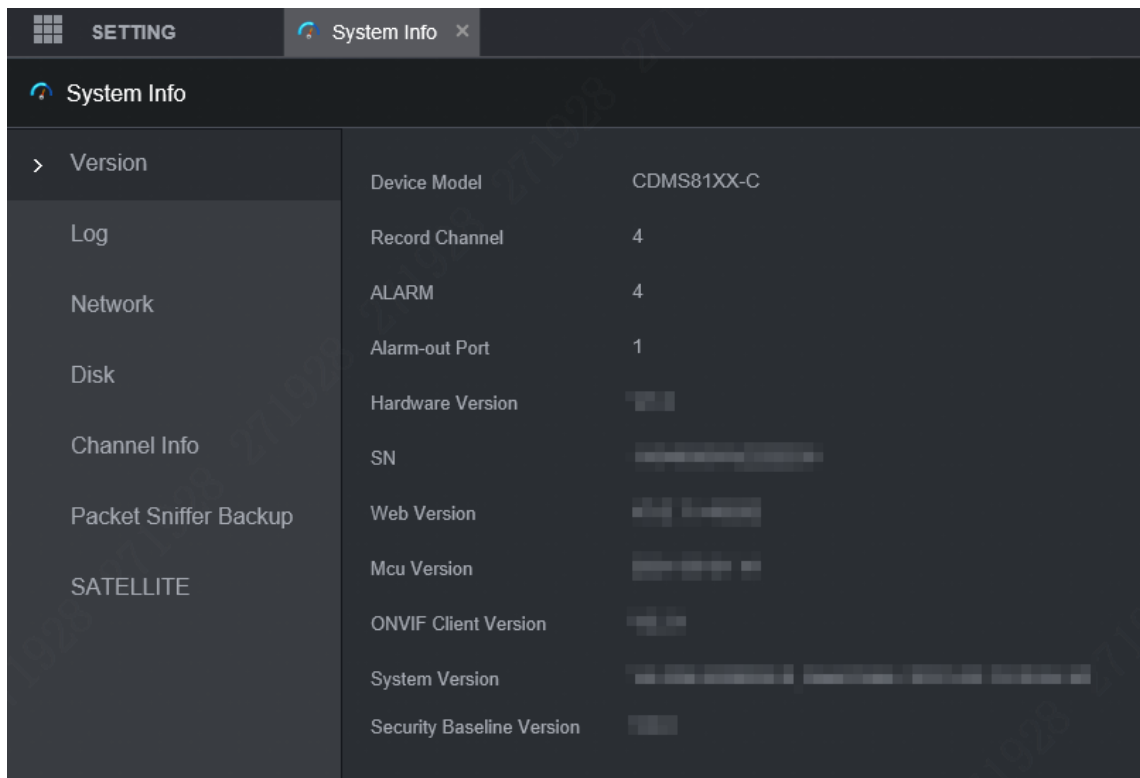

## 6.2 Update

Import the update file in the format of .bin to update the system.



- Do not disconnect the power or network, or restart or shut down the device during update cannot be used.
- Incorrect update programs may result in the device unable to work.

**Step 1** Select **Setting > System > Update**.

The **Update** interface is displayed. See Figure 6-2.

Figure 6-2 Update

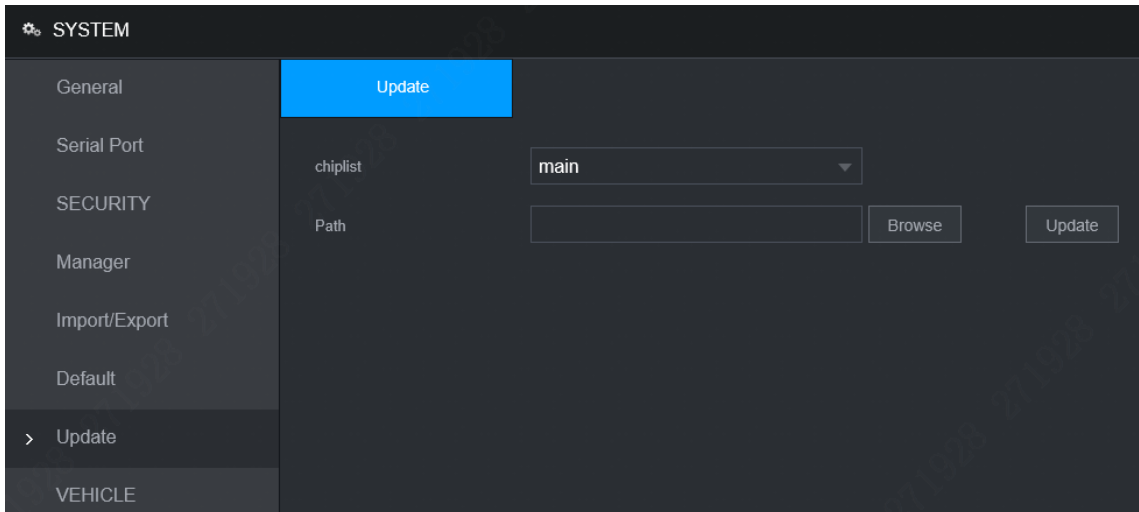

Step 2 Select the chip list that suits your actual needs.

- To update system programs, select **Main** for the chip list.
- To update the MCU firmware programs, select **MCU** for the chip list.

Step 3 Click **Browse** and select the update file you want to use.

Step 4 Click **Update**.

The system starts updating. You should login to the WEB interface again after updating.

# 7 System Maintenance

## 7.1 Requirement for Maintenance

To keep the device running normally, it is recommended to manage, backup, and maintain the device.

- Check the monitoring screen of Device regularly.
- Delete the unused user and group regularly.
- Modify the user password every three months.
- View the system logs regularly and analyze the data to handle the abnormalities timely.
- Back up the system configurations regularly.
- Reboot this device regularly.
- Upgrade firm wares regularly.

## 7.2 System Information

You can view device version information, logs, network information, HDD information, channel information, satellite information, and MAC information.



For version information, see "6.1 System Version".

### 7.2.1 Log

You can search, view, and back up the logs to local PC.

**Step 1** Select **Setting > System Info > Log**.

The **Log** interface is displayed. See Figure 7-1.

Figure 7-1 Log

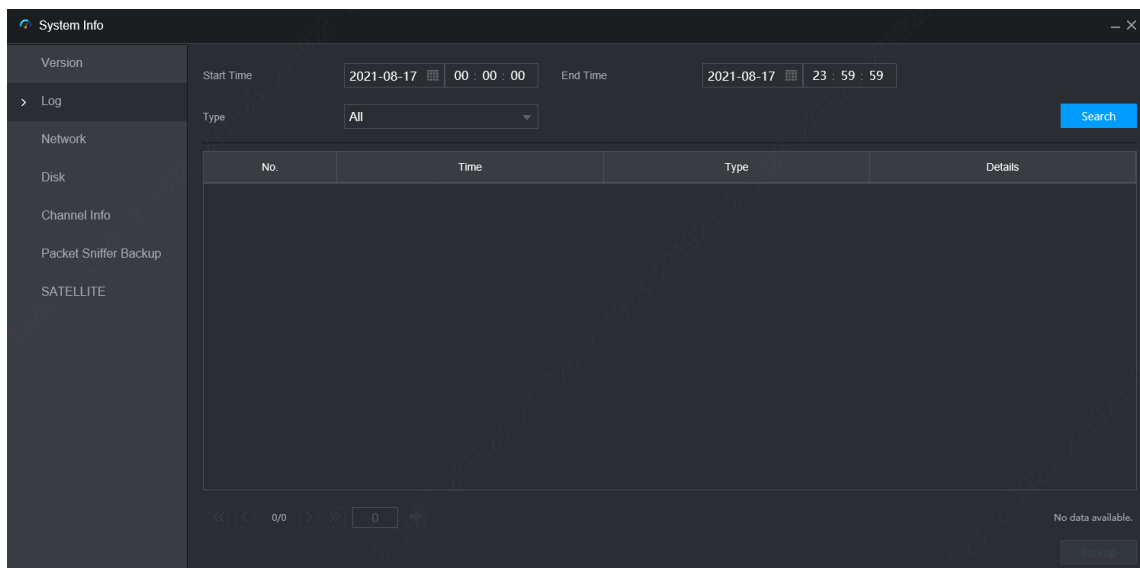

**Step 2** Set up Start Time, End Time, and Type.

**Step 3** Click **Search**.

The searched logs are displayed.



Select the log that you want to back up, and then click **Backup**. You can select the save path to save the log to PC.

## 7.2.2 Network Info

You can view IP information of the logged in device.

**Step 1** Select **Setting > System Info > Network**. The **Network** interface is displayed. See Figure 7-2.

**Step 2** Click **Refresh** and the latest network information is displayed.

Figure 7-2 Network

No.	Username	Group Name	IP Address	User Login Time
1	admin	admin	192.168.1.1	2021-08-17 13:35:44
2	admin	admin	192.168.1.1	2021-08-17 13:35:45

## 7.2.3 Disk

You can view the disk information of the device, including device name, physical position, health status, and free space.

Select **Setting > System Info > Disk**. The **Disk** interface is displayed. See Figure 7-3.

Figure 7-3 Disk

No.	Device Name	Physical Position	Health Status	Free Space/Total Space	S.M.A.R.T
1*	mmcblk0	Cabinet_1	Normal	0 GB / 14.41 GB	

Record Time Refresh

## 7.2.4 Channel Info

You can view the channel information.

Select **Setting > System Info > Channel Info**. The **Channel Info** interface is displayed. See Figure 7-4.

Figure 7-4 Channel Info

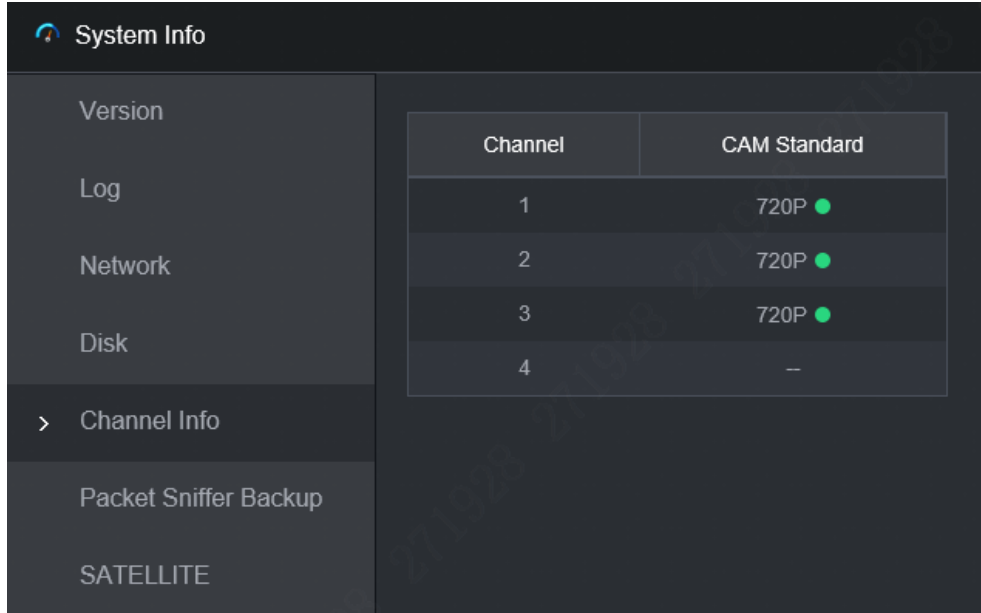

Channel	CAM Standard
1	720P ●
2	720P ●
3	720P ●
4	—

## 7.2.5 Satellite Info

You can view the satellite positioning information such as module status, positioning status, latitude and longitude, and search results.

Select **Setting > System Info > Satellite**. The **Satellite** interface is displayed. See Figure 7-5.

Click **Refresh** and the latest satellite information is displayed.



- If the GPS module status indicates normal and does not position within five minutes, the GPS module automatically resets and re-positions. When the positioning information is obtained again, the GPS module reset times is up to 20, or the device is restarted, you can view the GPS module reset records in the log.
- When the GPS module is short-circuited for more than 10 seconds, the module status is abnormal and the GPS module is automatically powered off and no longer powered on. After the device is restarted, the GPS module will be powered on again.



Figure 7-5 Satellite



## 7.3 Automatic Maintenance

You can configure the automatic maintenance settings such as auto reboot, auto deleting old files, auto booting up, auto shutdown, and delay for auto shutdown.

### 7.3.1 Auto Reboot

Once the device is running for a long time, you can set to automatically reboot the device at idle time. After configuring auto reboot, when the device is working, it reboots according to the schedule.

**Step 1** Select **Setting > System > Manager**.

The **Manager** interface is displayed. See Figure 7-6.

Figure 7-6 Manager

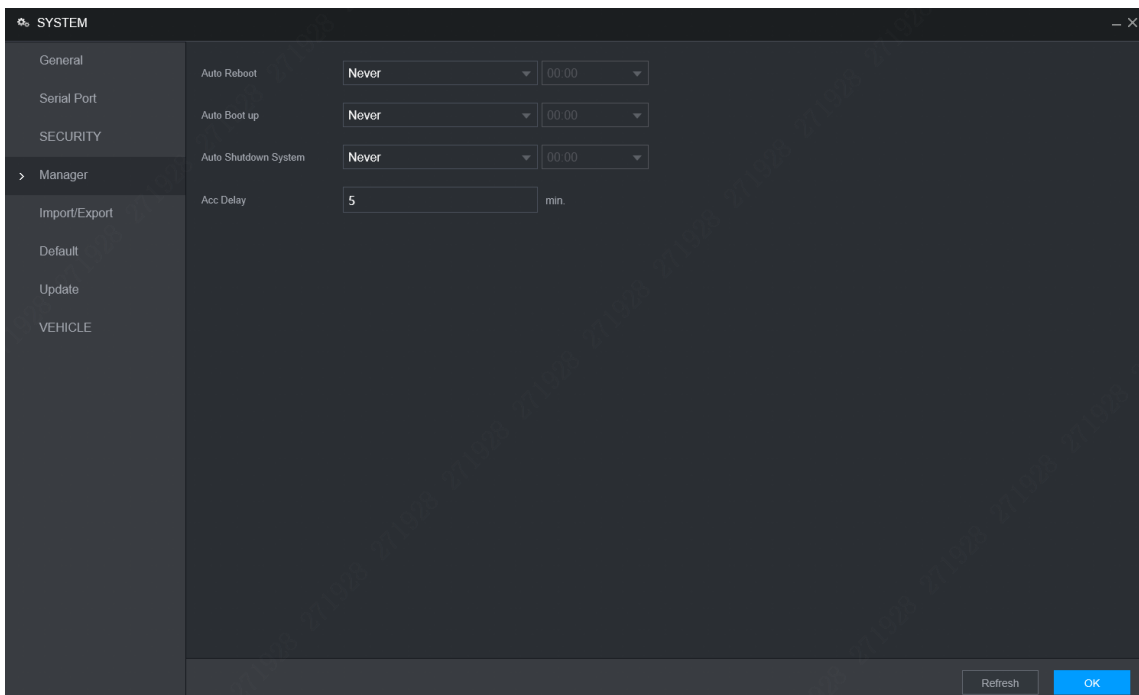

**Step 2** Select the strategy of auto restart.

- Select **Never**, and the device will never restart automatically.

- Select **Every Day**, set the device restart time, and the device will restart automatically at that time point.
- Select **Monday** to **Sunday**, set the device restart time, and the device will restart automatically at that time point every week. If **Sunday** and **01:00** are selected, the device will restart automatically at 1:00 every Sunday.

Step 3 Click **OK**.

## 7.3.2 Auto Boot up

After configuring auto start, the device starts automatically at the scheduled time point. If you turn the vehicle key to ACC before the configured auto start time, the device starts immediately. When the documentation is powered off, the device will shut down as per the scheduled auto delay for shutdown.

Step 1 Select **Setting > System > Manager**.

The **Manager** interface is displayed.

Step 2 Select the strategy of auto start.

- Select **Never**, and the device will never start automatically.
- Select **Every Day** and set the time. When you turn the vehicle key to ACC before this time point, the device starts immediately.

Step 3 Click **OK**.

## 7.3.3 Auto Shutdown System

After configuring auto shutdown, the device automatically shuts down according to the ACC power off time and auto boot up setting.

- If you have set the time for auto start, there are two situations when the ACC is powered off: If the system time is between the auto start time and auto shutdown time, the device is turned off at the configured time point. If the system time is before the auto start time or after the auto shutdown time, the device is turned off immediately.
- If the auto booting up is not set, when the ACC is disconnected, the Device shuts down at the scheduled time.

Step 1 Select **Setting > System > Manager**.

The **Manager** interface is displayed.

Step 2 Select the strategy of auto shutdown.

- Select **Never**, and the device will never shut down automatically.
- Select **Every Day** and set the time. The system will shut down as per the ACC power off time and auto start setting.
- Select **Every Day** for **Auto Shutdown**, and then enter the specific time.

Step 3 Click **OK**.

## 7.3.4 Acc Delay

After configuring delay for auto shutdown, when ACC is disconnected, the device shuts down as per the settings of delay for auto shutdown.

- If you enter a delay value that is not 0, the device automatically shuts down after the preset delay.
- If you enter 0, the device shuts down as per the auto shutdown settings without delay.

**Step 1** Select **Setting > System > Manager**.

The **Manager** interface is displayed.

**Step 2** Configure the ACC delay for shutdown.

The value ranges from 0 through 65535. The fault value is 5.

**Step 3** Click **OK**.

## 7.4 Backup and Restore

You can back up or restore the web configurations and restore to default settings.

### 7.4.1 Backing up Configurations

You can back up all the configurations of web.

**Step 1** Select **Setting > System > Import/Export**.

The **Import/Export** interface is displayed. See Figure 7-7.

Figure 7-7 Import/Export (1)

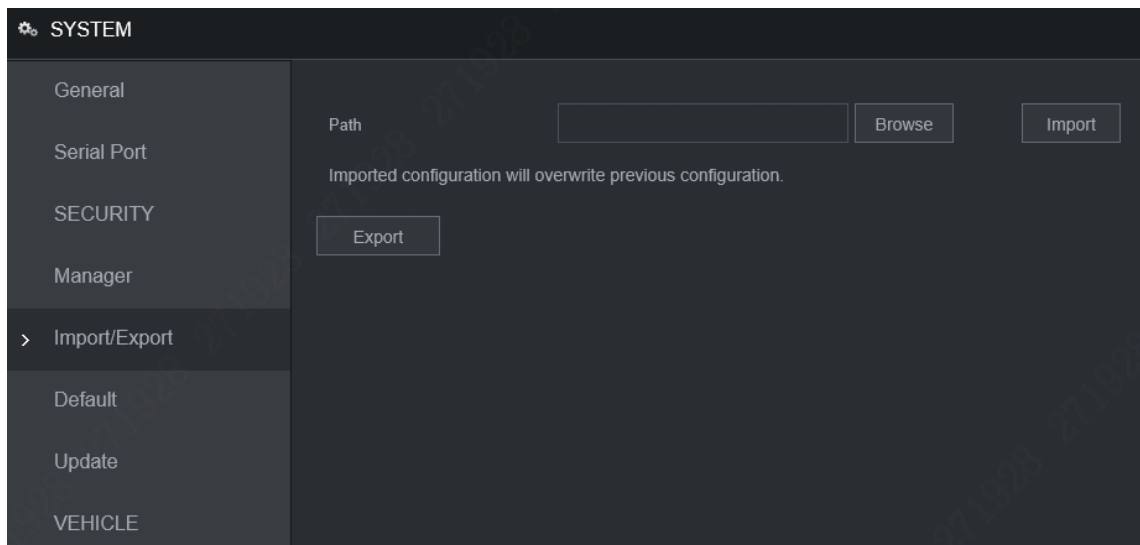

**Step 2** Click **Export**, and select the backup path.

The system starts backing up configurations.

### 7.4.2 Importing Configurations

You can use the backed up configurations to quickly configure the device and restore the device configurations.

**Step 1** Select **Setting > System > Import/Export**.

The **Import/Export** interface is displayed. See Figure 7-8.

Figure 7-8 Import/Export (2)

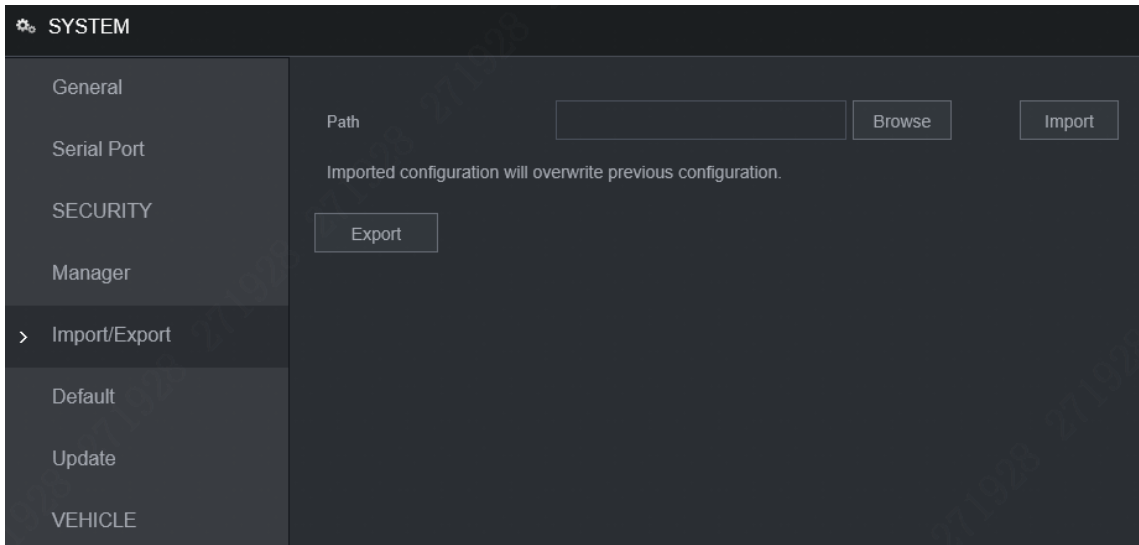

**Step 2** Click **Browse**, and then select the backup file you want to import.

**Step 3** Click **Import**.

The system pops up the reboot message. Click **OK**, the system starts importing the configurations and reboot the device after importing is completed.

### 7.4.3 Restoring to Default

You can restore the system to default configurations or the factory default. Only the user with the default & upgrade authorities can do this.



The corresponding functions will be restored to the factory settings, and your current configurations will be lost. Proceed with caution.

**Step 1** Select **Setting > System > Default**.

The **Default** interface is displayed. See Figure 7-9.

Figure 7-9 Default

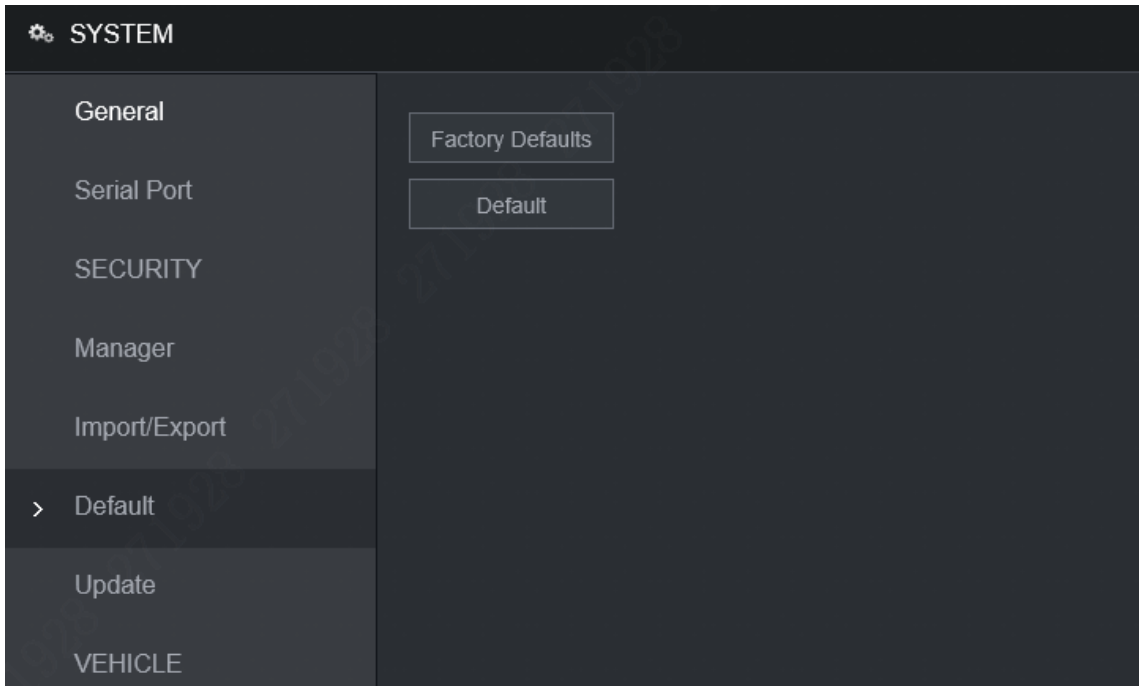

**Step 2** Select the check box of the options that you want to restore to the factory default.

- **Default:** Click **Default**, and the **Reboot** dialog box is popped up. See Figure 7-10. Then click **OK**. All configurations other than user name, password, security questions and device IP are restored to the default configuration of the device.
- **Factory Default:** Click **Factory Default**, and the **Reboot** dialog box is displayed. See Figure 7-11. Then click **OK**, and the system restarts. After the device is restarted, the system will restore to factory defaults, and the device requires initialization again. Proceed with caution.

When there is a user operating on the local interface, the factory default settings cannot be performed until the local user log out.

Figure 7-10 Reboot (1)

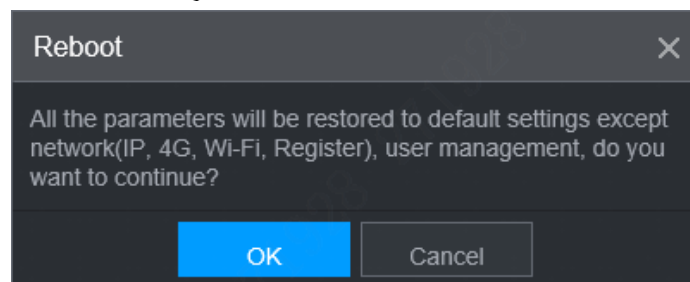
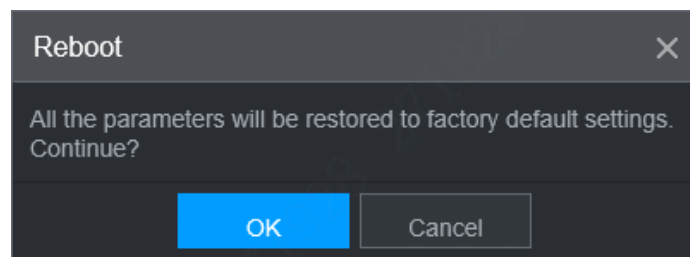

Figure 7-11 Reboot (2)



## 7.5 Network Sniffer

The packet data can be provided to the developers or engineers to analyze the network usage status.

### Prerequisites

The device being captured is connected to an external backup device.

### Procedure

**Step 1** Select **Setting > Info > Packet Sniffer Backup**.

The **Packet Sniffer Backup** interface is displayed, see Figure 7-12.

Figure 7-12 Packet Sniffer Backup  
Packet Sniffer Backup

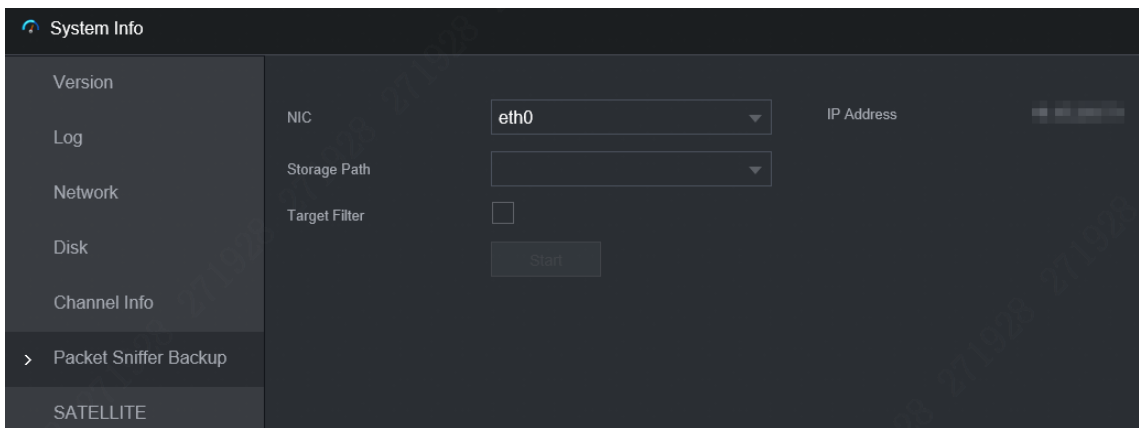

**Step 2** Select the Ethernet card and save path.

**Step 3** Select the **Target Filter** check box, and then enter the IP address that you want to filter.

**Step 4** Click **Start**.

The system starts the sniffer, and the data will be stored to the external backup device.

**Step 5** Click **Stop**.

The **Message** dialog box is displayed, see Figure 7-13.

Figure 7-13 Message

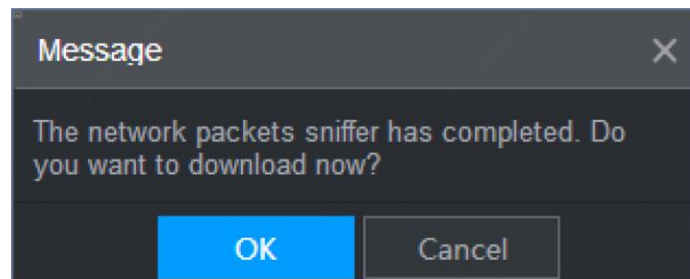

**Step 6** Click **OK** or **Cancel** to complete the task.

- Click **OK** to download the files locally, which can be viewed in the storage path.
- Click **Cancel** to stop downloading.

## 8 Logging in to the Device from DSS

Beside from WEB, you can also remotely login the device from Digital Surveillance System (DSS)  
For details, see the manual of DSS.

## Appendix 1 FAQ

If your questions are not solved by following the answers in this document, contact your local customer service or call customer service at headquarters. We will guide you to solve your problems.

**1) Q: Disconnect the constant electricity but the device is still working.**

A: Possible reasons:

The UPS setting provides constant power supply to the device when the lithium battery voltage is above 7V.

**2) Q: The device gives squeal after start.**

A: Possible reasons:

- Connecting to the display and being too close to the camera.
- A single channel interface or a large-image multi-channel interface. The first route of sound comes from a local source.

**3) Q: The interface shows that no SIM card is detected.**

A: Possible reasons:

- SIM card not inserted.
- Micro SIM card reversely inserted with its notch facing outward. Follow instructions on the label to insert the SIM card.
- SIM card is damaged.

**4) Q: DVR cannot boot up properly.**

A: Possible reasons:

- The input power is not correct; the input voltage is too low or too high.
- Poor contact in the input power cable or incorrect wiring.
- HDD is damaged or poor contact between the HDD carrier and HDD.
- Main board is damaged.

**5) Q: DVR automatically reboots or frequently crashes.**

A: Possible reasons:

- Input voltage is unstable or too low
- The Device is not properly installed, which result in poor contact between components.
- Poor heat dissipation and too many dusts result in poor working environment for the Device.
- Hardware malfunction.

**6) Q: Blank screen in a channel of the display**

A: Possible reasons:

- A camera is damaged. Replace the damaged camera.
- The connection wire is damaged. Replace the damaged connection wire.

**7) Q: There is no video output for single channel, multiple channels or all channels**

A: Possible reasons:

- Incorrect program. Upgrade the correct program.
- Image brightness is set as 0. Restore to default settings.
- Video input signal is null or too weak.
- Channel protection (or screen protection) is set.
- Hardware malfunction.



**8) Q: Real-time video image is abnormal, such as color and brightness is distorted.**

A: There are the following possibilities:

- NTSC and PAL settings are not correct, and the image becomes black and white.
- Device and monitor resistance is not compatible.
- Video network transmission distance is too far or transmission line signal attenuation is too much.
- NVR color or brightness settings are not correct.

**9) Q: I cannot search video record in local playback.**

A: There are the following possibilities:

- Poor contact between the HDD carrier and HDD.
- HDD is damaged.
- Upgraded a program different from the original program file system.
- The video record is overlapped.
- The video record is not opened.

**10) Q: The local video record is blurry.**

A: Possible reasons:

- The image quality is too low.
- Program read error, bit data is too small, and there is full of mosaic in the screen. Please firstly try to restart the DVR to solve this problem.
- HDD Error
- Hardware malfunction.

**11) Q: No audio.**

A: Possible reasons:

- It is not an active speaker.
- Audio cable is damaged.
- Hardware malfunction.

**12) Q: There is audio under monitoring state but no audio under playback state.**

A: There are the following possibilities:

- Audio function is not enabled.
- The corresponding channel does not connect to the camera. Playback is not continuous when the screen is blue.

**13) Q: The time displayed in the video record is wrong.**

A: Possible reasons:

- Error settings.
- Poor battery contact or low voltage.
- Crystal oscillator does not work.

**14) Q: USB backup error.**

A: There are the following possibilities:

- Too much data which occupies CPU resources. Please stop recording first and then begin backup.
- Backup device is not compatible.
- Backup device is damaged.
- The backup device features high power and needs separate power supply.

**15) Q: Alarm does not work.**

A: Possible reasons:

- Incorrect alarm settings.
- Incorrect alarm wiring.
- Incorrect alarm input signal.
- An alarm device is connected to 2 loops at the same time.

**16) Q: Messy channel display.**

A: Possible reasons:

- Incorrect selection of camera type. Auto switch is recommended.
- The camera is damaged.

**17) Q: Record storage period is not enough.**

A: Possible reasons:

- Low camera quality, dirty lens, camera installed against the light, or iris not properly adjusted caused large big rate.
- HDD capacity is not enough.
- The HDD is damaged.

**18) Q: No 3G/4G dial-up. No dial-up IP**

A: Possible reasons:

- Check if the SIM card is normal.
- Check if the SIM card is not in service.
- Check if the 3G/4G antenna is connected as intended.
- Check if the 3G/4G signals are strong enough.
- Try out with another SIM card.

**19) Q: 3G/4G platform is not online.**

A: Possible reasons:

- Check if 3G/4G dial-up is normal.
- Check if local active registration is correctly set up.
- Check if the sever terminal is correctly set up.

**20) Q: No GPS data.**

A: Possible reasons:

- Check if the GPS antenna is connected as intended.
- Make sure the GPS antenna is in a place where signals are not blocked.

**21) Q: GPS drifting and produces speed for no reason.**

A: Possible reasons:

Weak GPS signal.

**22) Q: Video record is silent.**

A: Possible reasons:

Check if a normal analog camera is connected. Only HDCVI camera with audio input supports audio.

## Appendix 2 Storage Capacity Calculation

When the device is installed for the first time, make sure the HDD (or TF card) is installed.

Capacity calculation formula:

Total capacity (M) = Channel quantity × Demand time length (hour) × storage capacity occupied per hour (M/hour)

Recording time calculation formula:

Recording time (hour) = 
$$\frac{\text{Total capacity (M)}}{\text{Storage capacity occupied per hour (M/hour)} \times \text{Channel quantity}}$$

The device adopts H.264/H.265 compression technology, which features a large dynamic range. Therefore, when calculating HDD capacity, you should accord to the bit rate to evaluate the file size generated per hour from each channel.

## Appendix 3 Legal Information



### Copyright

ZHEJIANG DAHUA VISION TECHNOLOGY CO., LTD. All rights reserved.

Any content of this document may not be reproduced, transmitted, distributed or stored in any form by anyone without prior written permission of Zhejiang Dahua Vision Technology Co., Ltd. (hereinafter referred to as "Dahua").

The products described in this document may contain the software that belongs to Dahua or the third party. Without the prior written approval of the corresponding party, any person cannot (including but not limited to) copy, distribute, amend, abstract, reverse compile, decode, reverse engineer, rent, transfer, sublicense the software.

### Trademarks

- , , , , and  the trademarks or registered trademarks of Dahua.
- HDMI logo, HDMI, and High-Definition Multimedia Interface are trademarks or registered trademarks of HDMI Licensing LLC. This product has been authorized by HDMI Licensing LLC to use HDMI technologies.
- VGA is the trademark of IBM.
- The Windows logo and Windows are trademarks or registered trademarks of Microsoft.
- All the company names and trademarks mentioned herein are the properties of their respective owners.

### Disclaimer

- To the maximum extent permitted by applicable laws, in no event shall we be liable for any special, incidental, indirect, or consequential damages or any damages whatsoever on, including without limitation, loss of profit, data, goodwill, files, or expected savings, arising out of or in any way connected with the relevant contents and described products in this document.
- All products described in this document are provided on an "as-is" basis. Unless required otherwise by applicable laws, this document is provided without a warranty of any kind, either express or implied, including but not limited to, merchantability, degree of satisfaction, fitness for a particular purpose, or non-infringement.

### Compliance to Export Control

Dahua complies with applicable export control laws and regulations, and requirements on export, re-export, and transfer of hardware, software, and technologies. You are supposed to fully understand and strictly comply with domestic and international laws and regulations on export control related to the products described in this document.

### Privacy Protection Notice

As the device user or data controller, you might collect personal data of others' such as face, fingerprints, car plate number, Email address, phone number, GPS and so on. You need to be in compliance with the local privacy protection laws and regulations to protect the legitimate rights and interests of other people by implementing measures include but not limited to: providing clear and visible identification to inform data subject the existence of surveillance area and providing related contact.

## About the Manual

- The Manual is for reference only. If there is inconsistency between the Manual and the actual product, the actual product shall prevail.
- We are not liable for any loss caused by the operations that do not comply with the Manual.
- The Manual would be updated according to the latest laws and regulations of related regions. For detailed information, see the paper User's Manual, CD-ROM, QR code or our official website. If there is inconsistency between paper User's Manual and the electronic version, the electronic version shall prevail.
- All the designs and software are subject to changes without prior written notice. The product updates might cause some differences between the actual product and the Manual. Please contact the customer service for the latest program and supplementary documentation.
- There still might be deviation between the actual value of some data and the value provided, if there is any doubt or dispute, please refer to our final explanation.
- Upgrade the reader software or try other mainstream reader software if the Manual (in PDF format) cannot be opened.

# Appendix 4 Cybersecurity Recommendations

## Declarations

- By connecting the product into Internet, you have to bear related risks on your own account, including but not limited to those related to cyber attacks, hacker attacks, and virus infections. It is advised to enhance the protection for your network data, device data, and personal information. We recommend you to take necessary actions to enhance the security of your devices and network, such as changing passwords and using strong passwords whenever possible, changing passwords regularly, and updating firmware to the latest version. We are not liable for any malfunction, information leak or other problems of the product caused thereby, but we will provide security services for the product against these risks.
- To the extent not explicitly prohibited by applicable laws, we, our employees, licensors, or affiliated companies are not liable for any loss of profit, revenue, sales, or data, or the cost for purchasing substitute goods or services, property loss, personal injury, business discontinuity, commercial information loss, or any special, direct, indirect, incidental, consequential, economic, covering, or punitive damages caused by using or not able to use this product or service, regardless of on which liability theory (contract, tort, fault, or others) these damages are based, even if we, our employees, licensors, or affiliated companies have been advised of the possibility of such damages. Some jurisdictions do not allow limitations on liabilities for personal injuries, incidental or consequential damages. If you are in one of these jurisdictions, these limitations might not apply to you.
- Our total compensation for all your damages is limited to the amount you paid for buying our products or services, except where relevant laws apply if our negligence has caused personal injuries or deaths.

## Recommendations

### **Mandatory actions to be taken for cyber security:**

#### **1. Use a strong password**

Refer to the following recommendations for setting up the password:

- The length should not be less than 8 characters
- A strong password is comprised of at least two of these three character types: letters in upper and lower cases, numbers, and special characters.
- Do not contain the user name in its forward or reverse sequence.
- Do not use continuous characters, such as 123 and abc.
- Do not use repeated characters, such as 111 and aaa.

#### **2. Timely update firmware and client software**

- As is standard procedure in the tech-industry, the firmware of devices should be timely updated to the latest version to ensure the system is current with the latest security patches and fixes. With the device connected into Internet, it is recommended to turn on automatic online update detection to timely get firmware updates launched by providers.
- You are recommended to download and use the latest client software.

---

**Recommended measures to enhance cybersecurity:****1. Physical protection**

Physical protection is recommended for devices (especially storage devices), such as placing them in a special room, special cabinet, and well conduct access control and key control to prevent damages to hardware and external devices (U disk, serial ports) by unauthorized persons through physical contact.

**2. Change Passwords Regularly**

Regularly change the passwords to your devices to help ensure that only authorized users are able to access the system.

**3. Timely set up and update password resetting information**

This device supports password reset. To reduce the risk of this function being attacked by hackers, it is recommended to timely set up password reset, including reserved phone number/email, and security questions. If any of such information changes, update the password reset in time. When setting up security questions, set up an answer that is difficult for someone to guess their way into your system.

**4. Enable account lock-down**

Account lock-down is enabled by default. To keep your Account safe, it is recommended to keep this setting. After hackers fail multiple attempts to hack passwords, the corresponding Account and source IPs are locked.

**5. Change HTTP and other default service ports**

These ports can be changed to any set of numbers between 1024-65535. Avoiding the default ports reduces the risk of hackers being able to guess which ports you are using.

**6. Enable HTTPS**

Enable HTTPS to access Web services through safe channels.

**7. Bind MAC Address**

Bind the IP and MAC address of the gateway device to reduce the risk of ARP deception.

**8. Reasonably allocate account and permission**

Add users properly according to business and management needs, and allocate minimum sets of permissions to them.

**9. Turn off Unnecessary Services and Use Safe Modes**

If not needed, SNMP, SMTP and UPnP can be turned off to reduce the risks for the device.

If necessary, it is strongly recommended to use safe modes, including but not limited to:

- SNMP: Select SNMP v3 and set a stronger encryption password and authentication password.
- SMTP: Select TLS to access to the email server.
- FTP: Select SFTP and set a strong password.
- AP hotspot: Select WPA2-PSK encryption mode and set a strong password.

**10. Audio and Video Encrypted Transmission**

If your audio/video data includes important or sensitive contents, use encrypted transmission to make it more difficult for someone to steal your data.

**11. Security Audit**

- Review online users: Do this from time to time to find out illegal login, if any.
- Review device log: This gives you the IP data of a device trying to login and the critical operation information of users already in the login status.

**12. Network Log**

Limited storage capacity of the device cannot store many logs for a long time. If you need to save logs for long, enable online log to ensure key logs are synced to the online log server for easy back tracking.

### **13. Building Safe Network Environment**

To keep the device safer and reduce network risks, we recommend you to:

- Turn off the port mapping of the router to prevent external networks from directly accessing services of router intranet devices.
- Divide network into different partitions as needed: If two subnetworks do not have to establish communications, use VLAN or gatekeeper for network division.
- Build up the 802.1x access authentication to reduce the risk of illegal terminals connecting with your private networks.
- Enable device IP/MAC address filtering to limit the hosts that can access the device.

### **More Information**

Please go to PSIRT on the official Dahua website for security notices and the latest security advisories.



ENABLING A SAFER SOCIETY AND SMARTER LIVING