

# **LM32-U400P Smart Monitor**

## **User's Manual**







# Foreword

## General

This manual introduces the functions, operations, and precautions of the LM32-U400P smart monitor (hereinafter referred to as "the Device"). Read carefully before using the device, and keep the manual safe for future reference.

## Safety Instructions

The following signal words might appear in the manual.

Signal Words	Meaning
 <b>DANGER</b>	Indicates a high potential hazard which, if not avoided, will result in death or serious injury.
 <b>WARNING</b>	Indicates a medium or low potential hazard which, if not avoided, could result in slight or moderate injury.
 <b>CAUTION</b>	Indicates a potential risk which, if not avoided, could result in property damage, data loss, reductions in performance, or unpredictable results.
 <b>TIPS</b>	Provides methods to help you solve a problem or save time.
 <b>NOTE</b>	Provides additional information as a supplement to the text.

## Revision History

Version	Revision Content	Release Time
V1.0.0	First release.	November 2023

## Privacy Protection Notice

As the device user or data controller, you might collect the personal data of others such as their face, fingerprints, and license plate number. You need to be in compliance with your local privacy protection laws and regulations to protect the legitimate rights and interests of other people by implementing measures which include but are not limited: Providing clear and visible identification to inform people of the existence of the surveillance area and provide required contact information.

## Privacy Protection Notice

- The manual is for reference only. Slight differences might be found between the manual and the product.
- We are not liable for losses incurred due to operating the product in ways that are not in compliance with the manual.

- The manual will be updated according to the latest laws and regulations of related jurisdictions. For detailed information, see the paper user's manual, use our CD-ROM, scan the R code or visit our official website. The manual is for reference only. Slight differences might be found between the electronic version and the paper version.
- All designs and software are subject to change without prior written notice. Product updates might result in some differences appearing between the actual product and the manual. Please contact customer service for the latest program and supplementary documentation.
- There might be errors in the print or deviations in the description of the functions, operations and technical data. If there is any doubt or dispute, we reserve the right of final explanation.
- Upgrade the reader software or try other mainstream reader software if the manual (in PDF format) cannot be opened.
- All trademarks, registered trademarks and company names in the manual are properties of their respective owners.
- Please visit our website, contact the supplier or customer service if any problems occur using the device.
- If there is any uncertainty or controversy, we reserve the right of final explanation.

# Important Safeguards and Warnings

This section introduces content covering the proper handling of the device, hazard prevention, and prevention of property damage. Read carefully before using the device, and comply with the guidelines when using it.

## Operation Requirements

### WARNING

- Do not tread on or squeeze the power line, especially the plug or connection point of the power line to the product.
- Please firmly grasp the plug of the connecting line when inserting and removing. Pulling the connecting line might cause damage to it.
- Turn off the power when cleaning the product.
- Do not touch any fixed components inside the product. Failure to do so can result in damage to the product or person.

### CAUTION

- Make sure that the power supply of the device works properly before use.
- Do not pull out the power cable of the device while it is powered on.
- Only use the device within the rated power range.
- Transport, use and store the device under allowed humidity and temperature conditions.
- Prevent liquids from splashing or dripping on the device. Make sure that there are no objects filled with liquid on top of the device to avoid liquids flowing into it.
- Do not disassemble the device.
- Notice and observe all the warnings and illustrations.
- Make sure the power is turned off and the connecting lines are removed when moving the product.
- Do not use uncertified connecting lines, which might cause equipment failure.
- Avoid collisions with the product. This may cause equipment failure.
- Please turn off power for safety if not using the product for a long time.

## Installation Requirements

### WARNING

- Connect the device to the adapter before power on.
- Strictly abide by local electrical safety standards, and make sure that the voltage in the area is steady and conforms to the power requirements of the device.
- Do not connect the device to more than one power supply. Otherwise, the device might become damaged.



- Do not hang or lean on the product. Doing so can cause the product to fall or become damaged. It may also cause injury to people. Pay special attention when children are nearby.
- If the product is installed on the wall, please make sure the wall's load bearing capacity is sufficient. To avoid falling and injuring people, install according to the included instructions with mounting hardware.
- Do not put the product in flammable or corrosive gaseous environment, which may cause fire or damage the product. Placing the product in proximity to flammable gas can easily result in a dangerous explosion.

### CAUTION

- Observe all safety procedures and wear required protective equipment provided for your use while working at heights.
- Do not expose the device to direct sunlight or heat sources.
- Do not install the device in humid, dusty or smoky places.
- Install the device in a well-ventilated place, and do not block the ventilator of the device.
- Use the power adapter or case power supply provided by the device manufacturer.
- The power supply must conform to the requirements of E51 in IEC 62368-1 standard and be no higher than PS2. Note that the power supply requirements are subject to the device label.
- Connect class I electrical appliances to a power socket with protective earthing.
- Do not block the ventilation opening. Install the product according to this handbook.
- Do not place any items on the product. The product may be damaged if foreign objects enter the internal unit.
- Failure to properly secure all screws during installation can result in a fall of the product. Ensure all mounting hardware and other installation accessories are properly secured during installation.
- mounted height <2m
-  Protective earthing terminal. The apparatus should be connected to a mains socket outlet with a protective earthing connection.
- ~ Alternating Current.

## Maintenance Requirements

### WARNING

- Cut off power and the connecting line immediately and contact the after-sales service center if the product or the connecting line is damaged for some reason. Continued use without maintenance might cause smoking or off-odor.
- Please turn off power or unplug the power cable immediately if there is smoking, off-odor, or abnormal noise. Contact the after-sales service center for maintenance after confirming there is no more smoke or odor. Further use could result in fire.

 **CAUTION**

- Do not adjust, maintain or modify if you do not have appropriate qualifications.
- Do not open or remove the rear cover, box or cover board of the product. Please contact the dealer or after-sales service center when in need of adjustment or maintenance.
- Only qualified service people can maintain. If the product gets any kind of damage, such as damage to the plug, foreign matter or liquid into the unit, exposure to rain or humidity, loss of function, or dropped, please contact dealer or after-sales service center.
- Be careful during maintenance of product even if the power is off. Some components are equipped with UPS, and can continue to supply power which is dangerous to people.



The terms HDMI and HDMI High-Definition Multimedia Interface, and the HDMI Logo are trademarks or registered trademarks of HDMI Licensing Administrator, Inc. in the United States and other countries.

# Table of Contents

Foreword -----	I
Important Safeguards and Warnings -----	III
1. Packing List -----	1
2. Monitor Adjustments -----	2
3. Button Description -----	3
4. Cable Connection -----	4
5. Product Specifications -----	5
Appendix 1. Troubleshooting -----	6

# 1. Packing List



The packing list varies depending on the model you purchase. The packing lists in this section are for reference only. The components that come with the Device might be slightly different from those in the figures.

Figure 1-1 Packing list

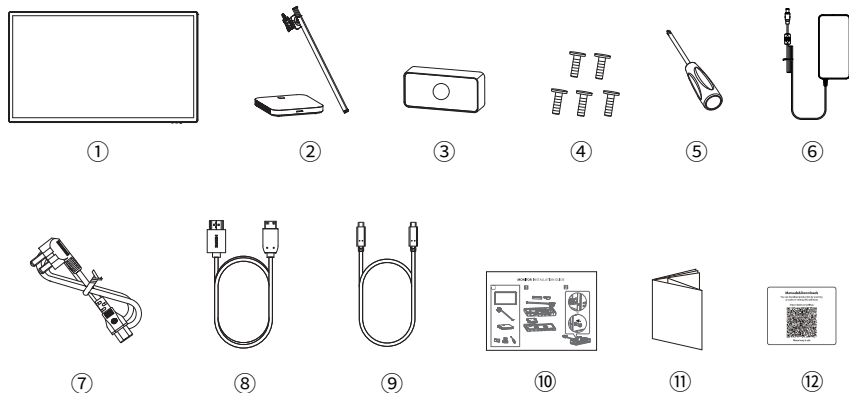

Table 1-1 Packing list description (1)

No.	Name
①	Smart screen (Host)
②	Base/Stand
③	Camera
④	Screws
⑤	Screwdriver
⑥	Power adapter
⑦	Power cable
⑧	HDMI Signal cable
⑨	Type-c Signal cable
⑩	QSG
⑪	Legal and regulatory information
⑫	User's manual QR code stickers

## 2. Monitor Adjustments

The adjustment functions of the display include tilt angle adjustment, screen vertical rotation angle adjustment, left and right rotation angle adjustment, and height adjustment, as shown in the figure below. Different types of displays have different adjustment functions, and the specific adjustment functions are subject to the actual model adjustment functions.

Figure 2-1 Monitor adjustments

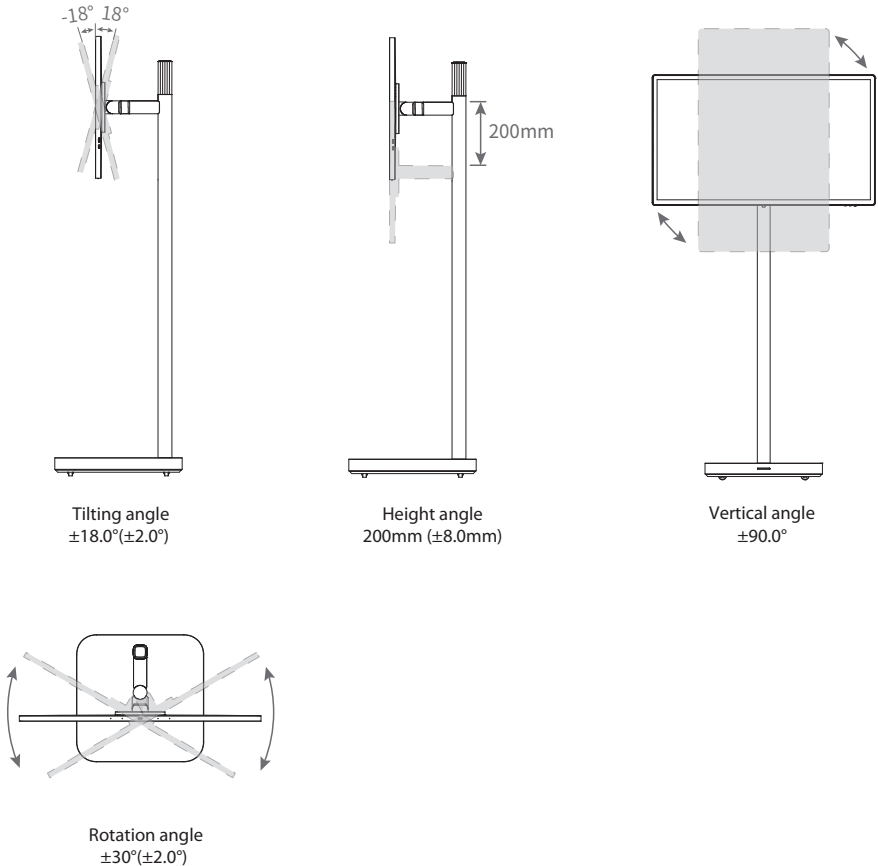

- When adjusting the angle of the monitor, be sure not to touch or press the area of the screen.
- The above figures are for reference only, and everything is subject to the actual adjustment function.

# 3. Button Description

Figure 3-1 Indicator and buttons

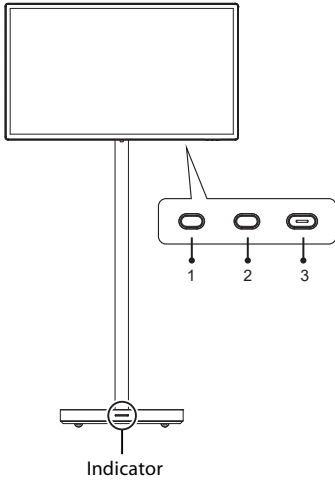

### Buttons description

1	volume down
2	Volume Up
3	Power on/off

### Indicator description

Blue	Power on and work normally
Green	Fully charged (charging state, and power level>98%)
Red	Low power (charging state, and power<10%)
Red and Blue	Low power (power<10%)
No light	Power off

\*In the charging state, when the power reaches 10%~98%, there is no indicator light.



The above content is for reference only, and everything is subject to actual conditions.

## 4. Cable Connection

Figure 4-1 Input and output ports

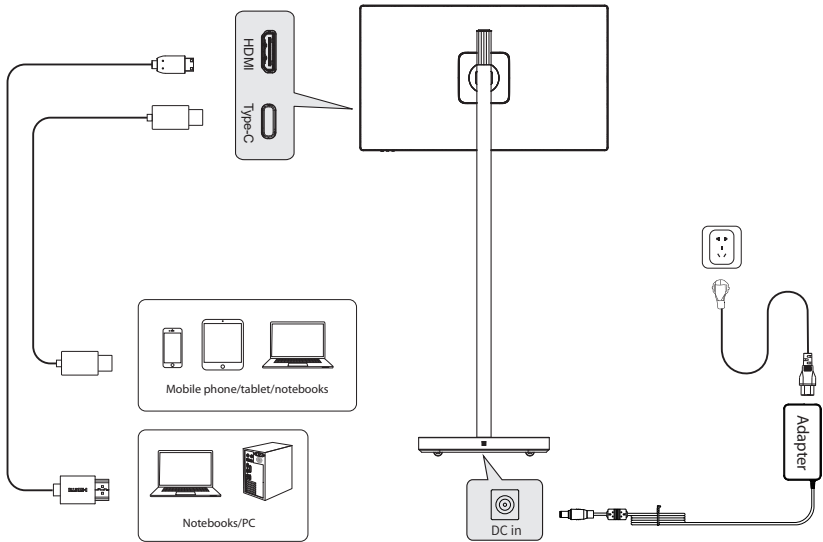

The above ports are for reference only, the actual ports of different types of monitors may be slightly different from the ports in the figure, and everything is subject to the ports and functions of the actual product.

# 5. Product Specifications

Table 5-1 Product specifications

Product model		LM32-U400P
Screen Size		31.5"
Aspect Ratio		16:9
Viewing Angle		178°(H) / 178°(V)
Contrast ratio		3000:1 (TYP)
Colors		16.7M
Resolution		3840x2160
Maximum refresh rate		60Hz
Touch technology		OGM+AF
System		Android 11
CPU		MT8195
DDR+EMMC		8G+128G
Product Dimensions Lifting base	Without base	731.5x428.9x28.3mm
	With base	731.5x1328.9x385mm
Speaker		2*10W
MIC		4 MIC array
Height range		200±8mm
Rotation angle		±30°(±2.0°)
Vertical angle		±90°(±2°)
Tilting angle		Forward tilting : -18° ± 2° Backward tilting: +18° ± 2°
Environmental conditions	Action	Temperature: 0°C~ 40°C (32°F ~ 104°F) Humidity: 10%~90% RH (non-condensing)
	Storage	Temperature: -20°~ 60° (-4°F ~ 140°F) Humidity: 5%~95% RH (non-condensing)

 **NOTE**

The above parameters are for reference only, and the parameters of the actual model shall prevail.



# Appendix 1 Troubleshooting

Appendix Table 1-1 FAQ

Faults occurring	Possible solutions
The power indicator light is not on	<ul style="list-style-type: none"> <li>• Check if the power is on.</li> <li>• Check if the power cord is connected.</li> </ul>
Impossible plug-and-play	<ul style="list-style-type: none"> <li>• Check if the function of plug-and-play of the device is compatible with PC.</li> <li>• Check if the display card is compatible with the plug-and-play function.</li> </ul>
Dimming picture	<ul style="list-style-type: none"> <li>• Adjust brightness and contrast.</li> </ul>
Flickering picture or picture with ripples	<ul style="list-style-type: none"> <li>• There may be electrical appliances or equipment with electronic disturbance.</li> </ul>
The power indicator light is on (flickering),but the monitor has no pictures.	<ul style="list-style-type: none"> <li>• Check if the PC power is on.</li> <li>• Check if the PC display card is inserted properly.</li> <li>• Check if the signal cable of the monitor is correctly connected with the PC.</li> <li>• Check the signal cable plug of the monitor and make sure every pin has no bending.</li> <li>• Observe the indicator light by pressing the Caps Lock key on the PC keyboard and check if the PC is working.</li> </ul>
Color shortage (red, green and blue)	<ul style="list-style-type: none"> <li>• Check the signal cable of the monitor and make sure every pin has no bending.</li> </ul>
The picture is not in the middle, or the size is not right	<ul style="list-style-type: none"> <li>• Hot key(AUTO)</li> </ul>
Picture with color difference (white looks not white)	<ul style="list-style-type: none"> <li>• Adjust RGB color or reselect color temperature.</li> </ul>
Screen font blur under VGA signal	<ul style="list-style-type: none"> <li>• Select the "E" to automatically adjust the image.</li> </ul>
Screen color error under VGA signal	<ul style="list-style-type: none"> <li>• Select "Auto color" in OSD to correct under the white output screen.</li> </ul>

 **NOTE**

The above workarounds are for reference only. If you have any problems, please contact the after-sales service center or find a professional to help.