

# Mobile Digital Video Recorder

## User's Manual

V1.0.0

# Regulatory Information

The regulatory information herein might vary according to the model you purchased. Some information is only applicable for the country or region where the product is sold.

## FCC Information



### CAUTION

Changes or modifications not expressly approved by the party responsible for compliance could void the user's authority to operate the equipment.

#### FCC conditions:

This device complies with part 15 of the FCC Rules. Operation is subject to the following two conditions:

- This device may not cause harmful interference.
- This device must accept any interference received, including interference that may cause undesired operation.

#### FCC compliance:

This equipment has been tested and found to comply with the limits for a digital device, pursuant to part 15 of the FCC Rules. This equipment generate, uses and can radiate radio frequency energy and, if not installed and used in accordance with the guide, may cause harmful interference to radio communication.

- For class A device, these limits are designed to provide reasonable protection against harmful interference in a commercial environment. Operation of this equipment in a residential area is likely to cause harmful interference in which case the user will be required to correct the interference at his own expense.
- For class B device, these limits are designed to provide reasonable protection against harmful interference in a residential installation. However, there is no guarantee that interference will not occur in a particular installation. If this equipment does cause harmful interference to radio or television reception, which can be determined by turning the equipment off and on, the user is encouraged to try to correct the interference by one or more of the following measures:
  - Reorient or relocate the receiving antenna.
  - Increase the separation between the equipment and receiver.
  - Connect the equipment into an outlet on a circuit different from that to which the receiver is connected.
  - Consult the dealer or an experienced radio/TV technician for help.

# Cybersecurity Recommendations

## **Mandatory actions to be taken towards cybersecurity**

### **1. Change Passwords and Use Strong Passwords:**

The number one reason systems get “hacked” is due to having weak or default passwords. It is recommended to change default passwords immediately and choose a strong password whenever possible. A strong password should be made up of at least 8 characters and a combination of special characters, numbers, and upper and lower case letters.

### **2. Update Firmware**

As is standard procedure in the tech-industry, we recommend keeping NVR, DVR, and IP camera firmware up-to-date to ensure the system is current with the latest security patches and fixes.

## **“Nice to have” recommendations to improve your network security**

### **1. Change Passwords Regularly**

Regularly change the credentials to your devices to help ensure that only authorized users are able to access the system.

### **2. Change Default HTTP and TCP Ports:**

- Change default HTTP and TCP ports for systems. These are the two ports used to communicate and to view video feeds remotely.
- These ports can be changed to any set of numbers between 1025-65535. Avoiding the default ports reduces the risk of outsiders being able to guess which ports you are using.

### **3. Enable HTTPS/SSL:**

Set up an SSL Certificate to enable HTTPS. This will encrypt all communication between your devices and recorder.

### **4. Enable IP Filter:**

Enabling your IP filter will prevent everyone, except those with specified IP addresses, from accessing the system.

### **5. Change ONVIF Password:**

On older IP Camera firmware, the ONVIF password does not change when you change the system’s credentials. You will need to either update the camera’s firmware to the latest revision or manually change the ONVIF password.

### **6. Forward Only Ports You Need:**

- Only forward the HTTP and TCP ports that you need to use. Do not forward a huge range of numbers to the device. Do not DMZ the device's IP address.
- You do not need to forward any ports for individual cameras if they are all connected to a recorder on site; just the NVR is needed.

### **7. Disable Auto-Login on SmartPSS:**

Those using SmartPSS to view their system and on a computer that is used by multiple people should disable auto-login. This adds a layer of security to prevent users without the appropriate credentials from accessing the system.

### **8. Use a Different Username and Password for SmartPSS:**

In the event that your social media, bank, email, etc. account is compromised, you would not want someone collecting those passwords and trying them out on your video surveillance system. Using a different username and password for your security system will make it more difficult for someone to guess their way into your system.

#### **9. Limit Features of Guest Accounts:**

If your system is set up for multiple users, ensure that each user only has rights to features and functions they need to use to perform their job.

#### **10. UPnP:**

- UPnP will automatically try to forward ports in your router or modem. Normally this would be a good thing. However, if your system automatically forwards the ports and you leave the credentials defaulted, you may end up with unwanted visitors.
- If you manually forwarded the HTTP and TCP ports in your router/modem, this feature should be turned off regardless. Disabling UPnP is recommended when the function is not used in real applications.

#### **11. SNMP:**

Disable SNMP if you are not using it. If you are using SNMP, you should do so only temporarily, for tracing and testing purposes only.

#### **12. Multicast:**

Multicast is used to share video streams between two recorders. Currently there are no known issues involving Multicast, but if you are not using this feature, deactivation can enhance your network security.

#### **13. Check the Log:**

If you suspect that someone has gained unauthorized access to your system, you can check the system log. The system log will show you which IP addresses were used to login to your system and what was accessed.

#### **14. Physically Lock Down the Device:**

Ideally, you want to prevent any unauthorized physical access to your system. The best way to achieve this is to install the recorder in a lockbox, locking server rack, or in a room that is behind a lock and key.

#### **15. Connect IP Cameras to the PoE Ports on the Back of an NVR:**

Cameras connected to the PoE ports on the back of an NVR are isolated from the outside world and cannot be accessed directly.

#### **16. Isolate NVR and IP Camera Network**





The network your NVR and IP camera resides on should not be the same network as your public computer network. This will prevent any visitors or unwanted guests from getting access to the same network the security system needs in order to function properly.

## Models

MXVR1004 Series

## Safety Instructions

The following categorized signal words with defined meaning might appear in the Guide.

Signal Words	Meaning
 <b>DANGER</b>	Indicates a high potential hazard which, if not avoided, will result in death or serious injury.
 <b>WARNING</b>	Indicates a medium or low potential hazard which, if not avoided, could result in slight or moderate injury.
 <b>CAUTION</b>	Indicates a potential risk which, if not avoided, could result in property damage, data loss, lower performance, or unpredictable result.
 <b>TIPS</b>	Provides methods to help you solve a problem or save you time.
 <b>NOTE</b>	Provides additional information as the emphasis and supplement to the text.

## Terms

To simplify descriptions, frequently cited functions and names in this manual have the following meanings:

- Unless otherwise specified, “Device” in this document refers to “MXVR1004 series products”.
- “Remote devices” in this manual refer to NVR, IPC, speed domes connected with the devices through network.
- “Smart module” in this manual means smart cards installed on devices.
- “IP host” in this manual refers to hosts configured with IP addresses. PC, NVR, IPC, and speed domes are all IP hosts.
- To keep the devices safe, IP addresses, MAC addresses, and serial numbers cited in this manual have all been modified.

## Revision History

No.	Version	Revision Content	Release Date
1	V1.0.0	First release	January 2019

# Important Safeguards and Warnings

The following section describes how to use this product correctly and how to prevent dangers and property loss in using it. Before using this product, read this Manual carefully and comply with it strictly. Keep this Manual properly after reading.

## Requirements

- Do not place or install the device near a heat source or where there is direct sunshine.
- Do not install the device in a humid, dusty, or smoggy place.
- Install the device horizontally or in a stable place. Take measures to prevent it from falling.
- Do not drip or splash liquid onto the device. Make sure that the device does not bear any objects filled with liquid to prevent liquid from flowing into the device.
- Prevent foreign objects from entering the Device, which might result in damage.
- Install the device in a place with good ventilation. Do not clog the air vents of the device.
- Use the device only within the rated input and output range.
- Do not dismantle the device without permission.
- Do not transport the Device with the front panel on the bottom.
- Transport, use and store the Device under the allowed humidity and temperature conditions.
- Do not expose the Device to water or excessive moisture when washing the car. A failure to follow this instruction might result in short circuit, fire, or other malfunctions.
- The dust on the circuit board will cause short circuit, which affect the normal operation of the Device and even damage the Device. To make the Device work stably for a long time, please regularly use the brush to remove the dust from components, including circuit board, connectors, and chassis.
- Keep the Device installed horizontally and make sure the internal anti-vibration components work properly.
- Unlock before plugging or unplugging the SD card; otherwise it might cause damage to the device.
- After all the cables are connected, tie up the cables to avoid the dangers such as short circuit, heat and electric shock resulted from loose cables.
- When a device is connected with a car mount display, mount the camera at least 2m away from the display. If the camera and display are too close, tune down the volume of the car mount display to avoid squeal.

## Power Requirements

- Use the battery exactly as prescribed; otherwise, the battery might catch fire or explode!
- Always replace with the same type of batteries!
- Use the wires (power cords) recommended for the region where the device is used within the specified range of specifications!
- The appliance coupler is a disconnection device. Keep a convenient angle when using it.

- Take care to complete the circuit connection. A failure to follow this instruction might result in Device damage.
- Prevent short circuit from occurring on all external wiring parts.
- After all the lines connections are completed, you can start connecting power cable.
- Ensure the project is well grounded to avoid interference to video and audio signals and avoid electrostatic or induced voltage to damage the Device.
- Unplug the power cable before you remove the audio/video signal cable, RS-232 or RS-485 cable; otherwise these ports might be damaged.

# Table of Contents

<b>Regulatory Information</b> .....	<b>I</b>
<b>Cybersecurity Recommendations</b> .....	<b>II</b>
<b>Foreword</b> .....	<b>IV</b>
<b>Important Safeguards and Warnings</b> .....	<b>V</b>
<b>1 Introduction</b> .....	<b>1</b>
1.1 Product Overview.....	1
1.2 Functions.....	1
<b>2 Dimension and Installation</b> .....	<b>3</b>
2.1 Out-of-box Audit.....	3
2.2 Device Structure.....	3
2.2.1 Front Panel.....	3
2.2.2 Rear Panel.....	4
2.2.3 Interface definitions.....	5
2.2.4 Dimensional Drawing.....	8
2.3 Installation.....	8
2.3.1 Installing SIM Card and SD Card.....	8
2.3.2 Installing Antenna.....	9
2.3.3 Fixing the Device.....	12
2.3.4 Connecting to Power Cables.....	12
2.4 Audio and Video Output Connection.....	14
2.5 Alarm Input and Output Connection.....	15
2.5.1 Alarm Input Type.....	16
2.5.2 Alarm Input Port.....	16
<b>3 Boot up the Device</b> .....	<b>18</b>
<b>4 Local Configurations</b> .....	<b>19</b>
4.1 Initializing Device.....	19
4.2 Logging into the Device.....	21
4.3 Quick Configuration.....	22
4.3.1 Configure IP address.....	22
4.3.2 Configuring General Settings.....	24
4.3.3 Configuring Remote Devices.....	26
4.3.4 Configuring Record Settings.....	30
4.3.5 Set up the storage plan.....	31
4.4 Common Operations.....	34
4.4.1 Live View.....	34
4.4.2 Video Search.....	43
4.5 Alarm Configuration.....	49
4.5.1 Alarm.....	49
4.5.2 Configuring Video Detection Settings.....	65
4.5.3 Configuring Alarm Events Settings.....	66
4.5.4 Abnormality.....	67



4.5.5	Configuring Alarm Output Settings .....	69
4.5.6	Searching Alarm Log .....	70
4.6	System config.....	70
4.6.1	Configuring Camera.....	70
4.6.2	Network Parameters Configuration .....	75
4.6.3	Configuring platform .....	85
4.6.4	Setting Device Storage.....	88
4.6.5	Setting user info.....	92
4.6.6	Set up system services.....	97
4.6.7	Configuring display output.....	99
4.6.8	Configuring RS-232 port function.....	102
4.6.9	Configuring Vehicle Settings.....	103
4.7	System Update.....	106
4.7.1	Viewing system version .....	106
4.7.2	Upgrading System .....	107
4.8	System Maintenance .....	109
4.8.1	Requirement for Maintenance .....	109
4.8.2	Maintaining password.....	109
4.8.3	Querying log .....	112
4.8.4	Review status information .....	113
4.8.5	Auto Maintain .....	115
4.8.6	Backing Up and Restoring.....	117
4.8.7	Restored to the Default Settings .....	119
4.8.8	Network packet capturing.....	120
4.8.9	Shutdown.....	120
<b>5</b>	<b>Web Operations.....</b>	<b>122</b>
5.1	Initializing Device .....	122
5.2	Logging into the Device .....	123
5.3	Quick configuring .....	124
5.3.1	Configure IP address.....	124
5.3.2	Configuring General Settings .....	126
5.3.3	Configuring Remote Devices.....	128
5.3.4	Configuring Record Settings.....	133
5.3.5	Set up the storage plan .....	134
5.4	Common operations.....	137
5.4.1	Live View.....	137
5.4.2	Video playback .....	147
5.4.3	Configuring Alarm Events Settings.....	154
5.5	System Settings .....	155
5.5.1	Configuring lens parameter .....	155
5.5.2	Network Parameters Configuration .....	162
5.5.3	Set alarm information .....	174
5.5.4	Managing storage device .....	182
5.5.5	Configuring system settings .....	183
5.5.6	Safety.....	191
5.5.7	Configuring Vehicle Settings.....	197
5.6	System Update.....	201

5.6.1 View system version .....	201
5.6.2 Upgrading System Firmwares .....	201
5.7 System Maintenance .....	201
5.7.1 Requirement for Maintenance .....	201
5.7.2 System Information.....	202
5.7.3 Auto Maintain .....	203
5.7.4 Backing Up and Restoring.....	205
5.7.5 Network packet capturing .....	207
<b>6 Operating by DSS.....</b>	<b>208</b>
<b>7 FAQ .....</b>	<b>209</b>
<b>Appendix 1 Mouse Operations .....</b>	<b>213</b>
<b>Appendix 2 Storage Capacity Calculation.....</b>	<b>215</b>
<b>Appendix 3 Technical parameters .....</b>	<b>216</b>

## 1.1 Product Overview

Based on the new generation platform, the MXVR1004 series products are onboard video monitoring products that integrate video capturing, locating, and drive recording.

Features:

- Up to 4-channel coaxial video input and 1-channel remote video input; Maximum 400W resolution.
- Compatible with AHD, TVI, and CVBS video signals.
- The use of H.265 encoding ensures high encoding efficiency and saves storage space.
- Netcom wireless network modules (3G, 4G and Wi-Fi modules are optional) are built in after full consideration of network application needs of car mount products.
- The use of professional car-mount design in standard size features low power consumption and novel shape.
- Wide power voltage range adapts to various car mount power supply.

This product can be widely used for car mount monitoring in public transportation, long-range passenger transport, police patrol, urban management patrol, cash carriers, hazardous goods transport, and logistics transport, or video monitoring in harsh environments.

## 1.2 Functions

Function	Description
Storage	Stores the data in the dedicated format which cannot be falsified and ensure the data security.
Compression	Supports multi-channel audio and video signals, and each channel signal supports real-time compression by independent hardware to realize the sync between sound and image.
Backup	<ul style="list-style-type: none"> <li>• Plug in a USB storage device (such as USB flash disk and mobile HDD) to back up</li> <li>• You can back up the data by downloading the files from the SD card through the network.</li> </ul>
Video playback	<ul style="list-style-type: none"> <li>• Every channel supports real-time and independent recording, and you can play backward, monitor on Internet, query and download recordings</li> <li>• Supports several playback modes: Slow playback, fast playback, backward playback, and frame-by-frame playback.</li> <li>• Displays the accurate time when the event occurred during playback.</li> </ul>
Operation through Network	Supports remote operations through network, such as real-time remote monitoring, recorded video search and playback, and PTZ control

Function	Description
Alarm linkage	<ul style="list-style-type: none"> <li>● Provides six routes of electric level alarm inputs that can connect to signals such as car door signal, cornering lamp signal, reversing and braking signal, to give an indication and take a record</li> <li>● Supports one route of electric level alarm output to realize easy alarm linkage</li> <li>● Supports protective circuit for alarm input port and alarm output port, which protect the Device from damage.</li> </ul>
Communication interfaces	<ul style="list-style-type: none"> <li>● Offers RS-485 interfaces to connect with external devices</li> <li>● Offers standard Ethernet ports that support remote network accessing</li> </ul>
Smart operations	<ul style="list-style-type: none"> <li>● Mouse operations</li> <li>● The same settings in the menu can be quickly copied and pasted</li> </ul>
Satellite positioning	Supports positioning function and recording linkage. Recording search can be linked with vehicle moving track
3G/4G, Wi-Fi networks	Adopts the latest wireless communication technology, which has improved the manageability of the Device.
Dual stream	To cope with the low-bandwidth and instability of wireless network, the Device adopts the dual stream technology (respectively encode the real-time video and encode video in network transmission) to optimize the coding of network transmission, which improves the control capability of wireless network transmission
Rollover and collision detection	The integrated G-sensor supports rollover and collision detection and timely releases alarms through the platform

# 2 Dimension and Installation

This introduces how to install the hardware of the Device. Before installing the hardware, you need to know the device information, such as front and rear panels, physical dimensions, and interface definition. After obtaining a sufficient understanding, you can install the SIM card, SD card, antenna, and the device itself as needed.

## 2.1 Out-of-box Audit

When you receive the Device, unpack the box for checks.

Firstly, check if there is any damage on the Device appearance (although the packing materials are specially selected for protecting the Device from most of accidental hit during transportation). Secondly, open the accessory box to check if the accessories are complete against the packing list.

Instructions about front panel, rear panel, and labels:

- The functions of indicator lights and ports are described in the later chapter of the Manual.
- The labels on the Device are very important for our after-sales service. To ensure the after-sales service, **keep the labels well, and do not tear or throw away**. You need to provide the serial number of the product when calling the after-sales service.

## 2.2 Device Structure

### 2.2.1 Front Panel

Describes the functions of the indicators and interfaces of the front panel.

Figure 2-1 Front Panel

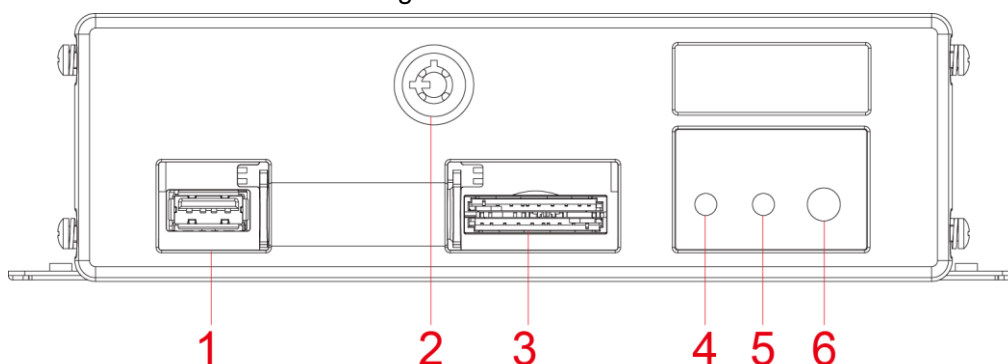

Table 2-1 Descriptions of interfaces and indicators

No.	Name	Descriptions of interfaces and indicators
1	USB interface	For mouse access or USB data backup.
2	Lock switch (Device switch)	<ul style="list-style-type: none"><li>• To plug or unplug the SD card, the Device must be unlocked. In this case, the Device will shut down automatically if powered on.</li><li>• To protect SD card, the Device cannot be powered on if unlocked. Lock the Device before powering on.</li></ul>

No.	Name	Descriptions of interfaces and indicators
3	SD card interface	Hold at most 2 SD cards.
4	PWR	The red light is always on when the Device is powered on, and off when the Device is powered off
5	REC	Recording status indicator. The blue light is always on when recording, and off when not
6	IR	Receives infrared signal from remote control.

## 2.2.2 Rear Panel

Describes the interface functions of the rear panel.

Figure 2-2 shows the rear panel of the Device. Refer to Table 2-2 for interface function description, and “2.2.3 Interface definitions” for interface definitions.

Figure 2-2 Rear panel

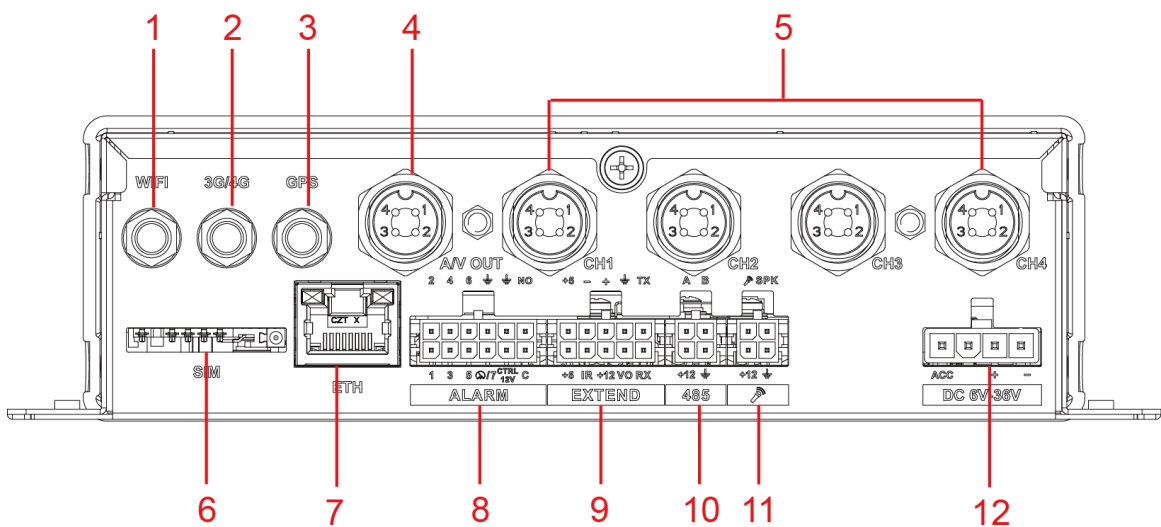



Table 2-2 Descriptions of rear panel interfaces

No.	Name	Function
1	Wi-Fi antenna port	Connects to Wi-Fi antenna and receives Wi-Fi signals. <b>NOTE</b> This function is supported on the Device with Wi-Fi module.
2	3G/4G antenna port	Connects to 3G/4G antenna for receiving 3G/4G signals. <b>NOTE</b> This function is supported on the Device with 3G/4G modules.
3	Positioning antenna port	Connects with positioning antenna for receiving satellite positioning signals <b>NOTE</b> This function is supported on the Device with positioning module
4	AV OUT port	Connects to the display with audio function on the vehicle for simultaneously video and audio data output. For details, see “2.4 Audio and Video Output Connection.”

No.	Name	Function
5	CH1-4	Connects to HDCVI or analog mobile camera, such as CVBS, TVI, and AHD.  <b>NOTE</b> Different devices corresponds to different number of channels
6	SIM card interface	Plug SIM card
7	ETH interface	The aviation port can be converted to an RJ45 interface through a adapter cable. <ul style="list-style-type: none"> <li>• Access to PoE power switch to realize IPC remote access.</li> <li>• Connects to the network to realize the login and Web interface operation of the Device.</li> </ul>
8	ALARM	Alarm input/output port: Includes alarm input/output port, grounding, and 12V output port. For details, see “2.5Alarm Input and Output Connection.”
9	EXTEND port	See “EXTEND Port” introduction.
10	485	Controls the PTZ
11	External pickup port	Connects to external pickup. For details, see “External pickup port” introduction.
12	Power cable	Connects to 6V DC–36V DC power for power supply from vehicle battery. <ul style="list-style-type: none"> <li>• The red end with fuse is the anode of the power supply (always-live wire)</li> <li>• The black wire is the ground wire</li> <li>• The orange one is the ACC signal (key starting wire)</li> </ul>

## 2.2.3 Interface definitions

### NOTE

This Manual only describes functions of all jacks of each interface. You can follow these descriptions to prepare cables or contact our sales staff for purchasing cables.

### 2.2.3.1 CH1-4 Port

Figure 2-3 CH1-4 port

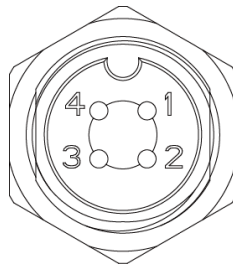



Table 2-3 Port description

No.	Description
1	12V power supply to camera.
2	Grounding port.

No.	Description
3	Grounding port.
4	Video input port to receive video signal from camera.  When your camera is the kind which outputs AHD, TVI or CVBS video signal, the Recorder can only receive the video signal and cannot receive the audio signal; when your camera is the kind which outputs CVI video signal, the Recorder can receive both the video and audio signal.

### 2.2.3.2 Power input

Figure 2-4 Power input interface

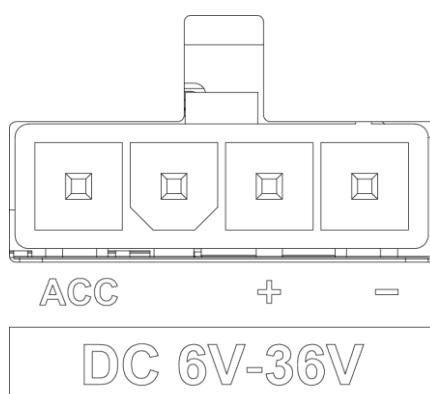
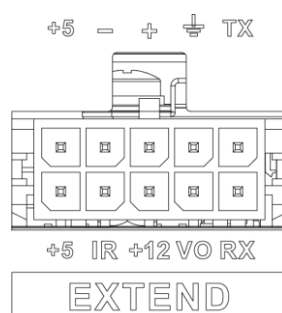

Table 2-4 Power input interfaces (left to right)

Cable color	Pins
Orange	ACC signal input
Red	Anode input
Black	Ground

### 2.2.3.3 EXTEND port

Figure 2-5 EXTEND port



Name	Function
+5	USB +5V (upper line)
+5	USB +5V (upper line)
-	USB data- and USB data+ that connect to USB port.
+	
IR	Remote control signal indicator. Receives signals from remote control.



Name	Function
+12	+12V/1A output.
⏏	Ground
VO	AV video output
RX	RS-232 serial port sender and receiver that connects to RS-232 port
TX	

### 2.2.3.4 External pickup port

Figure 2-6 External pickup port

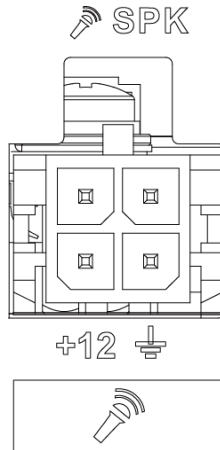

Name	Function
+12	+12V output
⏏	Ground
🎤	Mic In that can connect to pickup.
SPK	For external amplifier.

## 2.2.4 Dimensional Drawing

Figure 2-7 Physical Dimensions (mm)

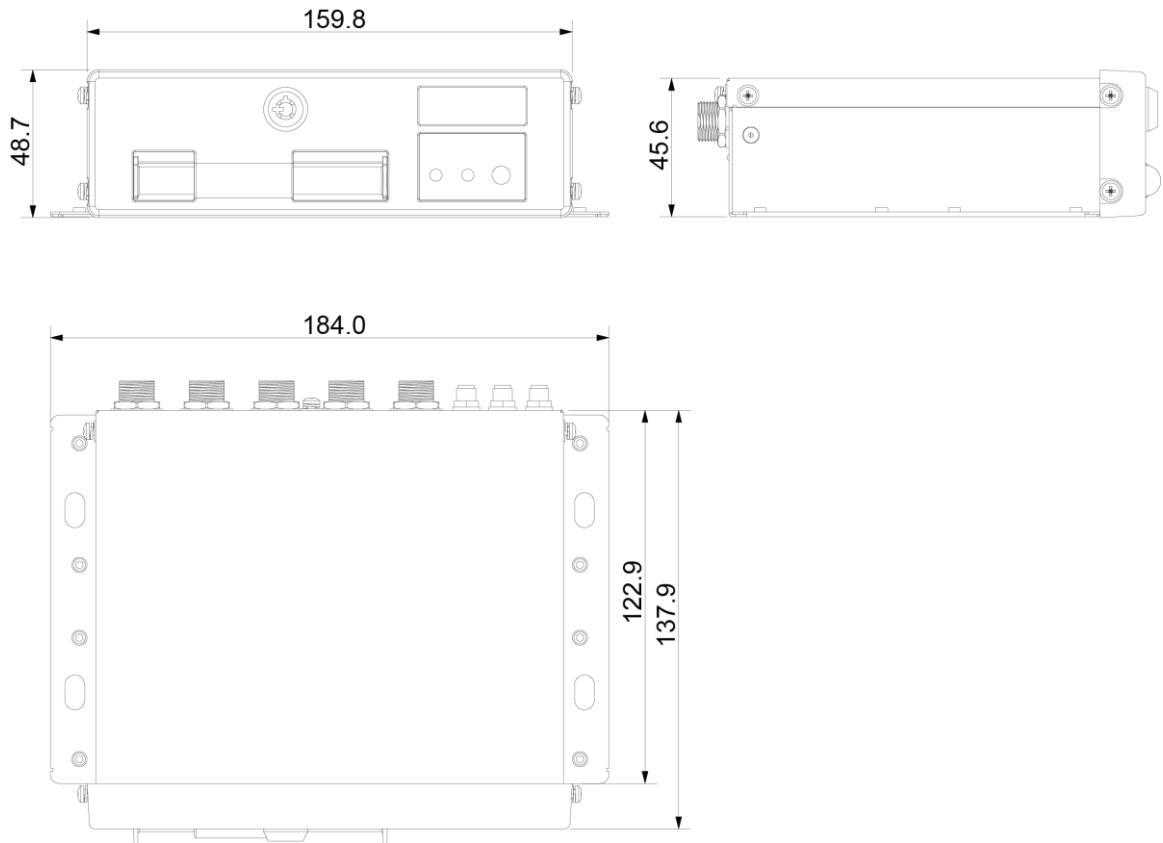

## 2.3 Installation

When you receive the Device, unpack the box to check the Device appearance and structures, and then install SIM card, SD card, and other items according to your network situation and storage requirement.

 **NOTE**

Before the installation is complete, make sure the Device is disconnected from power, and do not plug or unplug components when the power is connected.

### 2.3.1 Installing SIM Card and SD Card

By default, the Device is delivered without the SIM card and SD card. Install them as you need.

- To connect the Device to Internet through dial-up connection, you need to purchase and install a SIM card.

 **NOTE**

Only supports normal SIM card.

- To store recording data, you need to purchase and install an SD card.

### Preconditions

Make sure the power supply is disconnected. If it is not, the Device automatically shuts down when the door lock switch is opened.

## Steps

If the SIM card slot is on the rear panel of the Device, plug the card directly.

If the SD card slot is inside the device, do the following to install the SD card.

Step 1 Use a pass key to open the electronic locker.

Step 2 Remove the SD card stopper.

Step 3 Insert the SD card into the slot with SD marking.

Step 4 Take back the SD stopper, and lock the electronic locker.

## 2.3.2 Installing Antenna

The device antenna is installed to connect the device to the network and to locate the position of the vehicle.

### 2.3.2.1 Installation of Mobile Network Antenna



When installing sticking antenna, make sure there is no metal material below the sticking spot. The large sucker antenna needs to be attached vertically to the metal. In special cases, when the material of the adsorption position is not metal, it can be fixed by double-sided 3M adhesive or gluing.

For installation of mobile network antenna, see 0. Flat antennas and large sucker antennas are recommended to be attached vertically and closely to the vehicle windshield (e.g., on the dashboard, under the windshield) or hidden in the dashboard.

Install the mobile network antenna outside the vehicle. See 0. Large sucker antenna is attached to the roof of the vehicle, the upper of the trunk, or other positions.

Inside installation of Mobile Network Antenna



## Outside installation of Mobile Network Antenna



### 2.3.2.2 Installation of GPS Antenna

Positioning methods include the currently mainstream GPS positioning, Beidou positioning, with corresponding GPS antenna and Beidou antenna.

In this document, GPS antenna is used as an example to illustrate the installation steps of locating antennas. The installation process of other locating antenna is identical.

#### 2.3.2.2.1 Outside Installation

Step 1 Place the GPS antenna on the left front of the roof. See Figure 2-8.

The antenna is magnetically attached to the roof of the vehicle. Glue can be applied to four sides of the antenna to fix more reliably.

#### NOTE

To make the sensitivity and accuracy of positioning free of interference, ensure that there is no high-power electrical or electronic interference source (such as a fan or AC compressor) or obstacles within 1 meter around the GPS antenna.

Step 2 Insert the GPS antenna lead wire into the antenna lead hole on the roof of the vehicle and connect to the GPS antenna port inside the vehicle.

The requirements of the GPS antenna lead hole are as follows.

- The inner radius is at least 10mm.
- It must be waterproof.
- Easy to replace and maintain the antenna.

Figure 2-8 Outside Installation

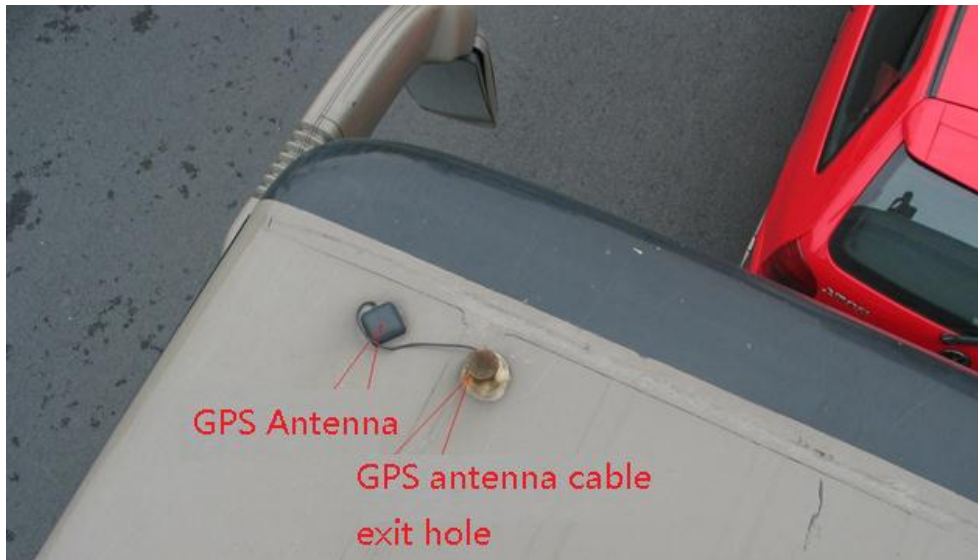

### 2.3.2.2.2 Inside Installation

When limited by waterproof and wiring requirements, the antenna can be installed inside the vehicle.

To select the installation place, it is recommended to place the antenna horizontally on the dashboard close to the windshield, and make the GPS cable facing upward to enhance the signal, as shown in Figure 2-9.

Figure 2-9 Inside Installation





### 2.3.3 Fixing the Device

#### CAUTION

- Install the Device on the vehicle where it cannot be seen from outside. Avoid places with high temperature or near the air conditioning system. High temperature shortens the life of the Device. If going into the Device, the condensing water from the air conditioner can short circuit or burn the Device.
- Power on the Device only after all external devices are connected correctly to the Device.

Step 1 Fix the device onto the vehicle.

- 1) Punch holes on the vehicle according to the installation dimensional drawing.
- 1) Use screws to fix the Device onto the vehicle.

Figure 2-10 Fix the Device onto the vehicle.

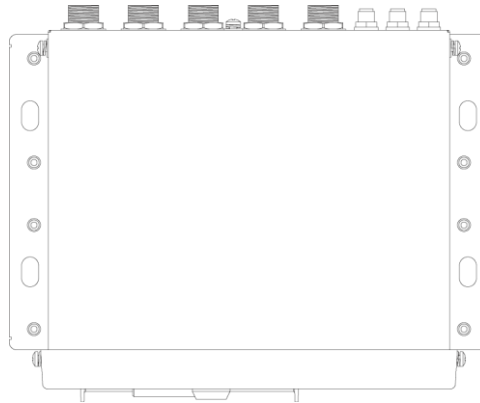

Step 2 Connect cables to the Device.

- Check the voltage of the accumulator. The working voltage of this Device ranges from 6V to 36V. To make sure the Device works stably, directly get power supply from the accumulator.
- When installing the basic wires, do not use excessive force to pull the control wires.

### 2.3.4 Connecting to Power Cables

#### CAUTION

- Before connecting the power cable, confirm whether the input voltage is between 6V DC and 36V DC. If it is out of the range, it will damage the device.
- Please make sure that the positive and negative poles of the power are connected correctly. If not, the device may be damaged.
- The diameter of the power cable should be more than 1.0 mm<sup>2</sup>. Use power cables recommended by our company.
- When connecting the cables to the device, make sure that the main power switch of the vehicle is turned off and the key of the vehicle is placed in the off state.

#### 2.3.4.1 Introduction of Power Cable

For the power cable of the device, see Figure 2-11.

Connect one end of the power cable to the power port of the device (the left port in the figure) or directly use the power cable from the device. Connect the other end to the vehicle battery (the right port in the figure). The red one with fuse is positive pole of the power (normal live). The black one is the grounding cable. The orange one is the ACC signal (Key live).

Figure 2-11 Power cable

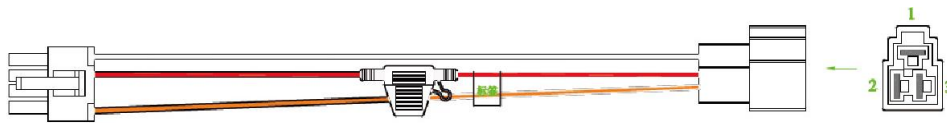

### 2.3.4.2 Obtain Connection Modes of the Main Power Switch

In order to ensure correct cable connection, it is necessary to obtain the connection mode of the main power switch through three methods (is the main power switch connected to the positive or negative pole of the battery?).

- Ask the vehicle manufacture the connection modes of the main power switch of the vehicle.
- Measure with a multimeter: disconnect the main switch, then measure the voltage between the vehicle body and the positive pole of the vehicle battery. If the voltage is 12V or 24V, it means that the main switch disconnects the positive pole. If the voltage is 0V, then the main switch disconnects the negative pole.
- Visual inspection: whether the switch cable near the vehicle battery is connected to the positive pole or the negative pole.

### 2.3.4.3 Connecting Operation

The driving recorder must be connected to the ground wire, ACC signal, and constant electricity.

**Step 1** Enable the main power switch on the vehicle, place the key in the OFF state, and then measure the normal live electricity of the vehicle.

Use a multimeter to measure the voltage on the fuse by switching to the DC voltage range. When the multimeter detects voltage, it measures the normal live electricity on the vehicle. Generally, the voltage is 24V DC for large vehicles and 12V DC for small vehicles. However, this is subject to actual data.

**Step 2** When the vehicle key is placed at the ACC state or the ON state, the ACC signal of the vehicle is measured.

Use a multimeter to measure the voltage on the fuse by switching to the DC voltage range. When the multimeter detects voltage, remove the car key. If the voltage changes to 0V, it means that the measured signal is ACC on the car.

**Step 3** Turn off the main power switch on the vehicle, and place the key in the OFF state.

**Step 4** Connect the power cable according to the main power switch installation mode. See Figure 2-12 and Figure 2-13.



- Before connecting with power cord, select proper fuse. 7.5A fuse is recommended.

- The positive and negative poles of the battery must be equipped with protective devices such as fuses.
- For vehicles where the master power switch is installed at the cathode of the accumulator, isolation installation is needed.

Figure 2-12 Vehicle main power switch installed on the positive pole of the vehicle battery

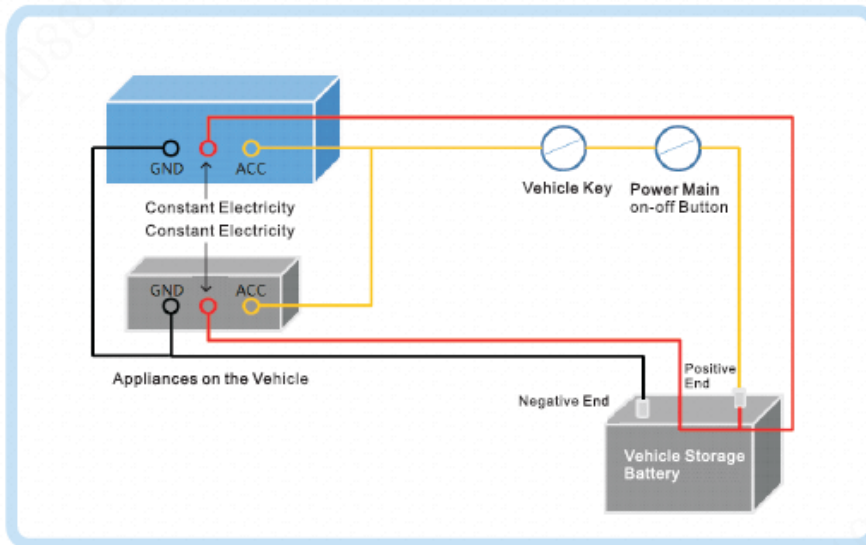
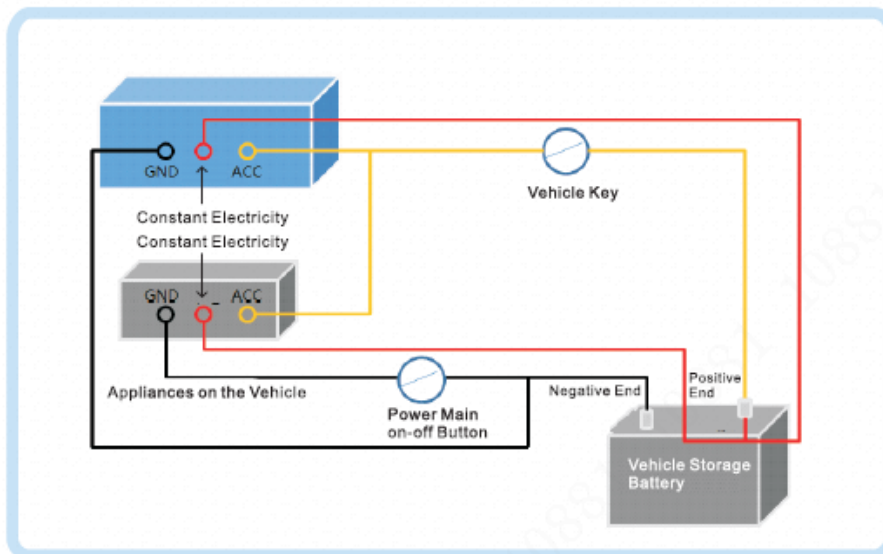

Figure 2-13 Vehicle main switch installed on the negative pole of the vehicle battery



## 2.4 Audio and Video Output Connection

This section helps you understand the connection of audio and video input and output when you need to use this function.

### Introduction of Video and Audio Output Port

The four-cored aviation port (Figure 2-14) can output the video and audio data.



Figure 2-14 Four-cored aviation port

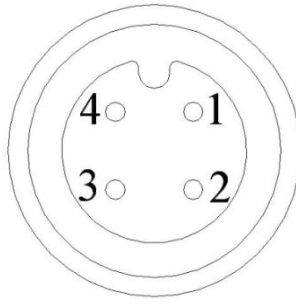

No.	Function
1	12V external power source and no more than 1.5A.
2	Ground line
3	Audio port
4	Video port

## Video Output

The Device is provided with one CVBS (PAL/NTSC 1.0V<sub>P-P</sub>, 75Ω) port, and supports the simultaneous output from these two ports.

Read the following contents carefully before using the computer instead of monitor.

- To extend the Device life, do not keep the Device running for a long time.
- Regular demagnetizing helps keep the monitor working properly.
- Stay away from devices with strong electromagnetic interference.

## Audio output

The audio output signal parameter is larger than 200mv 1KΩ. The audio output port can directly connect to the display with audio function on the vehicle or active speaker, and the port can also drive other sound output devices through amplifier.

## 2.5 Alarm Input and Output Connection

Before using the alarm function, learn about the connections method of alarm input and output port.

### Alarm Input

- The alarm input port supports alarm signal from ground and device of 12V-24V voltage.
- If the alarm device is connected to the Device and other devices, use relay for isolation.

### Alarm Output

The alarm output port cannot be connected to high-power load (less than 1A). When constructing the output circuit, the excessive current should be prevented from causing damage to the relay. Use the contactor for isolation when applying high-power loads.

### PTZ Decoder Connection

- The common-ground must be prepared for PTZ decoder and the Device; otherwise the common-mode voltage might not be able to control the PTZ. It is recommended to use shielded twisted pair, and the shielding layer can be used for common ground.
- Prevent interference from high-voltage power, make reasonable wiring, and take measures for lighting protection.
- Parallel connect 120Ω resistance to reduce reflection and ensure high signal quality.
- The Device RS-458 A line and B line cannot connect to other RS-485 output device in parallel.
- The voltage between the A line and B line must be less than 5V.

## Front-end Device Grounding

The bad grounding might result in chip damage.

## No restriction for types of alarm input

The alarm input can be Always On or Always Closed.

### 2.5.1 Alarm Input Type

Describes alarm input and output ports.

Figure 2-15 Alarm input/output port

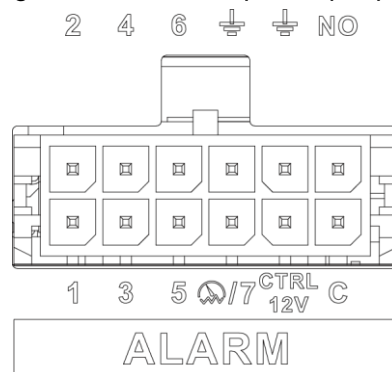

Name	Function
1~7	Alarm input 1~ alarm input 7, in which 1~6 refer to the local alarm input and 7 refers to pulse and alarm combination (it can only be used as pulse or alarm at one time).
C, NO	Outputs alarm signal to alarm device. <ul style="list-style-type: none"> <li>• "NO" represents normally open type.</li> <li>• C: Common alarm output port.</li> </ul>
⏏	Ground line
CTRL 12V	12V/0.75A output with switch control

### 2.5.2 Alarm Input Port

- Both NO and NC are supported.
- The GND of alarm detector is in parallel connection with COM (the power supply of alarm detector should be from external power source). See Figure 2-16.
- The GND of alarm detector is in parallel connection with GND of Device.

- Connect the NC port of alarm detector to the alarm input port (ALARM).
- When supplying power from external power source to the alarm device, the alarm device should be common-grounded with the Device.

Figure 2-16 Always Closed alarm input illustration

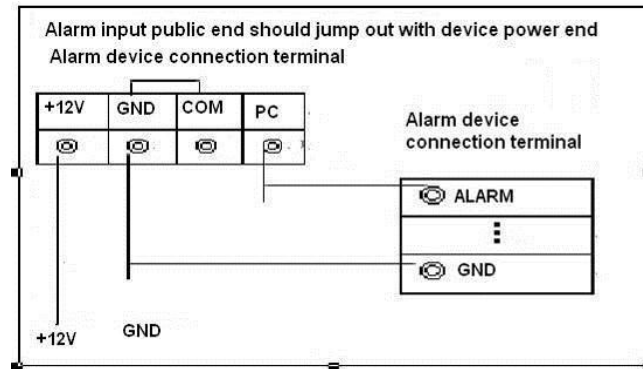

# 3

## Boot up the Device

### CAUTION

- Before booting up the Device, check if input voltage matches rated voltage of the Device.
- Refer to international standard to offer the power input (power input that is with stable power value and less interference ) to ensure the Device works stably and prolong its service life.
- In the first power-on, the Device needs connection to the ACC to work as intended.

Rotate the Device key to  and rotate the vehicle key to ACC position. The power indicator is on, and the Device is ready for work.

### NOTE

For the first boot up or after restoring to the default factory settings, the initialization interface is displayed on the screen. Follow on-screen instructions to initialize your Device prior to use.

# 4 Local Configurations

The Device supports access and operation through the local interface. The local interface supports functions such as real-time preview, recording search, alarm setting, system setting, PTZ control interface, and monitoring window.

## 4.1 Initializing Device

Step 1 Plug the device's power line into a socket.

After the Device is turned on, the initialization interface is displayed. See Figure 4-1.

Figure 4-1 Device Initialization

Device Initialization

1. Enter Pas... → 2. Unlock Pa... → 3. Password ...

User admin

Password  It is 8 to 32-digit containing letter(s), number(s),symbol(s).

Confirm Password  It contains at least two types.

Prompt Question

Next

Step 2 Enter the password, confirm the password and the password hint, and then click **Next**.

The unlock pattern setting interface is displayed. See Figure 4-2.

### NOTE

- To security your account, it is recommended to keep the password properly and change it regularly.
- The password hint can help you recall the password.

Figure 4-2 Unlock Pattern

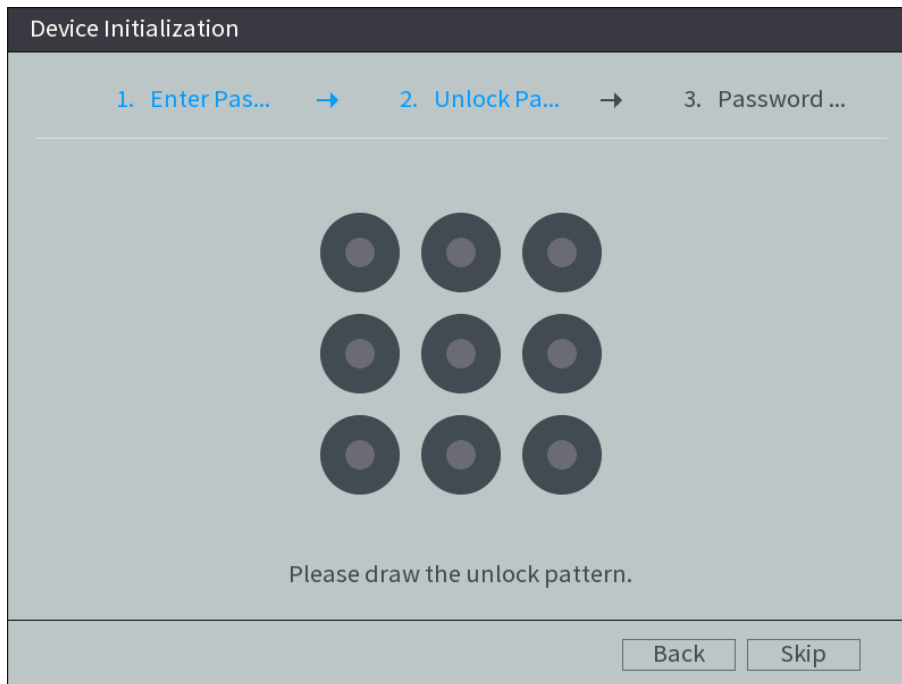

**Step 3** Draw and confirm an unlock pattern. If you do not want to configure the unlock pattern, click Skip.

The password protection interface is displayed. See Figure 4-3.

Figure 4-3 Password protection

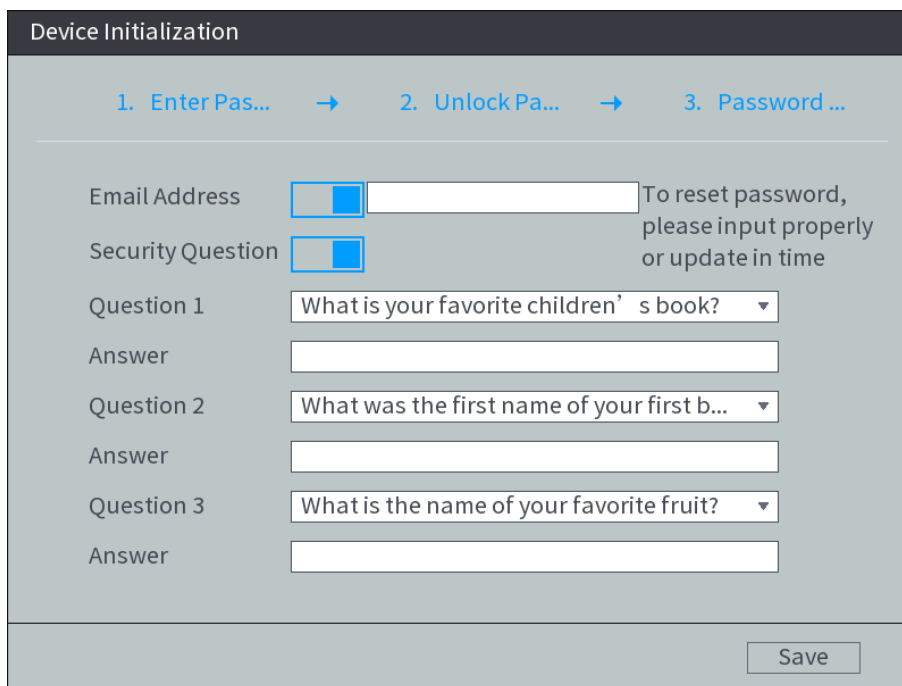

**Step 4** Configure the protection method for password. If you do not want to set the protection, clear both the Reserved Phone Number check box and the Security Question check box.

- Select Reserved Phone Number and enter the phone number. The phone number must be 11-digit number and can be normally communicated.
- Select the Security Question check box, select the question and enter the corresponding answer.

**Step 5** Click **OK**.

## 4.2 Logging into the Device

Step 1 Boot up the Device.

The main interface is displayed. See Figure 4-4.

Figure 4-4 Homepage

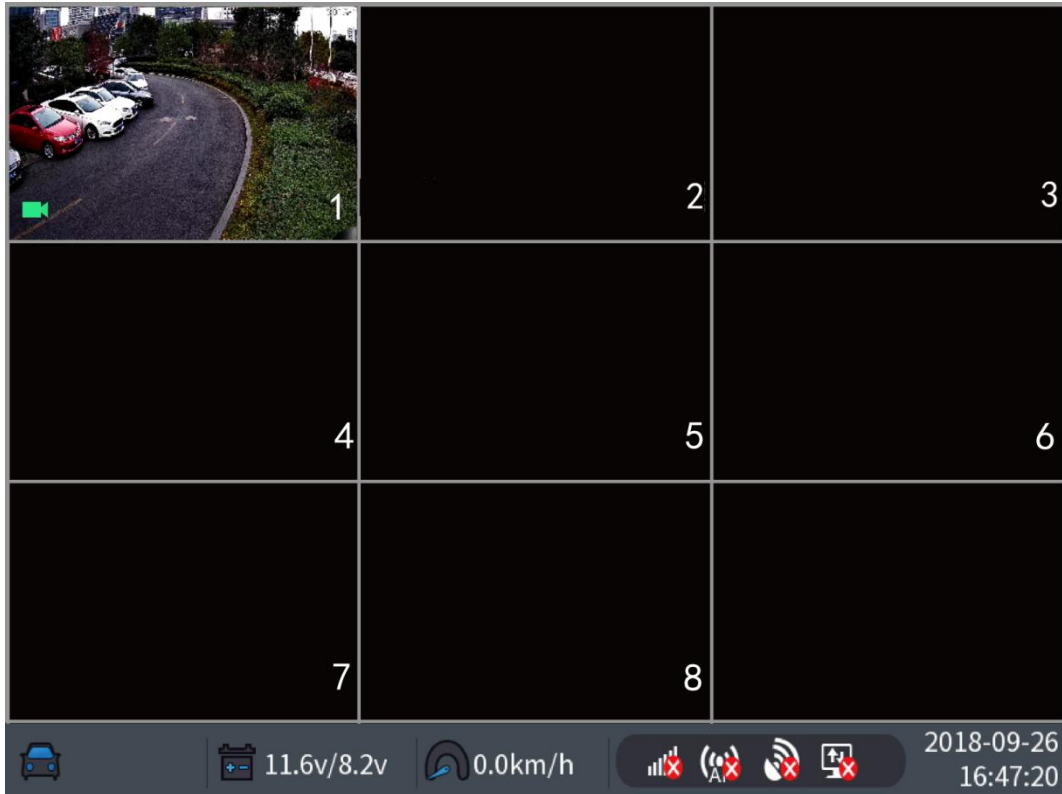

Step 2 Right-click on the live view screen, the shortcut menu is displayed. Then select **Main Menu**.

The SYSTEM LOGIN interface is displayed. See Figure 4-5.

Figure 4-5 Logging in System

SYSTEM LOGIN

Username

Password

**NOTE**

- If the unlock pattern was set during initializing, the unlock pattern login interface is displayed. Then use the unlock pattern to login.
- Click to view the password hint to help you recall the password.
- If the password is lost, click and you can retrieve the password through

security questions or reserved phone number.

**Step 3** Select the **admin** user, and enter the corresponding password that was set during initialization.

**Step 4** Click **OK**.

The **Main Menu** interface is displayed. See Figure 4-6.

Figure 4-6 Main menu

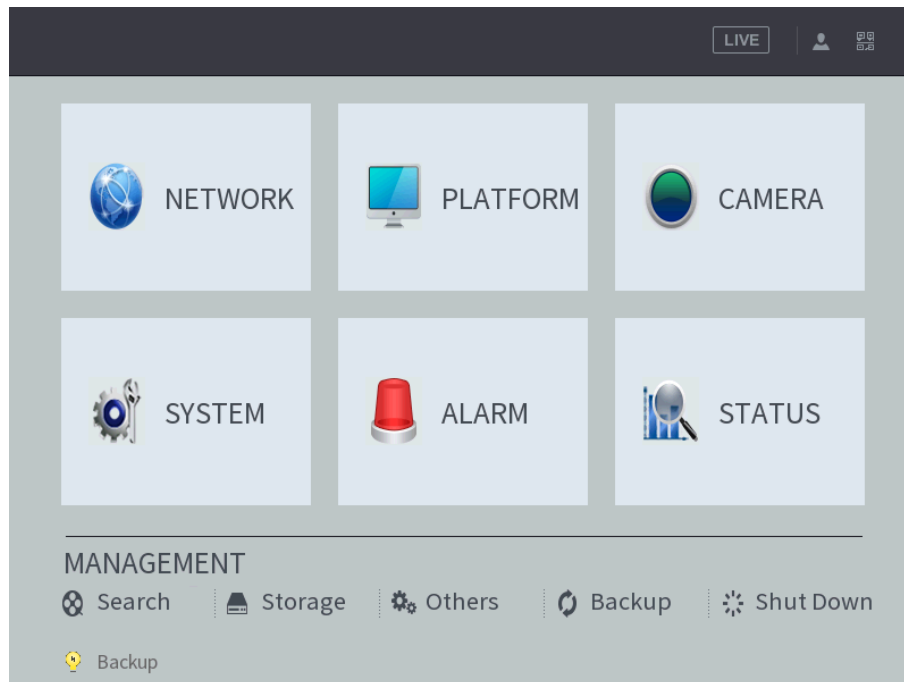

## 4.3 Quick Configuration

After initialization, to ensure normal operation, quickly and conveniently configure basic information, network connection, remote device adding, and recording schedule on the Device.

### 4.3.1 Configure IP address

According to the network planning, configure the IP address of the Device and make sure the Device can connect to other devices in the network.

Connect the Device to the network and make sure the Device can communicate with other devices in the network diagram.

#### Preconditions

Make sure the Device is connected to the network properly.

#### Steps

**Step 1** Select **Network Settings > TCP/IP** under the main menu.

The system displays the **TCP/IP** interface, as shown in Figure 4-7.





Figure 4-7 TCP/IP

IP Version	IPv4
MAC Address	50:65:F3:1D:29:84
DHCP	<input type="checkbox"/>
IP Address	192 . 168 . 20 . 18
Subnet Mask	255 . 255 . 0 . 0
Gateway	192 . 168 . 0 . 1
Preferred DNS	223 . 5 . 5 . 5
Alternate DNS	223 . 6 . 6 . 6

**Step 2** Configure TCP/IP parameters. For details, see Table 4-1.

Table 4-1 TCP/IP parameter description

Name	Description
IP Version	Select <b>IPv4</b> or <b>IPv6</b> . Both versions are supported  <b>NOTE</b> For IPv6 version, in the <b>IP address</b> box, <b>Default Gateway</b> box, <b>Preferred DNS</b> box, and <b>Alternate DNS</b> box, enter 128 bits and cannot be blank
MAC address	Host's MAC address, cannot be modified
DHCP	When the DHCP function is enabled, the system can automatically obtain the IP functions, while <b>IP Address</b> , <b>Subnet Mask</b> and <b>Gateway</b> cannot be configured. You can check the current IP address whether the DHCP takes effect or not
IP address	According to your network plan, enter the modified IP address, gateway and subnet mask  <b>NOTE</b> IP address and gateway must be in the same network segment
Subnet Mask	
Default gateway	
Preferred DNS	IP address of the preferred DNS
Alternate DNS	IP address of the alternate DNS

**Step 3** Click **Apply**.

Click **Test** to test network status of IP address and gateway after IP is configured.

## 4.3.2 Configuring General Settings

To facilitate the application of user, configure basic information of the Device as needed for the first time.

### 4.3.2.1 General

Configure Language, Auto Logout Time, IPC Time Sync, License No. of the vehicle and other information.

**Step 1** Select **System Management > General Setup> Local Settings** under the main menu.

The General interface is displayed, see Figure 4-8.

Figure 4-8 General

**Step 2** Configure TCP/IP parameters. For details, see Table 4-2.

Table 4-2 General settings parameters description

Name	Description
Language	Select a language for the Device system
Video standard	Displays the video encode standard
Auto Logout (minute)	Enter the time period for automatic logout if there are no operations during this period. In this case, you need to login again The value ranges from 0 minutes through 60 minutes. 0 indicates there is not standby time for the Device
IPC Time Sync	The system enables IPC time by default. You can set the interval for IPC sync with the Device based on your needs.
IPC Time Sync Cycle	
License No.	Enter the license plate number of vehicle where the Device is located

**Step 3** Click **Apply**.

### 4.3.2.2 Date and time settings

Inconsistent system time among devices in a same network might cause failure of query, recording playback and other problems.

**Step 1** Select **System Management > General Setup> Date&Time** under the main menu.

The **Date&Time** interface is displayed. See Figure 4-9.

Figure 4-9 Date and time settings

**Step 2** Configure TCP/IP parameters. For details, see Table 4-3.

Table 4-3 Date and time settings parameters description

Name	Description
System Time	Displays the current system date and time
System Time Zone	In the <b>Timing Mode</b> list, if <b>GPS</b> or <b>NTP</b> is selected, configure this parameter Configure the Time zone that the device is at
Date format	Select a date format
Time format	Select a time format
Separator	Separator style used for date.
DST	The DST is applied in some countries or regions. Select the DST check box if it is applied where the Device is located
DST type	
Begin time	
End time	1. Select the <b>DST</b> check box 2. According to the local regulations, configure the type, begin time and end time for the DST
Timing Mode	Select a timing mode, including DSS, GPS, and NTP. The default selection is NTP <ul style="list-style-type: none"> <li>DSS: The system time syncs with DSS platform</li> <li>GPS: The system time syncs with satellite</li> <li>NTP: The system time syncs with NTP server that you configured</li> </ul>

Name	Description
Server	In the <b>Timing Mode</b> list, if <b>NTP</b> is selected, configure this parameter
Synchronize	After configuring NTP server, the Device syncs time with NTP server
Port	3. In the <b>Timing Mode</b> list, select <b>NTP</b> to enable the NTP timing function
Update Period (minute)	4. Configure parameters <ul style="list-style-type: none"> <li>◇ Server: Enter IP address of NTP server</li> <li>◇ Synchronize: Click <b>Synchronize</b> to sync the Device time with NTP server</li> <li>◇ Port: The system supports TCP protocol only and the default setting is 123</li> <li>◇ Interval: Enter the interval that you want the Device to sync time with the NTP server. The maximum value is 65535 minutes</li> </ul>

Step 3 Click **Apply**.

### 4.3.3 Configuring Remote Devices

Remote devices refer to IPC, dome, and other equipment that can be connected to the Device through network. The system supports initialization, remote device adding, etc.

#### 4.3.3.1 Initializing the Remote Device

Initializing the remote device includes configuration of login password and IP address for the remote device. Add and operate a remote device after initialization of the remote device.



- The Device automatically initializes the IPC and the system uses the device password and phone information by default after IPC is connected to the Device through a PoE port.
- The Device initialization might fail after IPC is connected to the Device with an upgraded system version through a PoE port. Initialize the IPC on the **Remote Device** interface.

Step 1 Right-click **Remote Device** on the main interface.

The **Remote** interface is displayed. See Figure 4-10.

Figure 4-10 Remote device

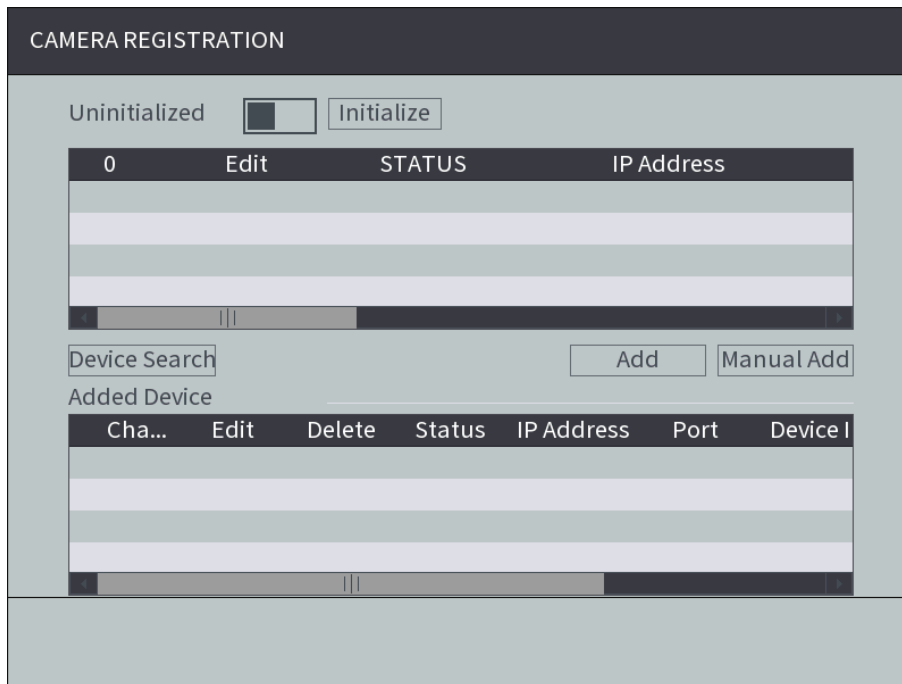

**Step 2** Click **Device Search**.

The searched devices are displayed.

**Step 3** Enable **Uninitialized** function.

The uninitialized devices are displayed.

**Step 4** Select the check box the uninitialized device, and then click **Initialize**.

The **Password Setting** interface is displayed.

**Step 5** Configure the password by either of the following two ways.

- Using current device password and phone info. Select the **Using current device password and phone info** check box, and the remote device uses the password and phone info of the Device.
- Manually configure password for remote devices.
  - 2) Clear the **Using current device password and phone info** check box. The password setting interface is displayed.
  - 3) In the **New Password** box, enter the new password and enter it again in the **Confirm Password** box. Click **Next**. The **Password Protection** interface is displayed.
  - 4) Set up password protection.
    - ◇ Select the **Phone No.** check box, and then enter the phone number. Click **Next**.
    - ◇ Click **Skip** if you do not want to set up password protection. The **Network** interface is displayed.

**Step 6** Configuring network information.

- Set up the network information of the remote device according to your network plan, and click **Next**.
  - ◇ Select **Static**, and manually set up the IP address, subnet mask, and gateway of the remote device. If selecting multiple devices, you can set up the IP address to increase in turn.
  - ◇ When there is a DHCP server in the network, select **DHCP**, and the Device obtains IP addresses from the DHCP server automatically.

- Directly click **Skip** if you do not want to set up the network information or correct network information already exists.

The device initialization begins. After initialization, click **OK**.

### 4.3.3.2 Adding a Remote Device

After a remote device is added, you can view video images transferred by the remote device and modify configuration of the remote device directly on the Device. You can add a remote device manually or by search. Different models of the Device support different number of remote devices to be added. Add remote devices as needed.

Step 1 Right-click **Remote Device** on the main interface.

The **REMOTE** interface is displayed.

Step 2 Adding a remote device.

- Search and Add
  1. Click **Device Search**, the searched devices are displayed.
  2. Double-click on an IP address or select the check box of a device, and then click **Add**.  
The device displays in the added device area.
- Manual Add
  1. Click **Manual Add**.  
The **Manual Add** interface is displayed. See Figure 4-11.

Figure 4-11 Manual Add

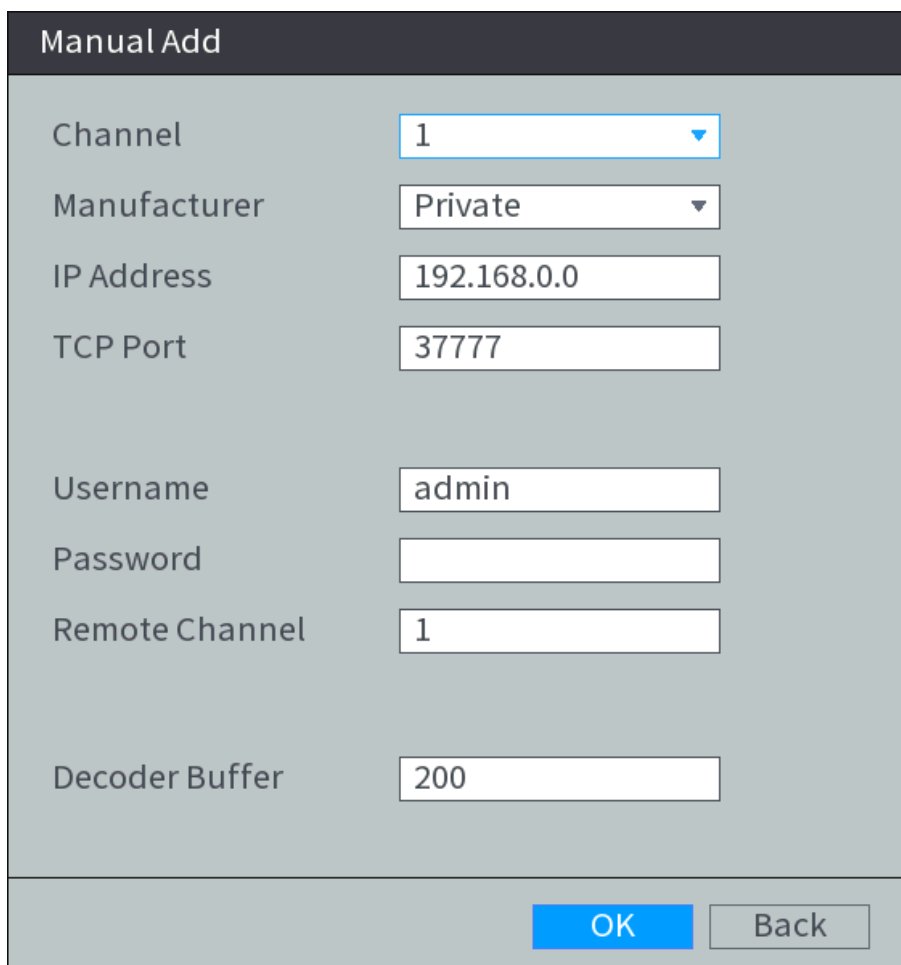

Manual Add	
Channel	1
Manufacturer	Private
IP Address	192.168.0.0
TCP Port	37777
Username	admin
Password	
Remote Channel	1
Decoder Buffer	200

2. Configure TCP/IP parameters. For details, see Table 4-4.

 **NOTE**

The parameters might be different depending on the model you purchased.





Table 4-4 Manual Add Parameter Descriptions

Name	Description
Channel	The channel number of the remotely connected device. You can only select a channel that has not added remote devices
Manufacturers	Select a manufacturer according to the actual situation. Parameters might vary by manufacture. Follow specific parameters on the interface
IP address	Enter the IP address of remote device
TCP Port	TCP service port. The default setting is 37777. You can configure this parameter according to your actual situation
RTSP Port	Enter RTSP Port number of remote device. The default setting is 554
HTTP Port	Configure this parameter when the encryption function is disabled. Enter HTTP Port number of remote device. The default setting is 80
HTTPS port	Configure this parameter when the encryption function is enabled. Enter HTTPs Port number of remote device. The default setting is 430
Username	Enter the user name and password to login to the remote device
Password	
Remote Channel	Select the channel number that you want to connect
Encryption	This parameter must be configured when you select <b>Onvif</b> as the <b>Manufacturer</b> . Enable HTTPs or not. Configure HTTPs Port number when enabled.
Decode buffer	Enter the size of decode buffer. The unit is millisecond and you can select from 80 through 480
Service type	This must be set up when you select <b>Onvif</b> or <b>Custom</b> as the <b>Manufacturer</b> When selecting different manufacturers, the service types are different. Select the service type based on your needs

3. Click **OK**.

The device displays in the added device area.

 **NOTE**

-  indicates connection is successful;  indicates connection failed.
- To delete the remote device, click ; to modify the information of an added device, click  or double-click the added device.

## 4.3.4 Configuring Record Settings

When recording and snapshot functions are enabled, the Device can start recording and snapshot according to the configured recording and snapshot schedule. Recording types include automatic recording and manual recording. You can select recording type according to different stream types.

- Auto: The recording starts automatically according to the record type and recording time as configured in the recording schedule.
- Manual: Keep general recording for 24 hours for the selected channel.



Manual recording operation requires the user have the permission to access **STORAGE** settings.



**Step 1** Right-click **Manual > Record** on the homepage.

The Record interface is displayed, see Figure 4-12.

Figure 4-12 Record

**Step 2** Configure TCP/IP parameters. For details, see Table 4-5.

Table 4-5 Record control parameter description

Name	Description
Channel	The channel that connects to the remote device is displayed. You can select one or several channels or select <b>All</b>
Status	Indicates the recording status of corresponding channels. The choices include Auto, Manual, Enable, and Stop <ul style="list-style-type: none"> <li>• : Selected</li> <li>• : Not selected</li> </ul>



Name	Description
Auto/Manual/Stop	Select the recording mode, including Manual, Auto, and Stop <ul style="list-style-type: none"> <li>Manual: Top priority. When the <b>Manual</b> check box is selected, the system keeps general recording for 24 hours for the corresponding channel</li> <li>Auto: The system starts recording according to the record type (such as general alarm, motion detect, and system alarm) and recording time</li> <li>Stop: Do not record</li> </ul>
Enable/Disable	Enable or disable the scheduled snapshot for the corresponding channels

Step 3 Click **Apply**.

## 4.3.5 Set up the storage plan

Configure recording schedule and snapshot storage according to the actual application scenarios. The Device starts corresponding types of recording and snapshot within a period of configured time.

### 4.3.5.1 Configuring Recording Schedule

The default recording setting is 24 hours general recording for all channels. You can configure conducting various recording types in any recording time.

Step 1 Select **Storage > Schedule > Record** under the main menu.

The **Record** interface is displayed. See Figure 4-13.

Figure 4-13 Record Plan

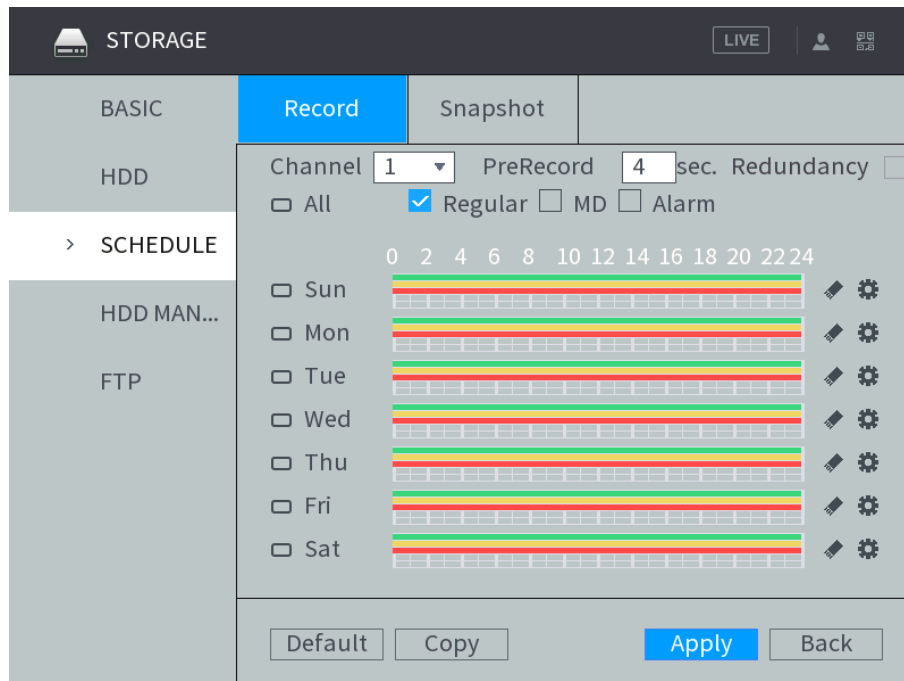

Step 2 Configure TCP/IP parameters. For details, see Table 4-6.

Table 4-6 Record schedule parameters description

Name	Description
------	-------------

Name	Description
Channel	Select a channel to configure the corresponding recording schedule. To configure the same setting for all channels, select <b>All</b>
Pre-record	Start recording for 0 seconds to 30 seconds before the alarm event occurs. If you enter 0 seconds, there will be no pre-recording

**Step 3** Configure the recording time period.

- 1) Click  corresponding to the week.

The **Time Period** interface is displayed. See Figure 4-14.

Figure 4-14 Time Period

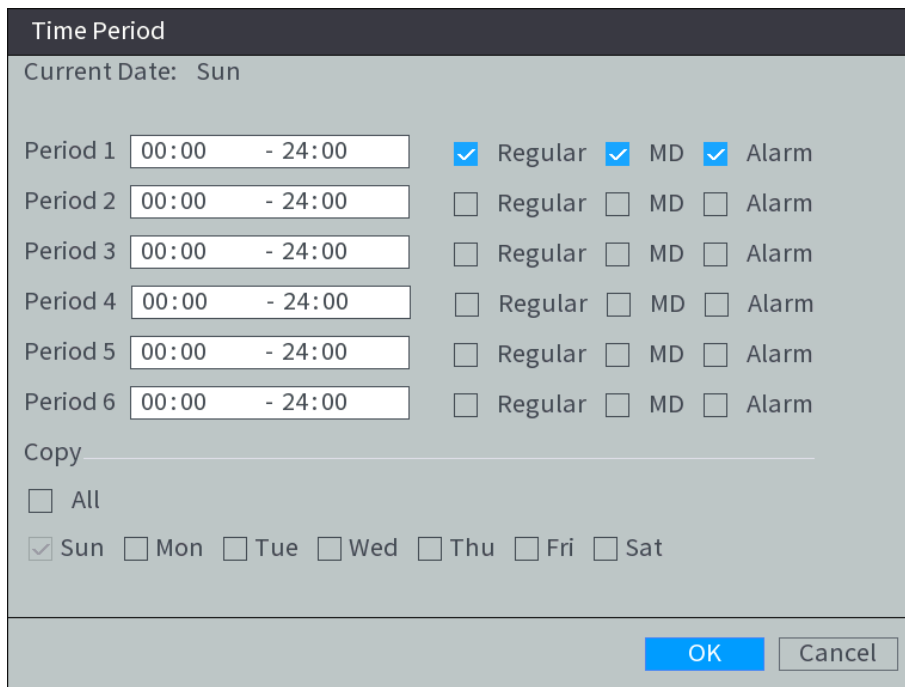

- 2) Select the record type and weekday, and enter the recording period.
- 3) Click **OK**.

The recording schedule appears on the **Record** interface to view the configured recording schedule directly.

**Step 4** Click **Apply**.

 **NOTE**

Click **Copy** to copy the settings to other channels.

### 4.3.5.2 Configure snapshot schedule

After snapshot schedule is configured, the Device starts corresponding types of snapshot according to the configured snapshot schedule.

**Step 1** Select **Storage > Schedule > Snapshot** under the main menu.

The Snapshot interface is displayed. See Figure 4-15.

Figure 4-15 Snapshot

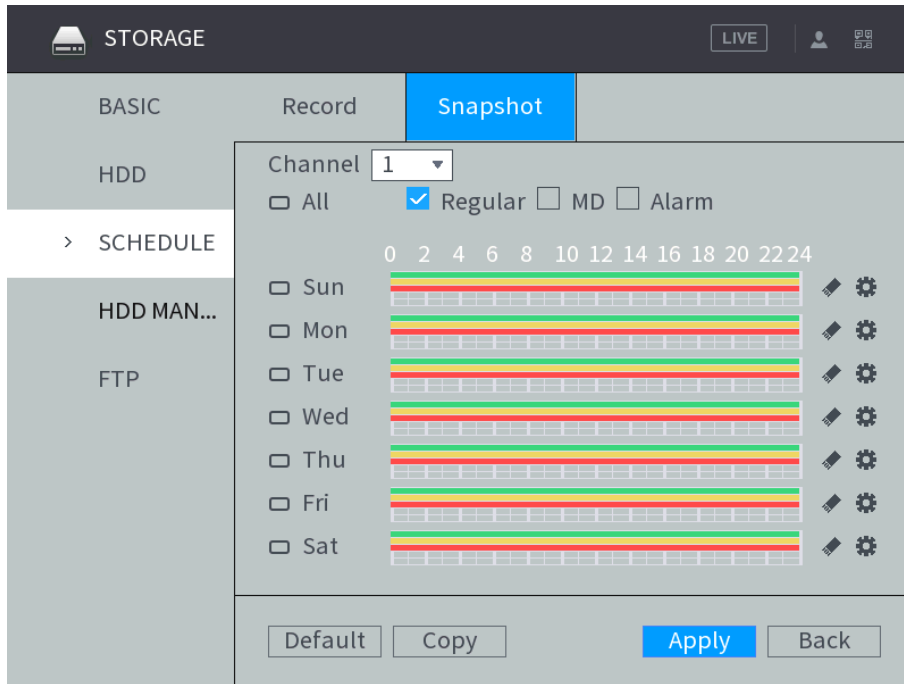

**Step 2** Configuring time period for taking snapshots.

- 1) Click  corresponding to the week.

The **Time Period** interface is displayed. See Figure 4-16.

Figure 4-16 Time Period

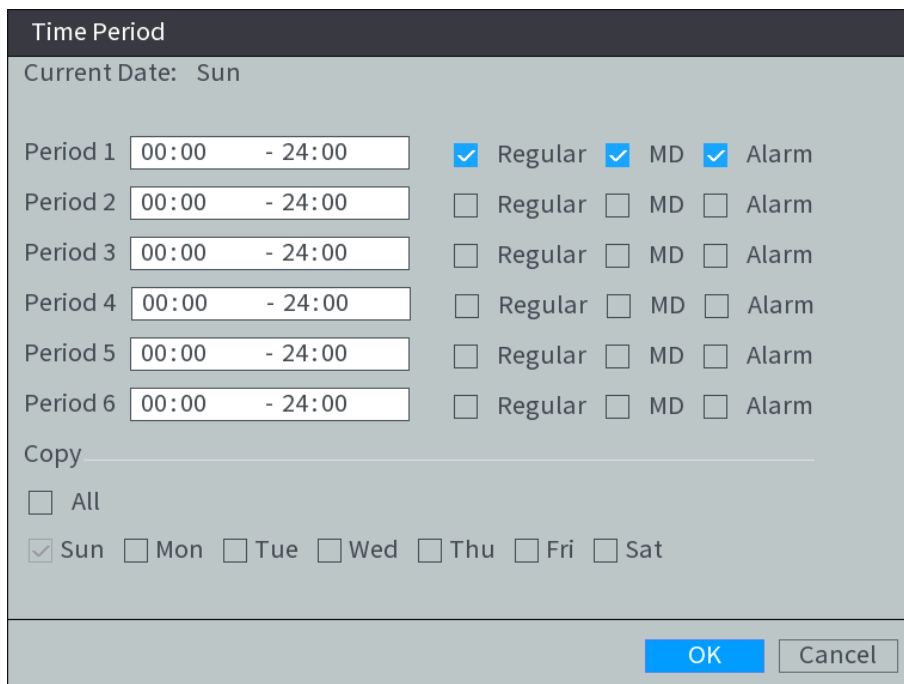

- 2) Select the snapshot type and weekday, and enter the period for taking snapshot.
- 3) Click **OK**.  
Snapshot schedule appears on the **Snapshot** interface to view the configured snapshot schedule directly.

**Step 3** Click **OK**.

## 4.4 Common Operations

### 4.4.1 Live View

#### 4.4.1.1 Previewing real-time pictures

After the Device is turned on, the multi-channel preview interface is displayed. For icon descriptions, see Table 4-7.

##### TIPS



















- See .On the live view interface, the added remote device can be dragged to other channel if needed.
- You can view the information such as time, channel name, GPS, and recording and alarm status in the channel view.
- When you move the pointer to a channel window, the live view control bar is displayed.  
Click  to display the channel window upside down with left and right side reversed.
- The preview mode by default is general. When the face detection is enabled, right-click **Preview Mode > Face** on the preview interface. The face detected is displayed at the bottom of the preview interface.

Table 4-7 Information Bar

Status	Description
Vehicle ACC status	Displays the ACC status of the vehicles  means ACC ON;  means ACC OFF
Voltage status	Displays the accumulator voltage of the vehicle and the voltage of the UPS carried by the Device. The voltage value on the left is the accumulator voltage. The voltage value on the right is the UPS voltage.  means ACC ON;  means ACC OFF
Vehicle speed	Displays the vehicle speed. When the speed increases or decreases, the icon status changes accordingly  means the vehicle is still;  means it has achieved the maximum speed
3G/4G connection status	Displays the 3G/4G connection status of the SIM card and signal strength. The more the bars, the stronger the signals  means no SIM card or no connection with a mobile network.  means the SIM card is installed and reflects signal strength

Status	Description
Wireless network status	<p>Displays the Wi-Fi and hotspot connection status. The more the bars, the stronger the signals</p> <ul style="list-style-type: none"> <li>  means Wi-Fi is available but not connected;  means the Wi-Fi module does not exist;  indicates Wi-Fi is connected and the strength of network signals </li> <li>  means the hotspot is enabled but no terminal connections;  means the hotspot is enabled and there are terminal connections </li> </ul>
Satellite positioning status	<p>Displays the satellite positioning status and signal strength. The more the bars, the stronger the signal</p> <p> means satellite positioning failed;  means successful satellite positioning and signal strength.</p>
Platform registration status	<p>Displays the status of the Device registered to the platform</p> <p> means not registered to the platform;  means registered to the DSS platform;  means successful P2P connection.</p>

#### 4.4.1.2 Shortcut menu

##### Shortcut Menu

Right-click on the live view screen, the shortcut menu is displayed. See Figure 4-17.

##### NOTE

The parameters might be different depending on the model you purchased.

Figure 4-17 Right-click menu

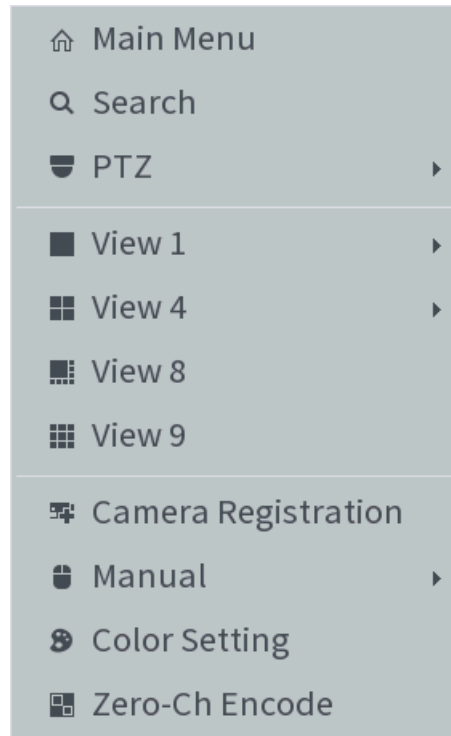

View layout:

- Main Menu: Open Main Menu interface.
- Image splitting: Select View 1, View 4, View 8, and View 9 for image splitting mode. Different model supports different view layout mode.
- Search: Open the playback interface where you can search and play back record files or pictures.
- PTZ: **PTZ Setting** interface is displayed.
- Remote Device: Search and add a remote device.
- Manual: **Record or Alarm Output** interface is displayed.
- Color Setting: **Color Setting** interface is displayed.
- Zero-Ch Encode: **Zero-Ch Encode** interface is displayed.

**NOTE**

After entering the main menu interface, right-clicking on the screen can return to the previous interface.

### 4.4.1.3 PTZ Operations

#### 4.4.1.3.1 Controls the PTZ

Right-click on the live view screen and then select PTZ. The PTZ control panel is displayed. See Figure 4-18.

- PTZ support rotating device toward eight directions, up, down, left, right, left up, right up, left down, right down.
- Speed function controls the movement speed. For example, the rotation with the step length at 8 is faster than the rotation with the step length at 1.
- Click to display or hide the PTZ functions.

Figure 4-18 PTZ Control

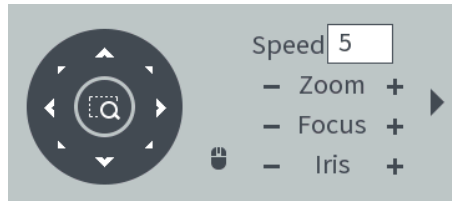

#### 4.4.1.3.2 Configuring PTZ Fn

**Step 1** On the preview interface, right-click **PTZ > PTZ Fn** on the channel of the video image enabled in the single-window screen.

**PTZ Fn** interface is displayed. See Figure 4-19.

Figure 4-19 PTZ Fn

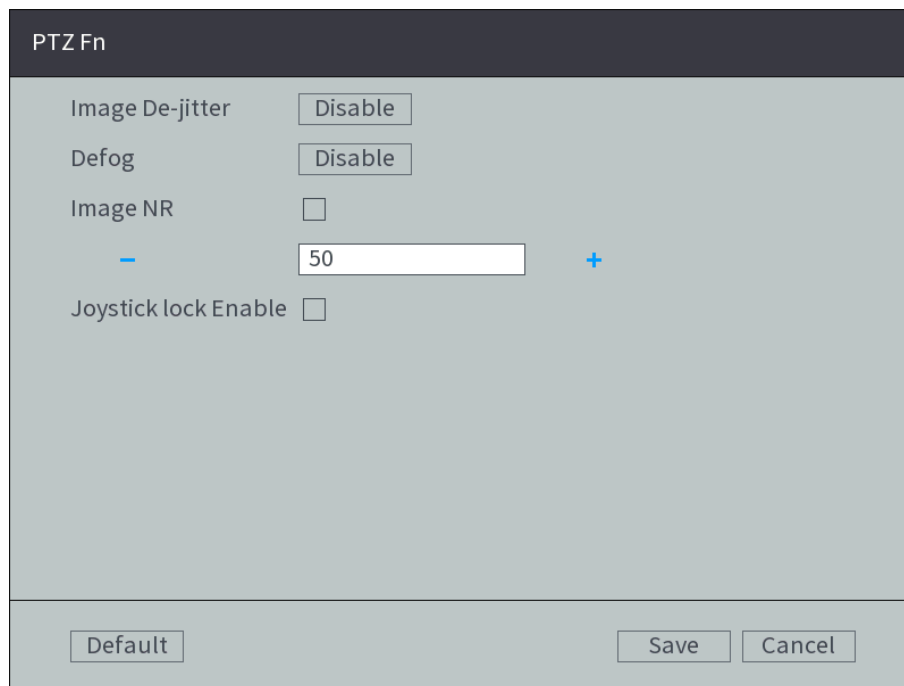

**Step 2** Configure parameters

- Click **Disable** for **Image De-Jitter** to enable the image de-jitter function. When enabled, electronic image stabilization can be realized.
- Click **Disable** for **Defog** to enable the defog function. The system can automatically remove fog in video images to clearly display images in foggy and haze days.
- Check **Image NR** and configure the level of noise removal. The system can reduce the image noise according to the configured level.
- Check **Joystick Lock Enable** to enable the joystick lock function. The joystick of the external keyboard will be locked when enabled. Then the PTZ cannot be operated by using the joystick.

**Step 3** Click **Save**.

#### 4.4.1.3.3 Configuring PTZ Shutter

**Step 1** On the preview interface, right-click **PTZ > PTZ Shutter** on the channel of the video image enabled in the single-window screen.

The **PTZ Shutter** interface is displayed. See Figure 4-20.

Figure 4-20 PTZ Shutter

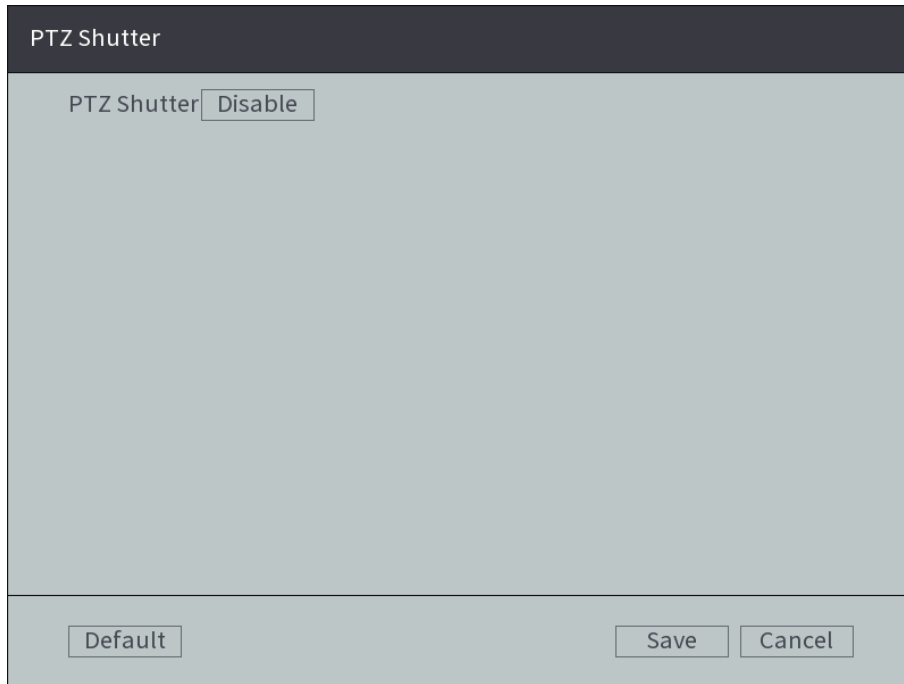

Step 2 Click **Disable** to enable the PTZ shutter.

Step 3 Click **Save**.

#### 4.4.1.3.4 Configuring PTZ Functions

Click . The PTZ function interface is displayed. See Figure 4-21. See Table 4-8 for functions description.

Figure 4-21 PTZ Functions

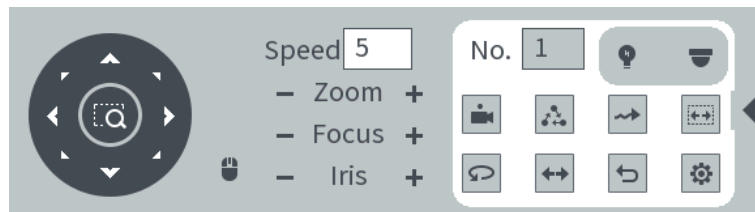















Table 4-8 PTZ Function Description

Function	Description
----------	-------------



Function	Description
Preset point	<p>You can quickly move the PTZ camera to the configured presets after configuration. In the PTZ Setup list, select Preset, and then move the camera to the direction that you want to monitor</p> <ol style="list-style-type: none"> <li>5. Click  to select <b>Preset</b>. The <b>Preset</b> interface is displayed.</li> <li>6. Through the control panel of PTZ, move the camera to the surveillance direction that you need.</li> <li>7. In the Preset box, enter the preset value Value ranges from 1~255 for preset.</li> <li>8. Click <b>Set</b> to complete adding preset.</li> </ol> <p>Return to the PTZ function interface, enter the preset value, and then click , the camera moves to the location of preset.</p>
Calling Tours	<p>The PTZ camera repeats performing tours among the configured presets after configuration</p> <ol style="list-style-type: none"> <li>9. Click  to select <b>Tour</b>. The <b>Tour</b> interface is displayed.</li> <li>10. Set up the value of the tour. The value ranges from 1~255.</li> <li>11. Enter the preset value.</li> <li>12. Click <b>Add Preset</b> or <b>Del Preset</b> to add or delete the presets from the tour.</li> </ol> <p> <b>NOTE</b> You can do this repeatedly to <b>Add Preset</b> or <b>Del Preset</b> from the tour.</p> <p>Return to the PTZ function interface, enter the tour value, and then click . The camera starts rotating according to the configured tour. Click <b>Del</b> to delete the tour.</p>
Touring pattern	<p>The PTZ camera repeats movement according to the configured patterns. The operation records include the information such as the manual operations and focus adjustment</p> <ol style="list-style-type: none"> <li>13. Click  to select <b>Pattern</b>. The <b>Pattern</b> interface is displayed.</li> <li>14. Set the pattern value. The value ranges from 1~255 for pattern.</li> <li>15. Click <b>Start Rec</b>. Then operate the PTZ control panel to adjust the camera with regard to the parameters such as monitoring direction, zoom, and focus</li> <li>16. Click <b>Complete</b> to complete setting.</li> </ol> <p>Return to the PTZ function interface, enter the pattern value, and then click . The camera moves according to the configured patterns.</p>

Function	Description
Scan	<p>After setting up scan, the camera automatically scans the configured left border and right border</p> <p>17. Click  to select <b>Border</b>. The <b>Border</b> interface is displayed.</p> <p>18. Through the PTZ control panel, move the camera to the left border that you want and click Set the left border; move the camera to the right border that you want and click Set the right border. Configuration finished</p> <p>Return to the PTZ function interface. Click  to enable scan.</p>
Pan	<p>Click . The camera PTZ will continuously rotate in a horizontal way by 360 degrees.</p>
AUX	<p>Controls the screen wiper of external device through RS-485 command. To use this function, make sure it is supported on the external device</p> <p>Click  to enable and disable light, wiper or defogging. Use the auxiliary command to enable power-on setting or power-off reset PTZ.</p>
PTZ menu	<p>Click  to enable the PTZ menu. Operate and configure the camera through the PTZ menu.</p>
Flip	<p>Click  to flip display the video image.</p>
Reset	<p>Click  to reset the PTZ.</p>

#### 4.4.1.4 Configuring Image settings

Step 1 Right-click **Image Color** on the digital channel of the enabled video image.  
The **IPC Config** interface is displayed. See Figure 4-22.

Figure 4-22 IPC Config

The screenshot shows the 'IPC Config' window with the following settings:

- Alarm Channel: 1
- Config File: Switch By Period
- Sunrise Time: 00 : 00 : 00
- Sunset Time: 23 : 59 : 59
- Iris: [Slider]
- Mirror: [Slider]
- Flip: [Slider]
- Light: Close
- 3D Denoise: [Slider]
- Scene Mode: Auto
- Red Gain: [Slider] 0
- Blue Gain: [Slider] 0
- Saturation: [Slider] 50
- Brightness: [Slider] 50
- Contrast: [Slider] 50
- sharpness: [Slider] 50
- 3D Denoise: [Slider] 50

Buttons at the bottom: Default, Refresh, Apply, Back.

**Step 2** Configure TCP/IP parameters. For details, see Table 4-9.  
Parameters in gray cannot be configured.

Table 4-9 Color setting parameters description

Name	Description
Time Period	Select the time period to enable the effective time, and then enter the time in the box.
Effective Time	
Brightness	Adjusts the image brightness. The bigger the value is, the brighter the image will become
Contrast	Adjusts the contrast of the images. The bigger the value is, the more obvious the contrast between the light area and dark area will become
Saturation	Adjusts the color darkness. Adjust the saturation according to the actual situation. The bigger the value, the lighter the color will become
Hue	Adjusts the image brightness. Adjust the saturation according to the actual situation. The bigger the value, the brighter the image will become
Sharpness	Adjusts the edge sharpness of images. The bigger the value is, the more obvious the image edge will become
Color mode	Select a color mode for the image that you want to view. Click <b>Custom</b> to customize the color mode.
Image Position	Adjusts the image gains. The bigger the value is, the more obvious the contrast will become and the noises are also greater.

**Step 3** Click **Apply**.

#### 4.4.1.5 Configuring Alarm Output Settings

**Step 1** Right-click **Manual > Alarm Out** on the preview interface.  
The **Alarm Out** interface is displayed. See Figure 4-23.

Figure 4-23 Alarm Output

Alarm Out			
General Alarm			
Alarm Type	All	1	2
Auto	<input type="radio"/>	<input checked="" type="radio"/>	<input checked="" type="radio"/>
Manual	<input type="radio"/>	<input type="radio"/>	<input type="radio"/>
Stop	<input type="radio"/>	<input type="radio"/>	<input type="radio"/>
Status		<input type="checkbox"/>	<input type="checkbox"/>

Apply Back

**Step 2** Select alarm output mode.

- Manual: After the alarm linkage is configured, no matter whether there is an alarm event occurs, the corresponding alarm output port keeps generating alarm.
- Auto: After the alarm linkage is configured, when an alarm event occurs, the corresponding alarm output port generates alarm.
- Stop: After the alarm linkage is configured, no matter whether there is an alarm event occurs, the corresponding alarm output port never generate alarm.

**Step 3** Click **Apply**.

View status of all alarm output ports under **Status**.

#### 4.4.1.6 Multi-channel preview



**Step 1** Right-click **Zero-Ch Encode** on the preview interface.

The **Zero-Ch Encode** interface is displayed. See Figure 4-24.

Figure 4-24 Zero-Ch Encode

**Zero-Ch Encode**

Enable	<input type="checkbox"/>
Compression	<input type="text" value="H.264H"/>
Resolution	<input type="text" value="704x576(D1)"/>
Frame Rate(FPS)	<input type="text" value="25"/>
Bit Rate(Kb/S)	<input type="text" value="1024"/>

Step 2 Click  to enable zero-ch encode.  means enabled.

Step 3 Configure TCP/IP parameters. For details, see Table 4-10.

Table 4-10 Multi-channel encode parameters description

Name	Description
Encode Mode	Encode Mode of video
Resolution	The higher the video resolution, the better the image quality
FPS	Configure the frames per seconds for video. The larger the value is, the smoother and more vivid the image will be.
Bit Stream	Select a value for bit rate of video

Step 4 Click **Apply**.

The zero-ch encode icon is displayed on the **Preview** interface of the WEB screen.

## 4.4.2 Video Search

Right-click **Video Search** on the preview interface. The video playback interface is displayed. See Figure 4-25. See detailed description in Table 4-11.

Figure 4-25 Video playback

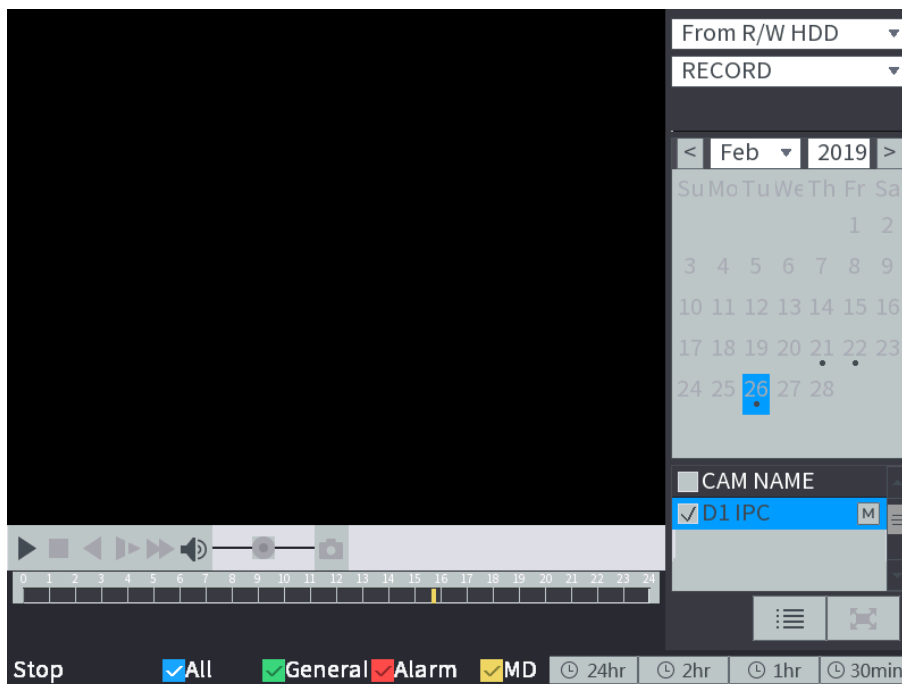







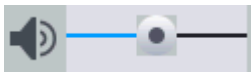



Table 4-11 Play Control Bar

Icon	Function	Description
	Play	When this icon displays, it means the video is paused or not being played, click this icon to play video
	Stop	Click this icon to stop playback
	Play Backward.	Click this icon to rewind.
	Slow Playback.	Click this icon to reduce play speed. Click  to start slow play.
	Speed-up Play	Click this icon to increase play speed. Click  to start fast play.
	Audio	Drag the slider to adjust the volume. Click  to enable mute mode.
	Snapshot	Click this icon to take a snapshot.

#### 4.4.2.2 Playing Back Recorded Video Files

You can play back recorded video by time or file list.

During playing back, you can zoom in an area of image to view the details. To zoom in an area of image, do either of the following:

- Hold down the left mouse button to select the area that you want to enlarge. The area is enlarged after the left mouse button is released. Right-click on the screen to exit zoomed in status.
- Point to the center of the area that you want to enlarge, move the wheel button to zoom

in the area.

After entering the zoomed in status, you can drag the enlarged area to move to any directions to view details of other parts of image. Right-click on the enlarged image to return to the original status.

#### 4.4.2.2.1 Playing Back by Date

Step 1 The search sources include From R/W HDD and redundancy HDD.

The search sources include From R/W HDD and redundancy HDD. The redundancy HDD is supported only when there is a redundancy HDD on the Device. For details about redundancy HDD operations, see “4.6.4.2Managing Storage Device.”

- From R/W HDD: Play back recorded videos from local HDD of the Device.
- From redundancy HDD: Play back recorded videos from redundancy HDD of the Device if it is supported.

Step 2 Select the month, year, and channel number that you want to search.

Step 3 Select date and record type.

Figure 4-26 Record Type

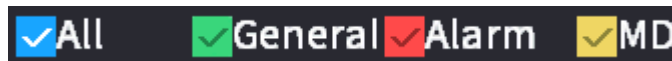

Step 4 Click  to start playing back recorded video.

#### 4.4.2.2.2 Playing Back by File List

Step 1 The search sources include From R/W HDD and redundancy HDD.

The search sources include From R/W HDD and redundancy HDD. The redundancy HDD is supported only when there is a redundancy HDD on the Device. For details about redundancy HDD operations, see “4.6.4.2Managing Storage Device.”

- From R/W HDD: Play back recorded videos from local HDD of the Device.
- From redundancy HDD: Play back recorded videos from redundancy HDD of the Device if it is supported.

Step 2 Select the month, year, and channel number that you want to search.

Step 3 Select a date.

Step 4 Click .

The recorded videos are displayed in list. See Figure 4-27.

Figure 4-27 File list

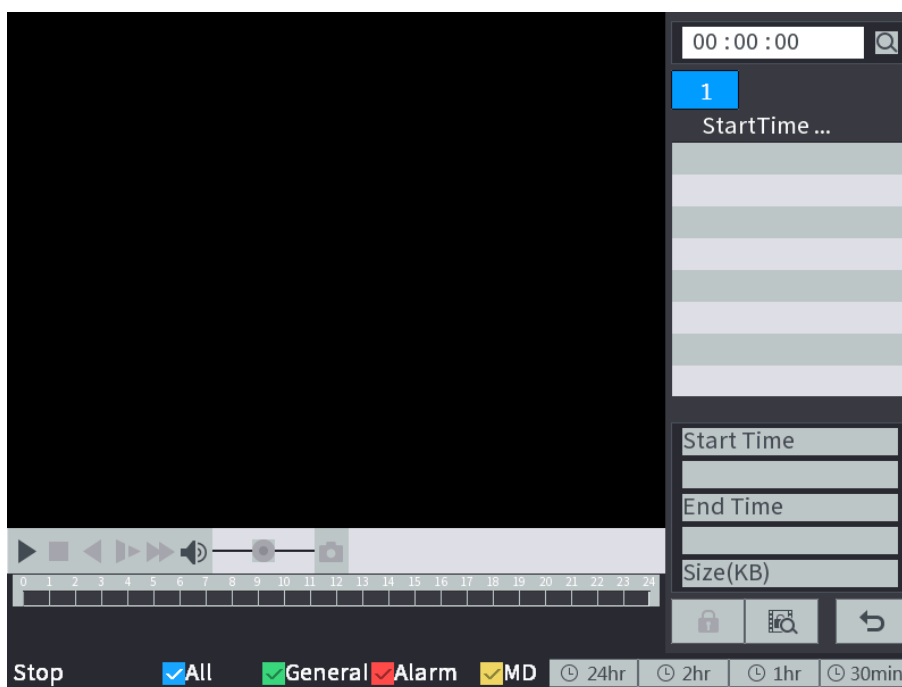

**Step 5** Set up the start time of the queried file list, and then click . The queried recording files are displayed.

Record type: R indicates regular record; A indicates alarm; M indicates motion detection.

**Step 6** Double-click the recorded video file to start playing back recorded video.

Select a recorded video, and then click  to lock the video file. The locked

video file will not be covered. Click  to view the locked video file and unlock it.

### 4.4.2.3 Playing Back Snapshots

You can play back snapshots by time or file list.

#### 4.4.2.3.1 Playing Back Snapshots by Time

**Step 1** In the search type list, select PIC. Select where you want to search the snapshots, and enter the interval time.

The search sources include From R/W HDD and redundancy HDD. The redundancy HDD is supported only when there is a redundancy HDD on the Device. For details about redundancy HDD operations, see “4.6.4.2Managing Storage Device.”

- From R/W HDD: Play back snapshots from local HDD of the Device.
- From redundancy HDD: Play back snapshots from redundancy HDD of the Device if it is supported.

**Step 2** Select the month, year, and channel number that you want to search.

**Step 3** Select a date.



**Step 4** Click .

The system is playing back snapshots according to the configured interval.

#### 4.4.2.3.2 In the search type list, select PIC.

**Step 1** Select where you want to search the snapshots, and enter the interval time.

The search sources include From R/W HDD and redundancy HDD. The redundancy HDD is supported only when there is a redundancy HDD on the Device. For details about redundancy HDD operations, see “4.6.4.2Managing Storage Device.”

- From R/W HDD: Play back snapshots from local HDD of the Device.
- From redundancy HDD: Play back snapshots from redundancy HDD of the Device if it is supported.

**Step 2** Select the month, year, and channel number that you want to search.

**Step 3** Select a date.

**Step 4** Click .

The snapshots are displayed in list. See Figure 4-28.

Figure 4-28 File list

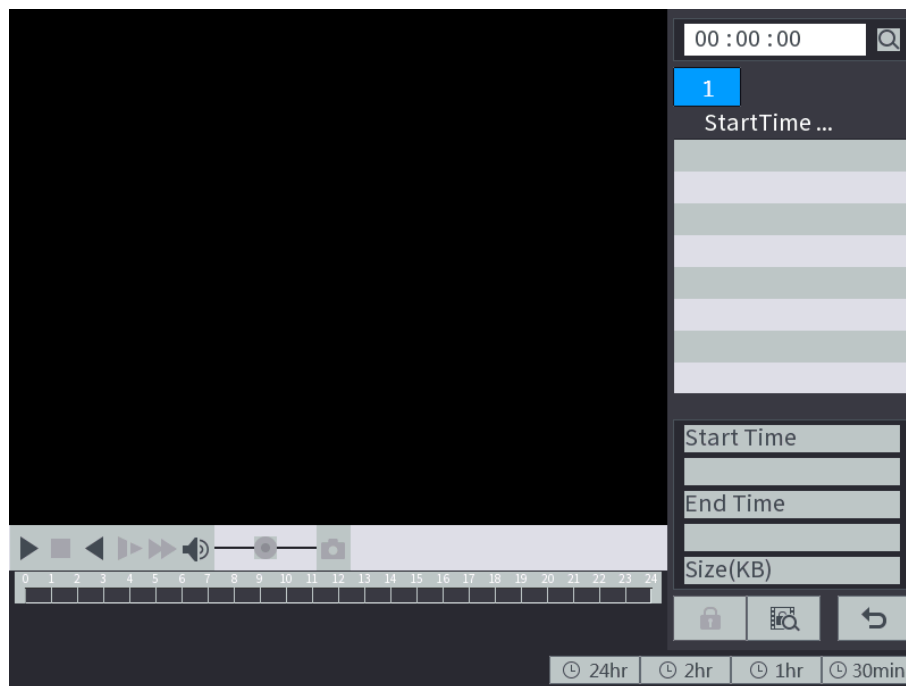

**Step 5** Set the start time, and then click , the searched snapshots are displayed.

**Step 6** Double-click the snapshots folder or click .

The system is playing back snapshots according to the configured interval.

#### 4.4.2.4 Recorded files backup

You can back up the recorded video file into the external storage device.

## Preconditions

Make sure the external storage device such as USB flash disk is connected to the Device.

## Steps

**Step 1** Select Main Menu > **BACKUP**.

The **BACKUP** interface is displayed. See Figure 4-29. The detected external storage devices are displayed with the corresponding space information and status.

### NOTE

- Select the external storage device, and then click **Format** to clear the data in the external storage device.
- Select the external storage device, and then click **Switch To R/W** to transfer the external storage device to the record storage HDD. The system automatically saves the recorded videos to the external storage device.
- During backup, click **Stop** to stop backing up.

Figure 4-29 Files backup

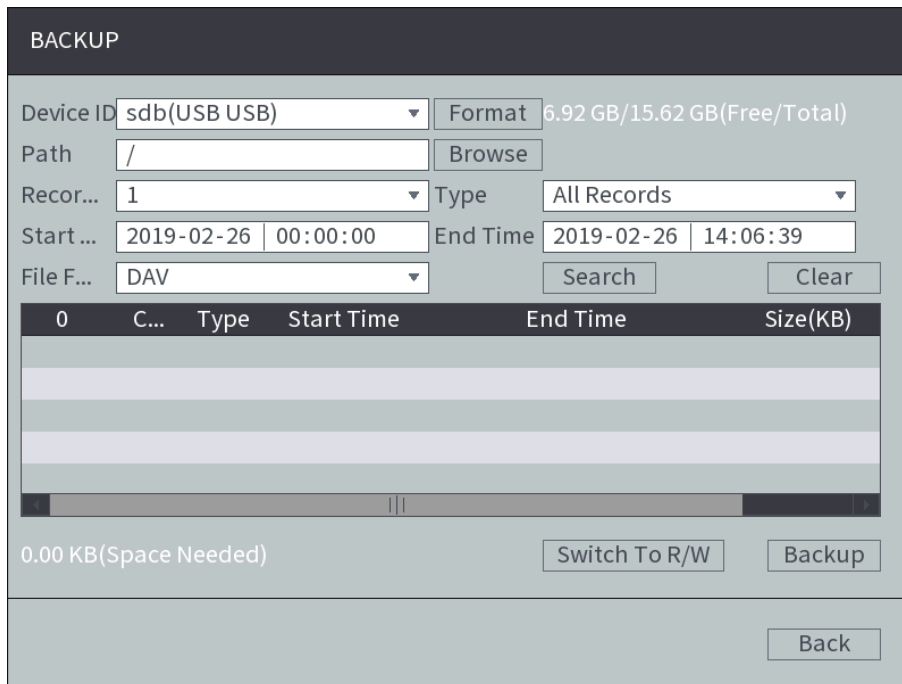

The screenshot shows the 'BACKUP' interface with the following fields and controls:

- Device ID: sdb(USB USB) (dropdown), Format: 6.92 GB/15.62 GB(Free/Total)
- Path: / (input field), Browse (button)
- Reco...: 1 (dropdown), Type: All Records (dropdown)
- Start ...: 2019-02-26 00:00:00 (input), End Time: 2019-02-26 14:06:39 (input)
- File F...: DAV (dropdown), Search (button), Clear (button)

0	C...	Type	Start Time	End Time	Size(KB)

0.00 KB(Space Needed)      Switch To R/W      Backup

Back

**Step 2** Click **Browse** to select the storage path of recorded videos in an external storage device.

**Step 3** Search recorded video.

- 4) Select path, record channel, type, start time, end time and file format.
- 5) Click **Search**.

The list of satisfied recorded video files is displayed. See Figure 4-30.

### NOTE

Click **Clear** to delete the searched recorded files.

Figure 4-30 List of recorded video files

**BACKUP**

Device ID:  Format: 6.92 GB/15.62 GB(Free/Total)

Path:

Recor...:  Type:

Start ...:   End Time:

File F...:

657	<input checked="" type="checkbox"/> C...	Type	Start Time	End Time	Size(KB)
1	<input checked="" type="checkbox"/> 1	R	17-12-12 19:52:58	17-12-12 19:57:25	122171
2	<input checked="" type="checkbox"/> 1	R	17-12-12 20:09:41	17-12-12 21:00:00	1547402
3	<input checked="" type="checkbox"/> 1	R	17-12-12 21:00:00	17-12-12 22:00:00	1847387
4	<input checked="" type="checkbox"/> 1	R	17-12-12 22:00:00	17-12-12 23:00:00	1847439
5	<input checked="" type="checkbox"/> 1	R	17-12-12 23:00:00	17-12-13 00:00:00	1847546

129.58 GB(Space Needed)

**Step 4** Select the file that you want to download, and then click Backup. The progress and remaining time are displayed by a progress bar during backup. Click OK to complete backup. You can view the backup files on PC.

 **NOTE**

You can view the backup files on PC. The file format is “Channel number\_Record Type\_Time.dav.” The format for time is “year/month/date/hour/minute/second.”

## 4.5 Alarm Configuration

### 4.5.1 Alarm

After the arming and disarming period and the alarm linkage action are configured, the system will start the corresponding linkage in the arming and disarming period.



Take the configuration of dynamic alarm linkage detection as an example. The alarm linkage might be different depending on the alarm. The actual interface shall prevail.

**Step 1** In the main menu, select **Alarm > Video Detection > Motion Detect**.

The Motion detection interface is displayed, see Figure 4-31.

Figure 4-31 Motion detection

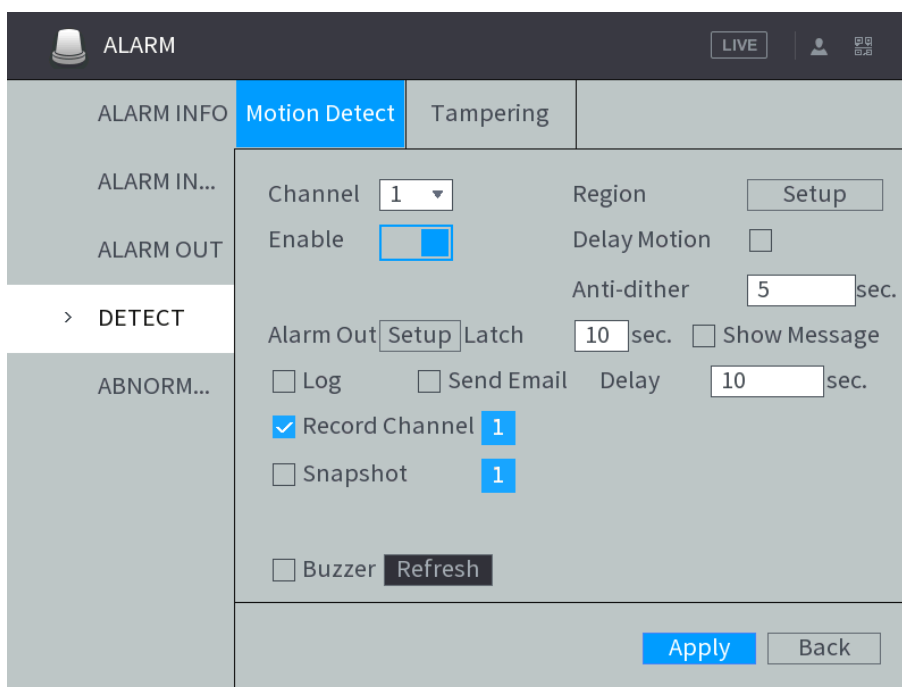

**Step 2** Select the channel number, and click  to enable the motion detection for the channel.

**Step 3** Configure jitter removal time and enable delay motion detection.

- If there are multiple alarms during this period, the system records only one alarm event.
- After the delay motion detection is enabled, motion detection begins after a period of time.

**Step 4** Set detecting area

1) Next to **Region**, click **Setup**.

The Area interface is displayed, see Figure 4-32.



The monitoring image is divided to 22×18(PAL) or 22×15(NTSC) blocks.

- PAL (Phase Alteration Line) applies to the countries and regions including China and Europe.
- NTSC (Nation Television Standards Committee) applies to the countries and regions including America and Japan.

Figure 4-32 Area interface

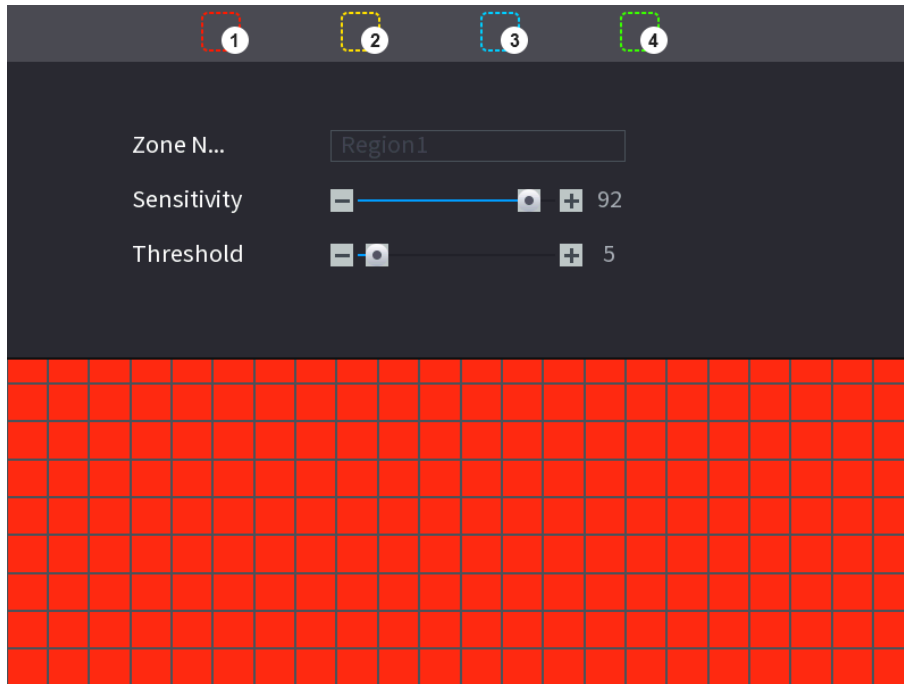

- 2) Select a region and set up the region name.  
The higher the sensitivity value is, the easier the motion detection is triggered; the lower the threshold is, the easier the motion detection is triggered. By default, the entire video images are covered by dynamic detection.

**NOTE**

Each color represents a certain region, you can set different motion detection areas for each region.

- 3) Drag the left button of the mouse, and select the area of the image to be detected, and set up its sensitivity and threshold value.

**NOTE**

Channel alarm events: As long as any one of the four regions triggers alarm, the channel that houses the region will give alarm.

- 4) Right-click on the screen.  
The **DETECT** interface is displayed.

Step 5 Configure the alarm linkage. See Table 4-12 for details.

Table 4-12 Description of Alarm Linkage

Linkage	Description	Reference chapters
Video Recording	When an alarm is triggered, the system starts recording by linking the record channel. After an alarm ends, the system stops recording after an extended time period according to the configured <b>Delay</b> .	See 4.5.1.2 Recording for details.

Linkage	Description	Reference chapters
Alarm Output	When an alarm is triggered, the system starts recording by linking the alarm output device. After an alarm ends, the alarm output stops after an extended time period according to the configured <b>Alarm Delay</b> .	See4.5.1.3Output for details.
Snapshot	When an alarm is triggered, the system starts snapshot by linking the channel.	See4.5.1.4Snapshot for details.
Tour	When an alarm is triggered, a tour of the selected channels is displayed on the local interface of the Device.	See4.5.1.5Tour for details.
Show Message	When an alarm is triggered, alarm message is displayed on the local interface.	See4.5.1.6Show for details.
Send Email	When an alarm is triggered, the system sends an alarm email to a designated recipient.	See4.5.1.7Sending for details.
Buzzer	When an alarm is triggered, the alarm buzzer beeps.	See4.5.1.8Buzzer for details.
System log	When an alarm is triggered, alarm message is recorded in the system log.	See4.5.1.9Log for details.

Step 6 Click **Save**.

## 4.5.1.2 Linking Recording

After recording is linked, the system starts recording by linking with the record channel when an alarm is triggered. After an alarm ends, the system stops recording after an extended time period according to the configured **Delay**.

### 4.5.1.2.1 Configuring Recording Schedule

After motion detection on the recording channel or alarm recording plan is enabled, the recording channel starts alarm linking with video recording.

Step 1 Select **Storage > Schedule > Record** under the main menu.

The **Record** interface is displayed. See Figure 4-33.

Figure 4-33 Record Plan

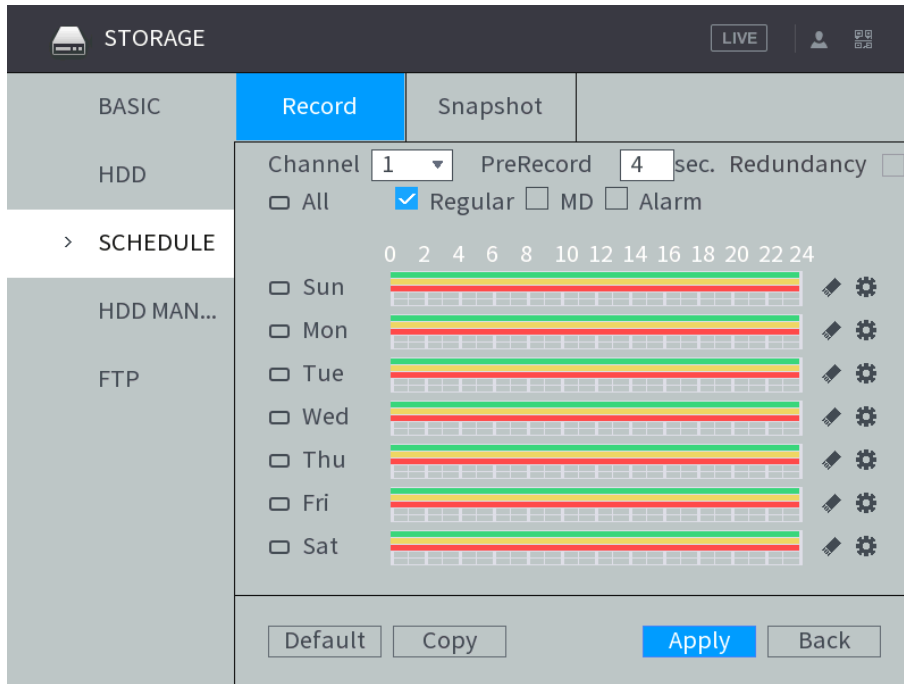

**Step 2** Select the channel number for linking recording.

**Step 3** Configure the recording time period and the recording type.

- 1) Click  corresponding to the week.

The **Time Period** interface is displayed. See Figure 4-34.

Figure 4-34 Time Period

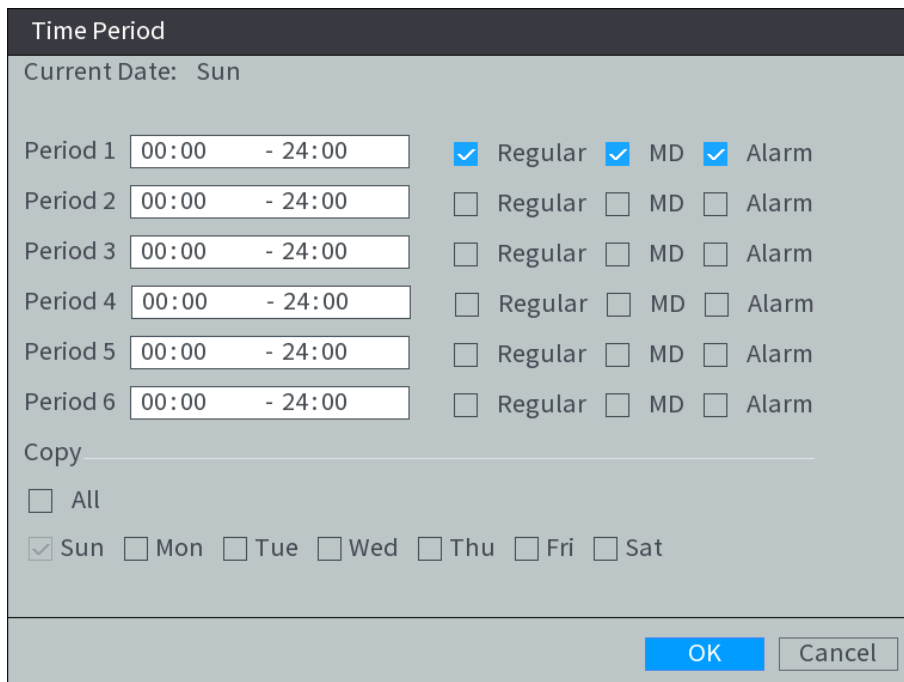

- 2) Select the record type and weekday, and enter the recording period. Configure the alarm type as needed, and select **Motion Detection** or **Alarm**.
  - ◇ To configure video detection linking with alarm recording (such as motion detection), select **Motion Detection**.
  - ◇ To configure other types of alarm linking with recording (such as local alarm), select **Alarm**.

3) Click **OK**.

The recording schedule appears on the **Record** interface to view the configured recording schedule directly.

Step 4 Click **Apply**.

#### 4.5.1.2.2 Enabling Automatic Recording

After automatic recording on the recording channel is enabled, the recording channel starts alarm linking with recording.

Step 1 Right-click **Manual > Record** on the homepage.

The **Record** interface is displayed.

Step 2 Enable automatic recording on the recording channel. See Figure 4-35.

Figure 4-35 Record

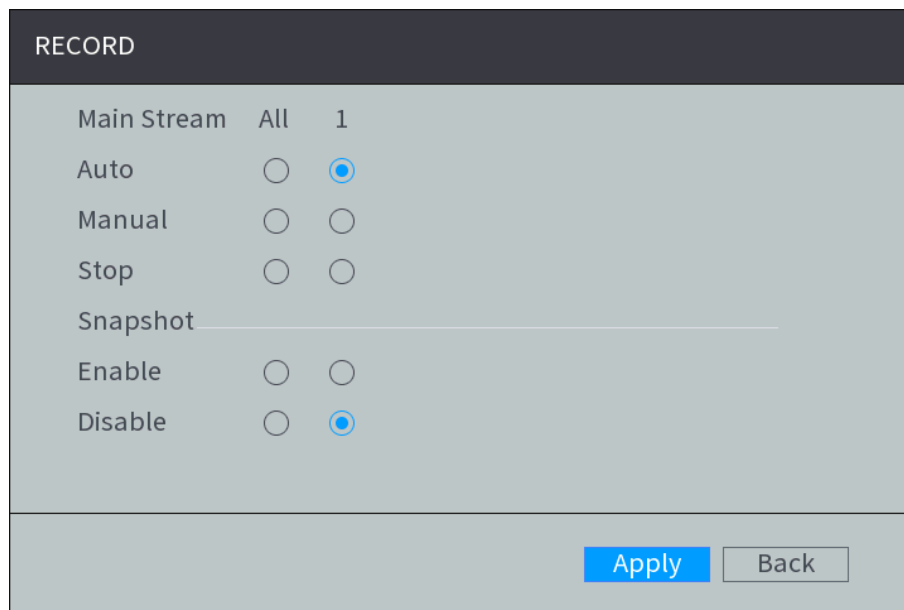

The screenshot shows a web interface titled "RECORD". It contains a table with recording options and two buttons at the bottom right: "Apply" and "Back".

	All	1
Main Stream		
Auto	<input type="radio"/>	<input checked="" type="radio"/>
Manual	<input type="radio"/>	<input type="radio"/>
Stop	<input type="radio"/>	<input type="radio"/>
Snapshot	_____	
Enable	<input type="radio"/>	<input type="radio"/>
Disable	<input type="radio"/>	<input checked="" type="radio"/>

Step 3 Click **Apply**.

#### 4.5.1.2.3 Configuring Recording Linkage

In the alarm configuration interface, configure alarm linking with recording and delay.

Step 1 Enter the alarm configuration interface, and select **Record Channel**. See Figure 4-36.



Figure 4-36 Record Channel

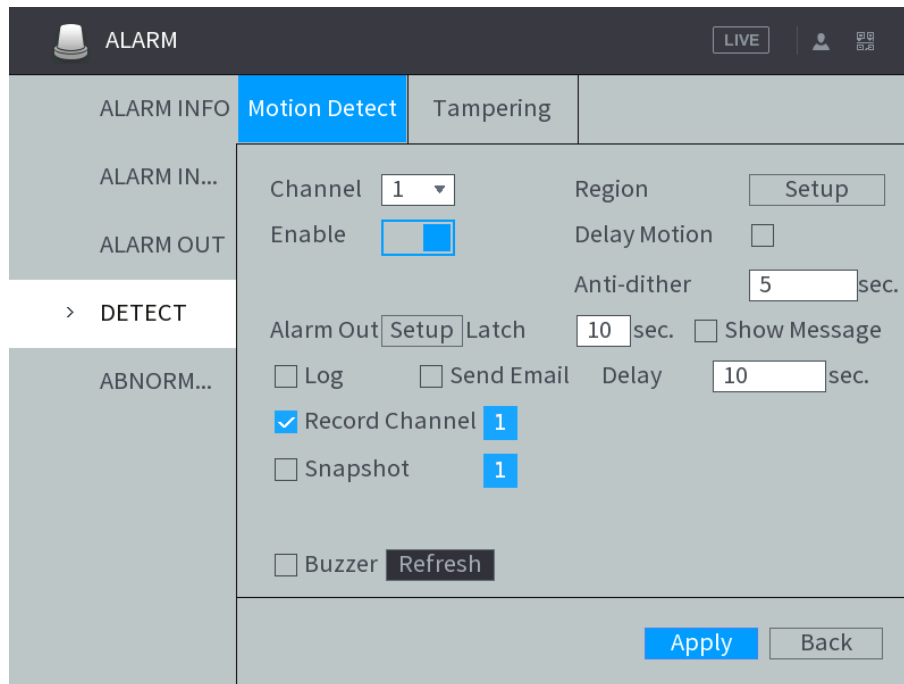

Step 2 Select the record channel.

Support multi-selection. One highlighted in blue means it is selected.

Step 3 Configure **Delay**.

#### 4.5.1.2.4 Result Verification

Take the configuration of motion detection on alarm linking with video recording as an example.

When an alarm is triggered, click  or click the record time period on the time shaft to play back alarm video after type, time, channel number, and record type are configured on the **Playback** interface.

#### 4.5.1.3 Linking Alarm Output

After alarm output is linked, the system gives an alarm by linking with the alarm output device when an alarm is triggered. After an alarm ends, the alarm stops after an extended time period according to the configured **Alarm Delay**.

#### Preconditions

The Device has been connected to the alarm output device, such as beeper, audible and visual alarm, etc.

#### Steps

Step 1 Enter the alarm configuration interface, click **Setting** of **Alarm Output**.

The Settings interface is displayed. See Figure 4-37.

Figure 4-37 Settings

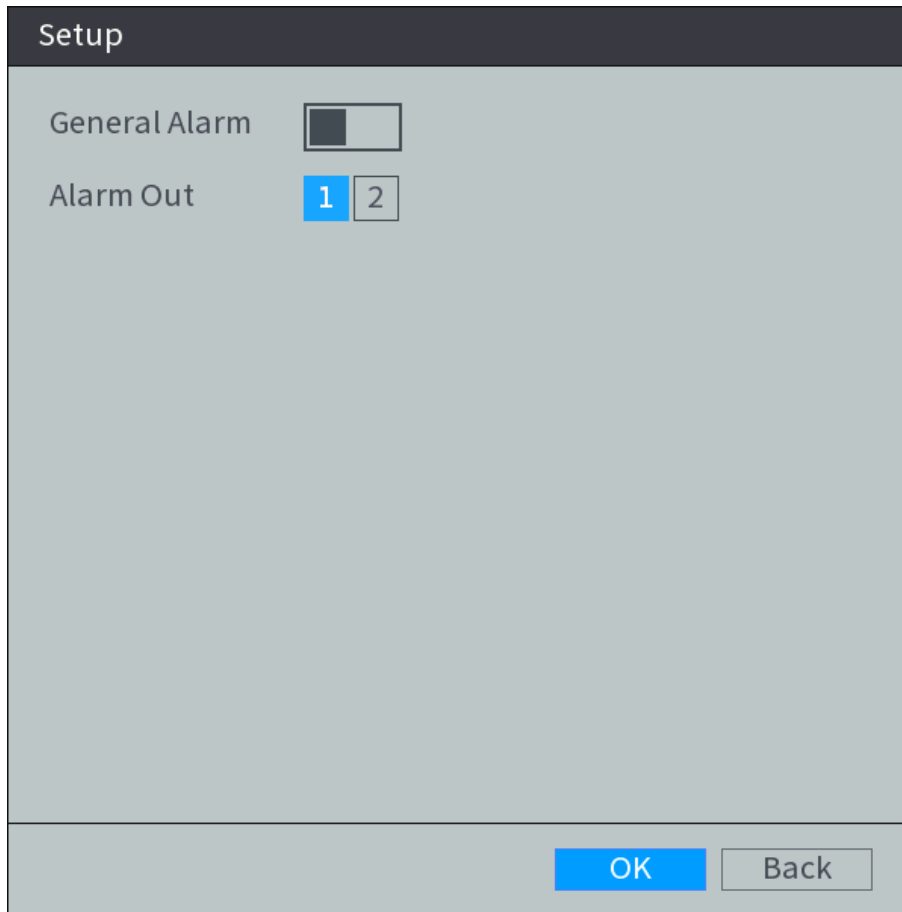

Step 2 Click  to enable the alarm output.

Step 3 Select a port for alarm output, and click **OK**.

Support multi-selection. One highlighted in blue means it is selected.

Step 4 Configure alarm output delay.

## Result Verification

When an alarm is triggered, the alarm output device gives an alarm, such as beep, light flashing, etc.

### 4.5.1.4 Linking Snapshot

After snapshot is linked, the system starts snapshot by linking the channel when an alarm is triggered.

#### 4.5.1.4.1 Configure snapshot schedule

After motion detection on channel or alarm snapshot plan is enabled, the channel starts alarm linking with snapshot.

Step 1 Select **Storage > Schedule > Snapshot** under the main menu.

The Snapshot interface is displayed. See Figure 4-38.

Figure 4-38 Snapshot

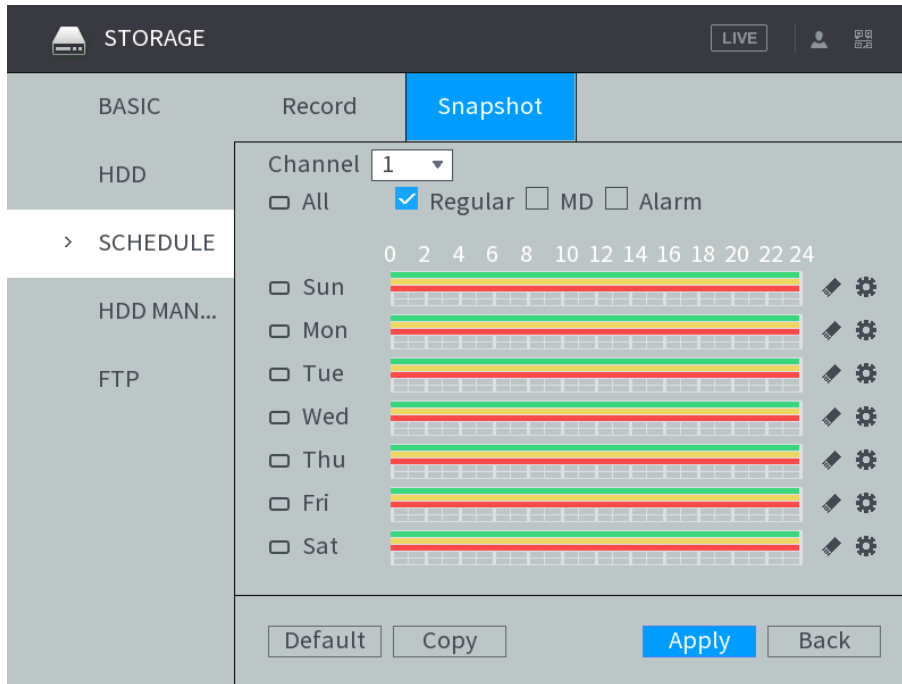

**Step 2** Select the channel number for linking snapshot.

**Step 3** Configure time period and type for snapshot.

- 1) Click  corresponding to the week.

The **Time Period** interface is displayed. See Figure 4-39.

Figure 4-39 Time Period

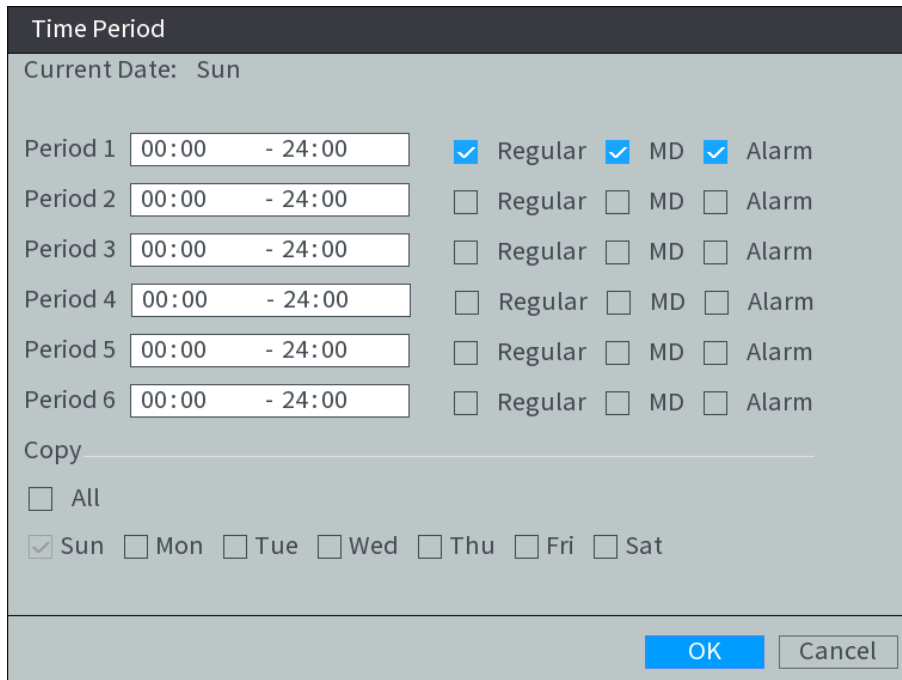

- 2) Select the snapshot type and weekday, and enter the period for taking snapshot. Configure the alarm type as needed, and select **Motion Detection** or **Alarm**.
  - ◇ To configure video detection linking with alarm video recording (such as motion detection), select **Motion Detection**.
  - ◇ To configure other types of alarm linking with video recording (such as local alarm), select **Alarm**.

3) Click **OK**.

Snapshot schedule appears on the **Snapshot** interface to view the configured snapshot schedule directly.

Step 4 Click **Apply**.

#### 4.5.1.4.2 Enabling Automatic Snapshot

After automatic snapshot on channel is enabled, the channel starts alarm linking with snapshot.

Step 1 Right-click **Manual > Record** on the homepage.

The **Record** interface is displayed.

Step 2 Enable the automatic snapshot on channel. See Figure 4-40.

Figure 4-40 Record

The screenshot shows a configuration window titled "RECORD". It contains a table with the following data:

	All	1
Main Stream		
Auto	<input type="radio"/>	<input checked="" type="radio"/>
Manual	<input type="radio"/>	<input type="radio"/>
Stop	<input type="radio"/>	<input type="radio"/>
Snapshot	_____	
Enable	<input type="radio"/>	<input type="radio"/>
Disable	<input type="radio"/>	<input checked="" type="radio"/>

At the bottom right of the window, there are two buttons: "Apply" (highlighted in blue) and "Back". A yellow rectangular box highlights the "Disable" row in the table.

Step 3 Click **Apply**.

#### 4.5.1.4.3 Configuring Snapshot Linkage

Step 1 Enter the alarm configuration interface, and select **Snapshot**. See Figure 4-41.

Figure 4-41 Snapshot

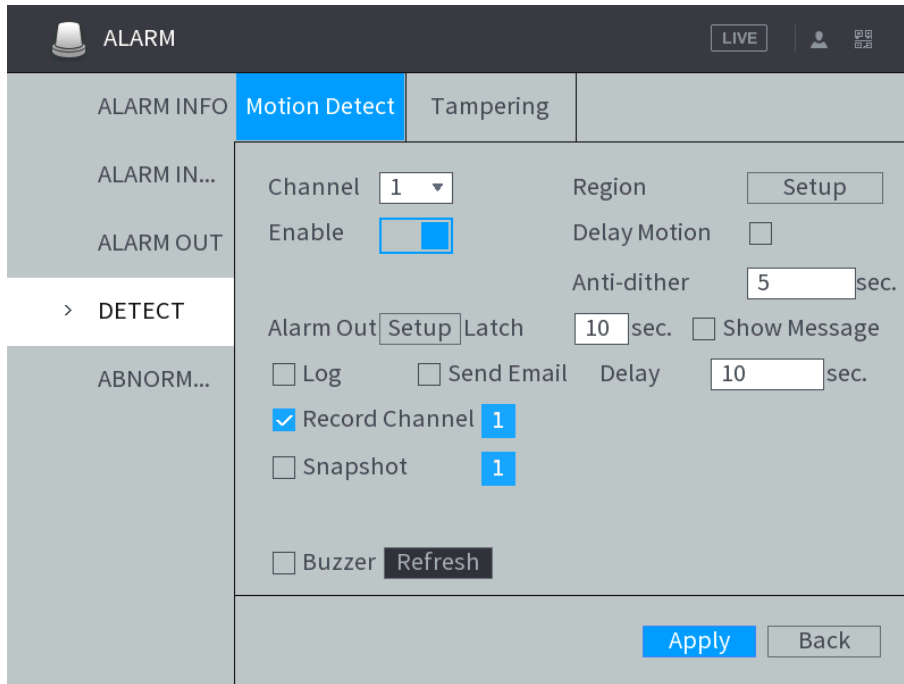

Step 2 Select the snapshot channel.

Support multi-selection. One highlighted in blue means it is selected.

#### 4.5.1.4.4 Result Verification

When an alarm is triggered, enter the local **Video Search** interface. After search condition is configured, click the snapshot time period on the time shaft to play alarm snapshots back.

#### 4.5.1.5 Linking Tour

After tour is linked, a tour of the selected channels is displayed on the local interface of the Device when an alarm is triggered.

### Steps

Step 1 Enter the alarm configuration interface, and select **Tour**. See Figure 4-42.

Figure 4-42 Tour

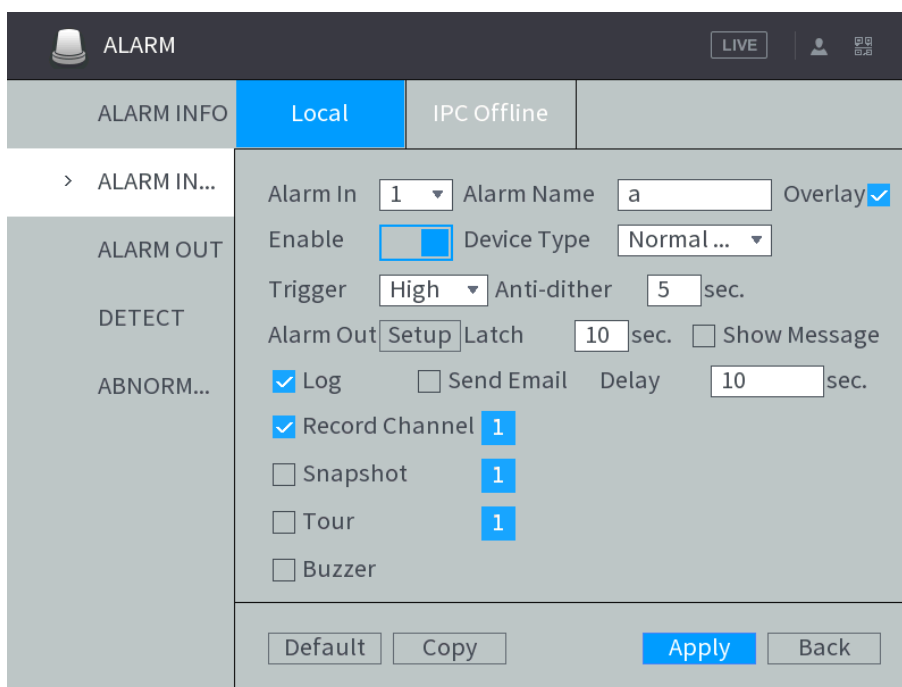

Step 2 Select the channel for tour.

Support multi-selection. One highlighted in blue means it is selected.

## Result Verification

When an alarm is triggered, a tour of the selected channels is displayed on the local interface in a form of single-window. After an alarm ends, the local interface returns to the window before alarm.

### 4.5.1.6 Linking Message Show

When an alarm is triggered, alarm message is displayed on the local interface after message display is linked.

## Steps

Enter the alarm configuration interface, and select **Message Show**. See Figure 4-43.

Figure 4-43 Show Message

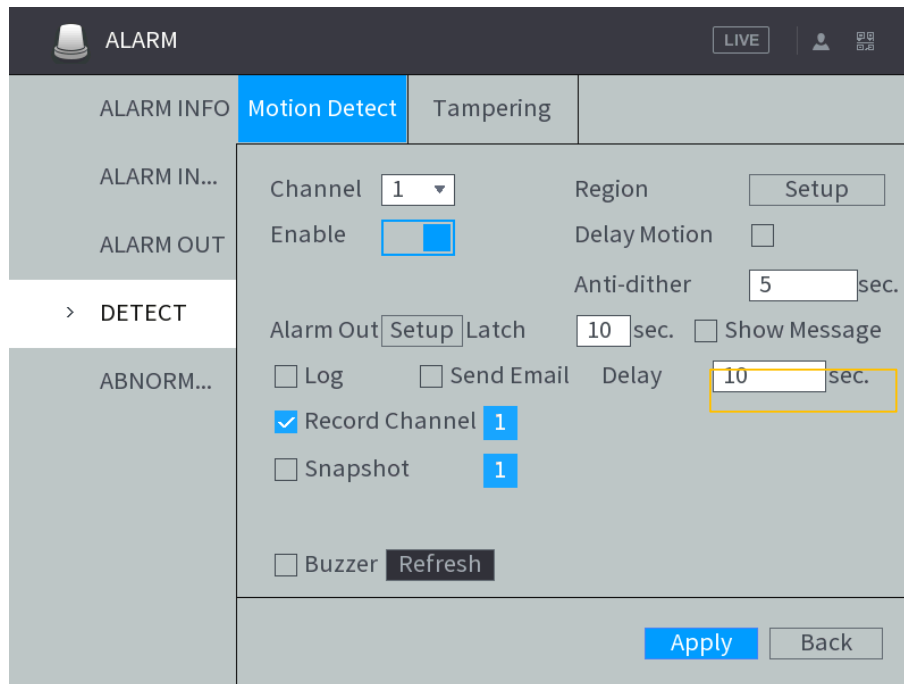

## Result Verification

Take the configuration of motion detection on alarm linking with screen output as an example. When an alarm is triggered, the **Alarm Status** interface is displayed on the local interface of the Device.

### 4.5.1.7 Linking Email Sending

After Email sending is linked, the system sends an alarm email to a designated recipient when an alarm is triggered.

#### 4.5.1.7.1 Configuring Email Settings

The alarm linking with mail sending is effective only when the email address, recipient and other information are configured.

Step 1 Select **NETWORK > EMAIL**.

The **EMAIL** interface is displayed. See Figure 4-44.

Figure 4-44 Email

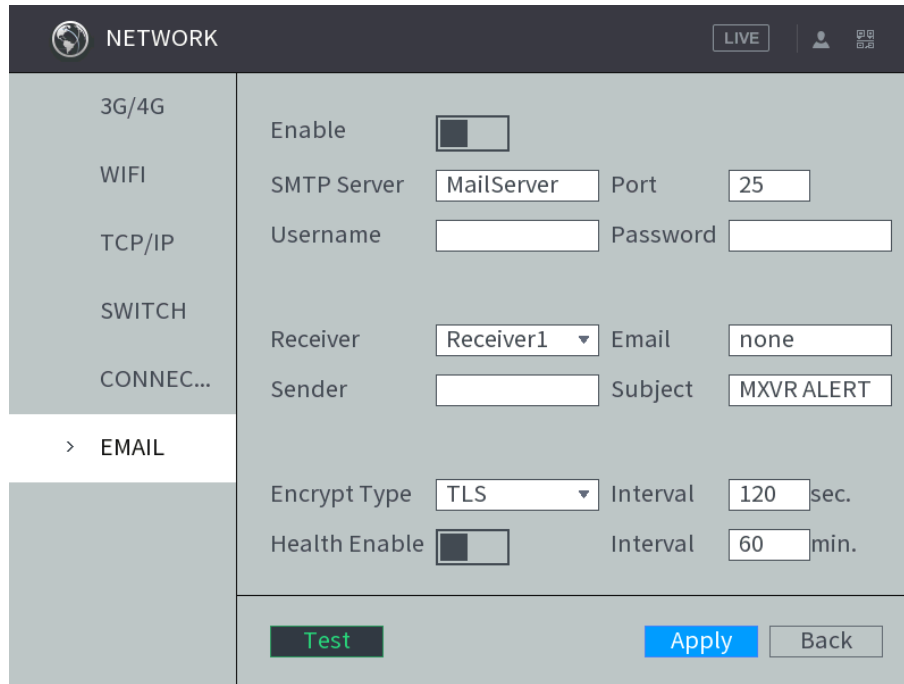

**Step 2** Click  to enable email function.

**Step 3** Configure TCP/IP parameters. For details, see Table 4-13.

Table 4-13 Email setting parameters description

Name	Description
SMTP Server	Configure the address of SMTP (Simple Mail Transfer Protocol) server.
Port	Enter the port value of SMTP server.
Username	Enter the user name and password of SMTP server.
Password	
Receiver	Receiver's mail address You can enter up to three email addresses separated by colons
Sender	Select sender, and configure email address.
Email	
Title	You can enter no more than 63 characters in Chinese, English, and Arabic numerals
Encrypt	In the Encrypt list, select an encryption type from NONE, SSL, and TLS.
Interval	<p>This is the interval that the system sends an email for the same type of alarm event, which means, the system does not send an email upon any alarm event</p> <p>The interval ranges from 0 to 3600 seconds. 0 means that there is no interval</p> <p> <b>NOTE</b></p> <p>This setting helps to avoid the large amount of emails caused by frequent alarm events</p>



Name	Description
Health Enable	<p>The system sends test mail to check if the connection is successfully set up</p> <p>Select the <b>Health Enable</b> check box, and then enter the interval. The system can send a test email to check the connection after the specified interval</p> <p> <b>NOTE</b></p> <p>The value ranges from 30 minutes to 1440 minutes</p>

**Step 4** Click **Apply**.

Click **Test** to test if emails can be sent out and received as intended after configuration. If the configuration is correct, you would receive test email.

#### 4.5.1.7.2 Configuring Email Linkage

Enter the alarm configuration interface, and select **Send Email**. See Figure 4-45.

Figure 4-45 Mail sending

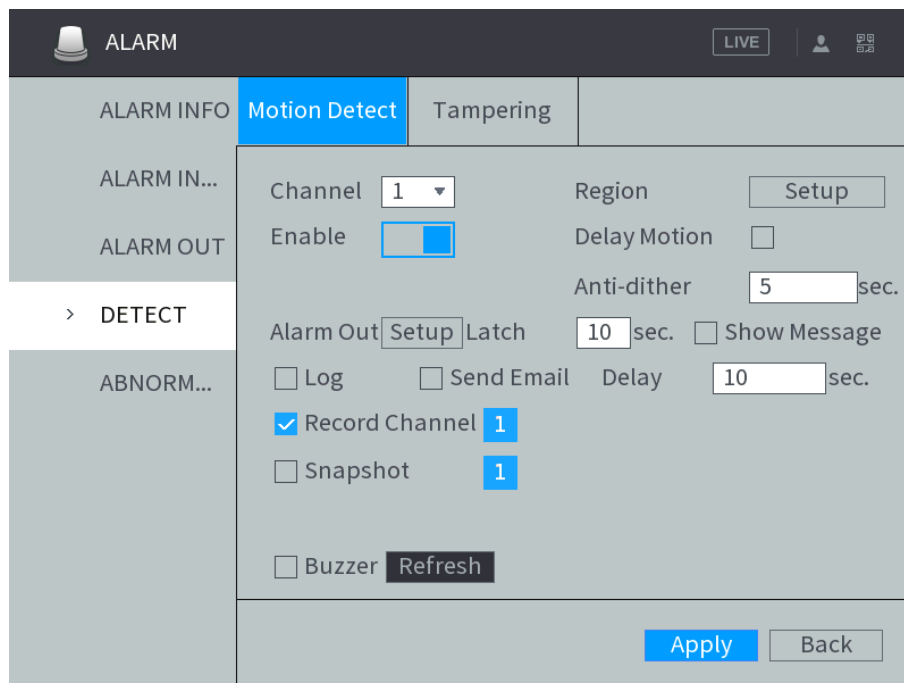

#### 4.5.1.7.3 Result Verification

When an alarm is triggered, the system sends an alarm email to a designated recipient.

#### 4.5.1.8 Linking Buzzer

After a buzzer is linked, the alarm buzzer beeps when an alarm is triggered.

#### Steps

Enter the alarm configuration interface, and select **Buzzer**. See Figure 4-46.

Figure 4-46 Buzzer

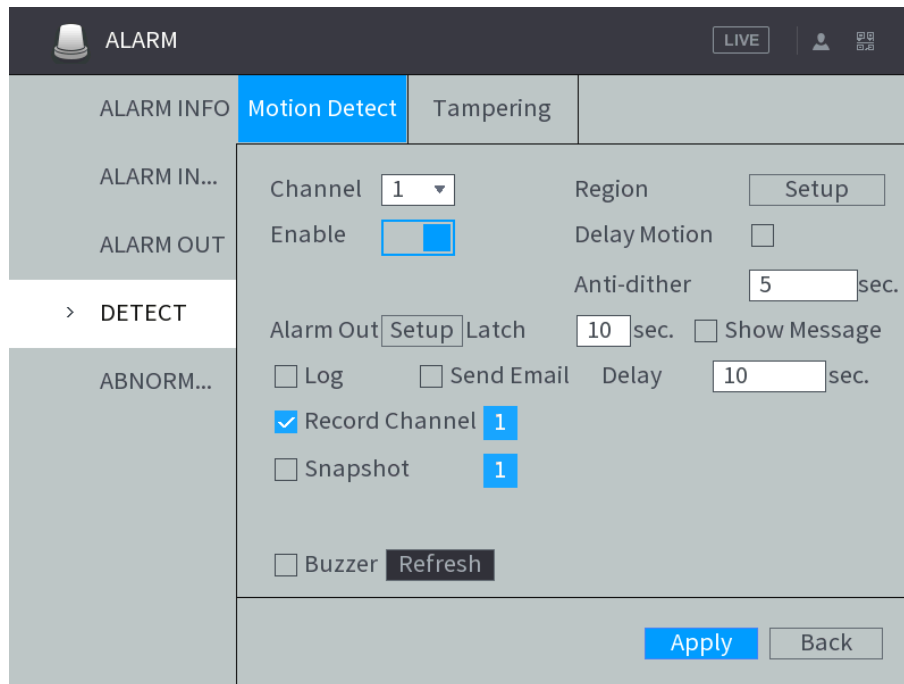

## Result Verification

When an alarm is triggered, the Device beeps.

### 4.5.1.9 Linking Log

After log is linked, alarm message is recorded in the system log when an alarm is triggered.

## Steps

Enter the alarm configuration interface, and select **System Log**. See Figure 4-47.

Figure 4-47 System log

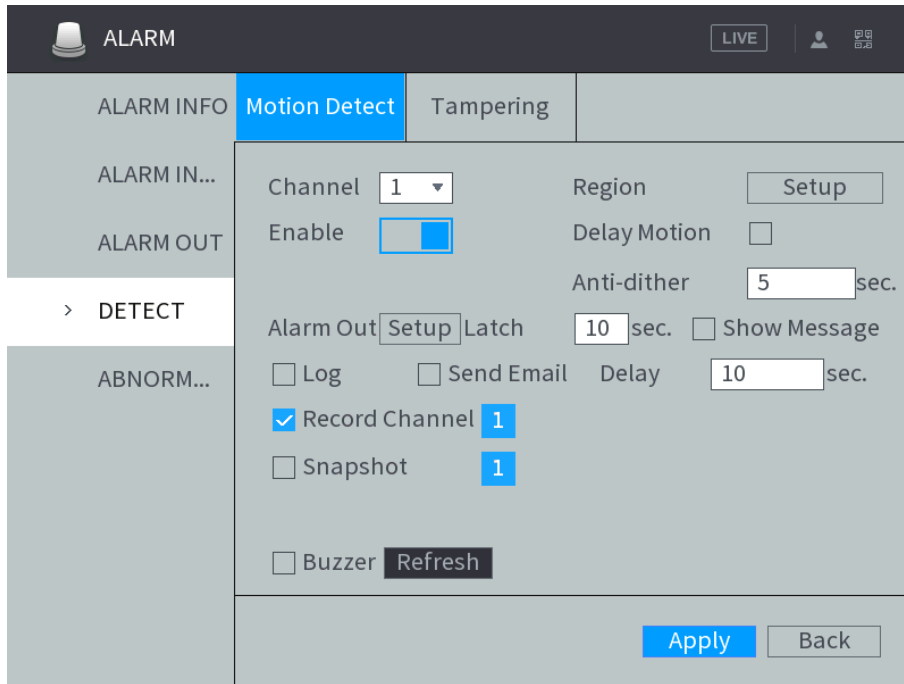

## Result Verification

When an alarm is triggered, select **Alarm > Alarm Information**, and configure type, start time, end time, and researchable alarm log information. See Figure 4-48.

Figure 4-48 Alarm Log

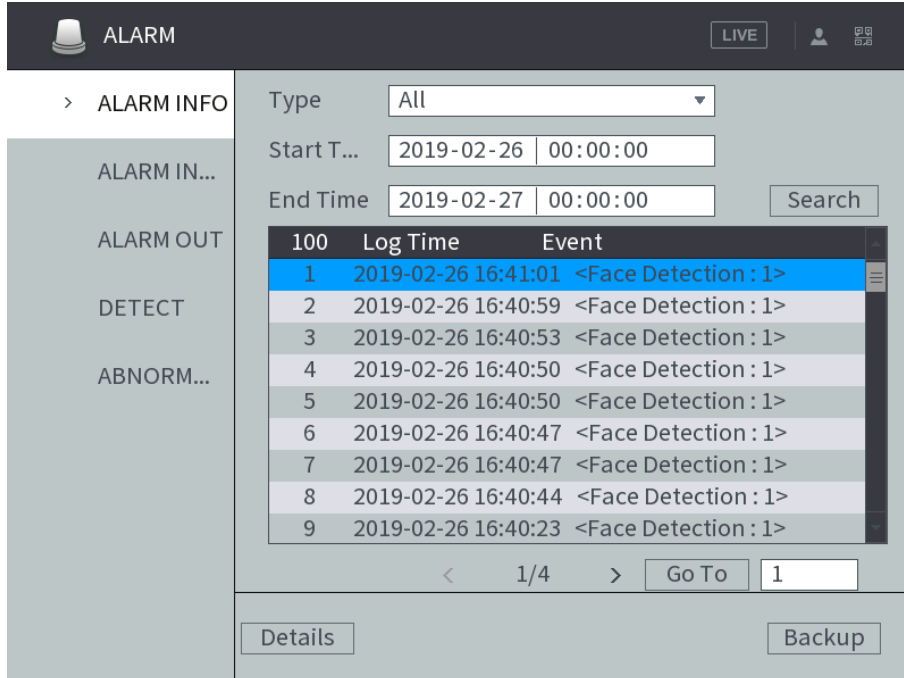

## 4.5.2 Configuring Video Detection Settings

Check whether any change with a certain level occurs or not by analyzing video images. If a change with a certain level occurs in an image (such as object moving, fuzzy image, etc.), the system starts alarm linkage.

### 4.5.2.1 Video Detection

After the motion detection is configured, the system starts alarm linkage when a mobile object occurs in the monitoring screen and the moving speed reaches the preset sensitivity.

See 4.5.1 Alarm for details.

### 4.5.2.2 Configuring Tampering

After tampering is configured, the system starts alarm linkage when the monitoring screen is blocked by an object, causing the monitoring screen outputting single-color images.

**Step 1** In the main menu, select **Alarm > Detection > Tampering**.

The **Tampering** interface is displayed. See Figure 4-49.

Figure 4-49 Video tampering

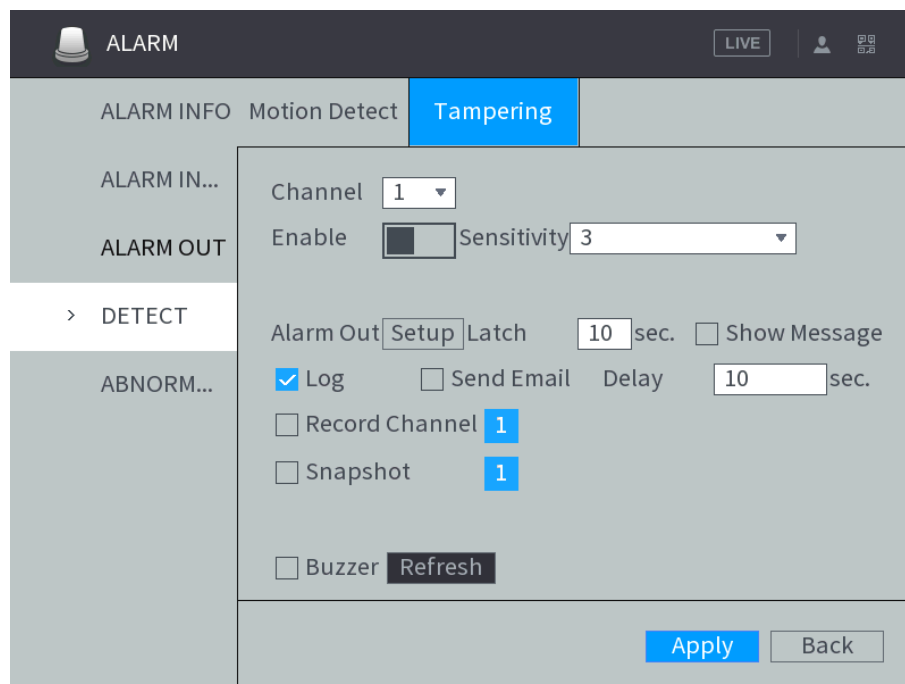

**Step 2** Select the channel number, and click  to enable the tampering for the channel.

**Step 3** Configure the sensitivity.

The higher the sensitivity value is, the easier the mobile object detection is triggered. The possibility of false alarm also increases.

**Step 4** Configure the alarm linkage action. See 4.5.1 Alarm for details.

**Step 5** Click **Apply**.

### 4.5.3 Configuring Alarm Events Settings

Configure the alarm event detection. When the preset alarm rule is triggered, the system starts alarm linkage. Alarm event types include local alarm and IPC offline alarm depending on different alarm input.

- Local alarm: When the alarm input port of the Device is connected to the alarm device, and when the alarm signal is transferred to the Device through the alarm input port, the

system starts alarm linkage after the local alarm is configured.

- IPC offline alarm: When network connecting the Device with IPC is off, the system starts alarm linkage.

**Step 1** In the main menu, select **Alarm > Alarm Input**.

The **Alarm Input** interface is displayed. See Figure 4-50.

Figure 4-50 Alarm Input

The screenshot shows the 'ALARM' configuration page. The 'Local' tab is active. The configuration includes: Alarm In (1), Alarm Name (a), Overlay (checked), Enable (checked), Device Type (Normal...), Trigger (High), Anti-dither (5 sec), Alarm Out (Setup), Latch (10 sec), Show Message (unchecked), Log (checked), Send Email (unchecked), Delay (10 sec), Record Channel (1), Snapshot (1), Tour (1), and Buzzer (unchecked). Buttons for Default, Copy, Apply, and Back are at the bottom.

**Step 2** Click each alarm event tab, and enable the alarm input or channel.

- Local alarm: The local alarm is enabled by default. Select alarm input, and configure the alarm name.
- IPC offline alarm: The IPC offline alarm is enabled by default. Select channel number, and configure the alarm name.

**Step 3** Configure alarm event parameters

When the local alarm and the IPC offline alarm are enabled, configure **Anti-dither** and **Device Type**.

- Anti-dither: After the anti-dither time is configured, the system records only one alarm event during this period.
- Device type: Select the device type of the external alarm device, normally open and normally closed.

**Step 4** Configure the alarm linkage action. See 4.5.1 Alarm for details.

**Step 5** Click **Apply**.

## 4.5.4 Abnormality

Configure abnormal event alarm detection. When there is any abnormality occurs in hard disk or network, the system starts alarm linkage.

**Step 1** In the main menu, select **Alarm > Abnormal**.

The **ABNORMAL** interface is displayed. See Figure 4-51.

Figure 4-51 Abnormality

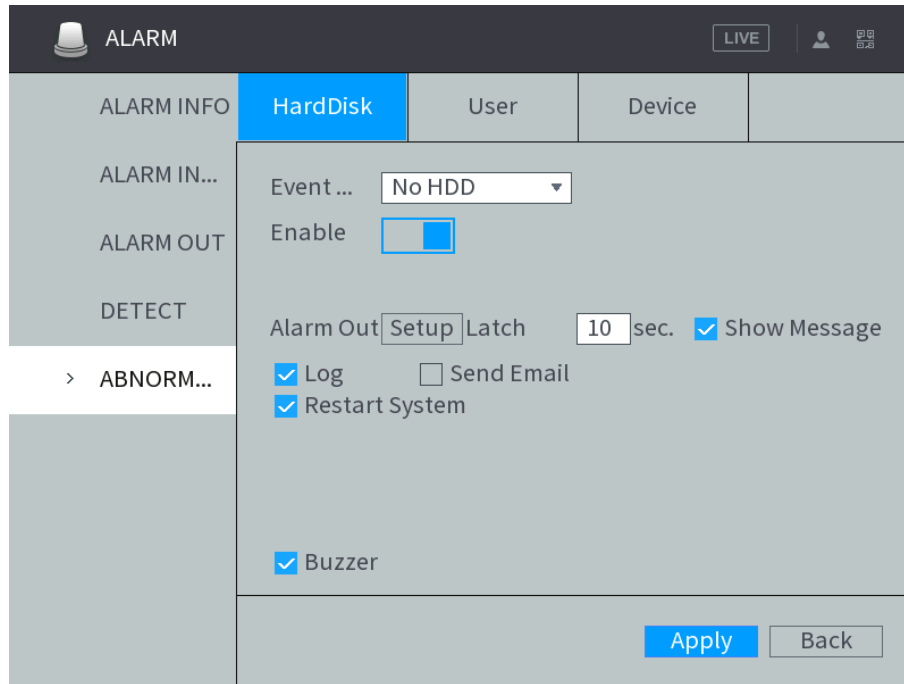

**Step 2** Click each abnormal event bar, and select **Event Type**.

- Hard Disk: Configure abnormal event alarm detection for hard disk, including No HDD, HDD Error, HDD No Space.
- User: Configure abnormal event alarm detection for illegal login.
- Device: Configure abnormal event alarm detection for device, including low battery, temperature too high, rollover, collision, over speed and low speed.

**Step 3** Enable abnormal event alarm detection.

- Abnormal event alarm detection for hard disk and user is enabled by default. Keep the default.
- For abnormal event alarm detection for device, click  to enable abnormal event alarm detection.

**Step 4** Configure abnormality parameters. For the detailed description, see Table 4-14.

Table 4-14 Abnormal event setting parameters description

Name	Description
Attempt(s)	If <b>Illegal Login</b> is selected, configure this parameter. In the Attempt(s) box, enter the maximum number of allowed password input errors. If the number of password input errors reaches this value, the user account will be locked.
Lock Time	If <b>Illegal Login</b> is selected, configure this parameter. Set up the lock time for the locked user account when the number of password input errors reaches this value.
Ceiling temperature	If <b>Temperature Too High</b> is selected, configure this parameter. Enter the upper limit of device temperature. The alarm is triggered when the device temperature exceeds this value.
Less Than	If <b>Battery Low Voltage</b> is selected, configure this parameter.

Name	Description
Accumulator voltage	In the Battery Voltage boxes, enter the minimum percentage of supply voltage and supply voltage to the device from the vehicle. When the vehicle is in ACC Off, the voltage supplied to the device is lower than the preset minimum percentage, the system generates an alarm
Max Speed	If Over Speed is selected, configure this parameter The upper limit of vehicle speed. When the vehicle speed exceeds this value, the system generates an alarm
Min Speed	If Low Speed is selected, configure this parameter The lower limit of vehicle speed. When the vehicle speed is lower than this value, the system generates an alarm

**Step 5** Configure the alarm linkage action. See 4.5.1 Alarm for details.

When **Restart System** is enabled, the system detects no HDD and restarts after 3 minutes.

**Step 6** Click **Apply**.

## 4.5.5 Configuring Alarm Output Settings

Configure the alarm port output type of the Device, including auto, manual, and stop. When the alarm output port is connected to the alarm device, and alarm is linked with alarm output function, configure the alarm type as **Auto**. Then the system starts alarm linkage.

**Step 1** In the main menu, select **Alarm > Alarm Output**.

The **Alarm Out** interface is displayed. See Figure 4-52.

Figure 4-52 Alarm Output

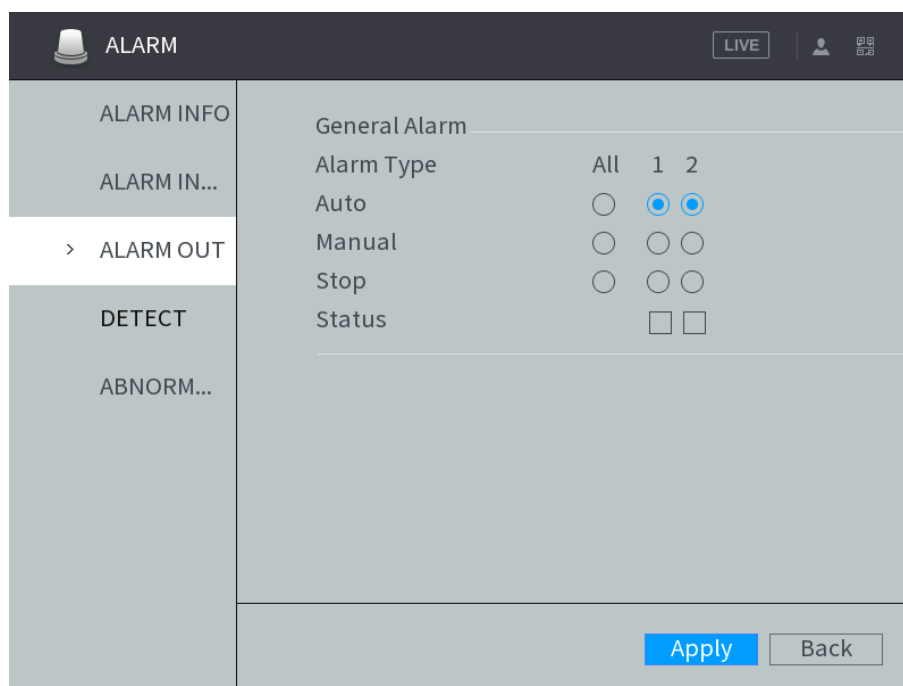

**Step 2** Select alarm output mode.

- **Manual:** After the alarm linkage is configured, no matter whether there is an alarm event occurs, the corresponding alarm output port keeps generating alarm.
- **Auto:** After the alarm linkage is configured, when an alarm event occurs, the corresponding alarm output port generates alarm.

- Stop: After the alarm linkage is configured, no matter whether there is an alarm event occurs, the corresponding alarm output port never generate alarm.

**Step 3** Click **Apply**.

View status of all alarm output ports under **Status**.

## 4.5.6 Searching Alarm Log

Search alarm log within a time period.

**Step 1** In the main menu, select **Alarm > Alarm Information**.

The Alarm Information interface is displayed.

**Step 2** Configure type, start time and end time.

**Step 3** Click **Search**.

The alarm information satisfying the searching conditions are displayed. See Figure 4-53.

- To view detailed alarm information, select it and click **Details**.
- After the Device is connected to an external storage device, click **Backup** to backup alarm information to the external storage device.

Figure 4-53 Alarm information

The screenshot shows the 'ALARM' interface with a 'LIVE' indicator and user profile icons. The left sidebar contains navigation options: 'ALARM INFO', 'ALARM IN...', 'ALARM OUT', 'DETECT', and 'ABNORM...'. The main area has search filters: 'Type' set to 'All', 'Start Time' set to '2019-02-26 00:00:00', and 'End Time' set to '2019-02-27 00:00:00'. A 'Search' button is present. Below the filters is a table of alarm events:

100	Log Time	Event
1	2019-02-26 16:45:24	<Face Detection : 1>
2	2019-02-26 16:45:21	<Face Detection : 1>
3	2019-02-26 16:44:23	<Face Detection : 1>
4	2019-02-26 16:44:21	<Face Detection : 1>
5	2019-02-26 16:43:29	<Face Detection : 1>
6	2019-02-26 16:43:26	<Face Detection : 1>
7	2019-02-26 16:43:23	<Face Detection : 1>
8	2019-02-26 16:43:21	<Face Detection : 1>
9	2019-02-26 16:42:28	<Face Detection : 1>

Below the table, there are navigation controls: '< 1/4 >' and a 'Go To' button with the value '1'. At the bottom, there are 'Details' and 'Backup' buttons.

## 4.6 System config

### 4.6.1 Configuring Camera



The interface might be different depending on the model you purchased.



## 4.6.1.1 Configuring Encode Parameters

### 4.6.1.1.1 Configuring Video Streaming

You can set up some video stream parameters, including Stream Type, Encode Mode, Resolution, and more depending on the actual network bandwidth.

**Step 1** In the main menu, select **Camera > Encode Setting > Encode**.

The **Video Stream** screen appears. See Figure 4-54.

Figure 4-54 Video Stream

**Step 2** Select channel, and configure parameters. For details, see Table 4-15.

Table 4-15 Encode setting parameters description

Name	Description
Record Type	The record type is permanently fixed as general and cannot be changed. For general record, motion detection and alarm, general stream is configured for recording.
Encode Mode	Encode Mode of video
Smart Code	After the smart code is enabled, reduce the bit rate value. <b>NOTE</b> <ul style="list-style-type: none"> <li>Only some models support Smart Code.</li> <li>After the smart code is modified, restart IPC. Some IPC functions (such as smart analysis, ROI, SVC, corridor pattern, and more) will be invalid. Proceed with caution.</li> </ul>
Resolution	The higher the video resolution, the better the image quality
Frame Rate (FPS)	Configure the frames per seconds for video. The higher the value, the smoother and more vivid the image

Name	Description
Stream Ctrl	<p>You can select bit rate type</p> <ul style="list-style-type: none"> <li>● CBR: Constant Bit Rate, which changes around the configured value</li> <li>● VBR: Variable Bit Rate, which changes along with environment</li> </ul> <p> <b>NOTE</b></p> <p>It is recommended to select CBR when there might be only small changes in the monitoring environment, and select VBR when there might be big changes in the monitoring environment</p>
Bit Rate	<p>Configure the encode value for main stream and sub stream</p> <ul style="list-style-type: none"> <li>● When CBR is selected, select the bit rate according to the reference bit rate, and the bit rate changes along the configured value</li> <li>● When VBR is selected, select the upper limit value of bit rate according to the reference bit rate, and the bit rate changes along with the monitoring environment. But the maximum bit rate value changes around the configured value</li> <li>● Select <b>Customized</b>, and you can configure bit rate value manually</li> </ul>
Quality	<p>This parameter can be set only when <b>Stream Ctrl</b> is set to <b>BRC_VBR</b>.</p> <p>Select the image quality level. The higher the value, the better the image will become</p>
Bit Stream	<p>The system recommends the optimal bit rate range according to the resolution and frame rate settings</p>
More	<p>Click <b>More</b> to enable audio encode and select audio format. Audio formats include G711a, PCM, G711u and AAC</p>

Step 3 Click **Apply**.

#### 4.6.1.1.2 Configuring Snapshot Streaming

Configure parameters for different types of snapshots, including quality, frequency, etc.

Step 1 In the main menu, select **Camera > Encode Setting > Snapshot**.

The **Snapshot Stream** screen appears. See Figure 4-55.

Figure 4-55 Snapshot Stream

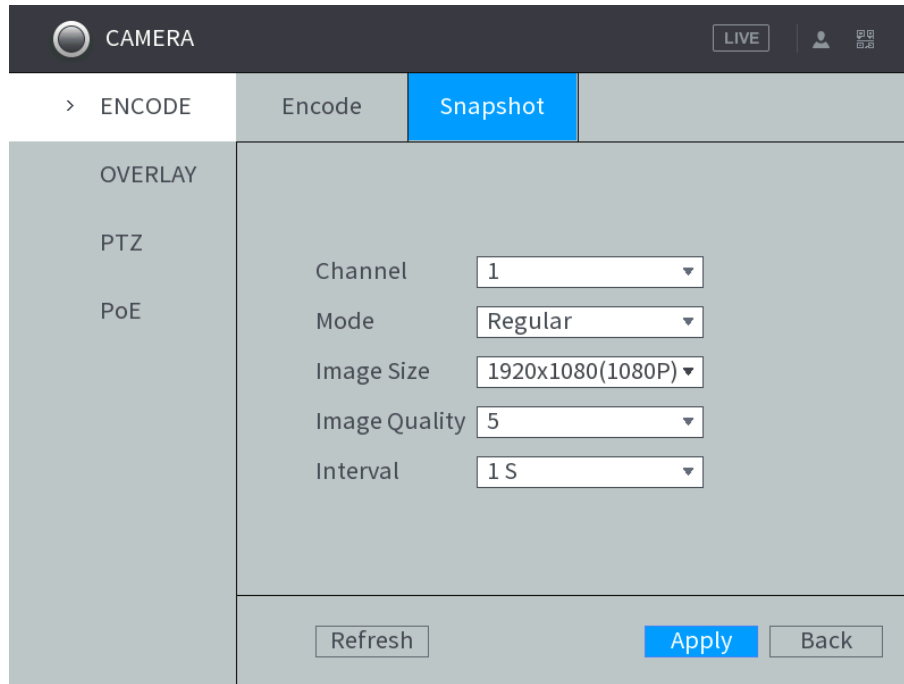

**Step 2** Configure TCP/IP parameters. For details, see Table 4-16.

Table 4-16 Snapshot setting parameters description

Name	Description
Channel	Select the corresponding channel number.
Snap Mode	Includes timing and events <ul style="list-style-type: none"> <li>Timing: Take a snapshot within the configured period</li> <li>Event: Take a snapshot when there is an alarm triggered, such as local alarm, video detection and abnormality.</li> </ul>
Size	Select a resolution for the captured image. <ul style="list-style-type: none"> <li>If analog channel is selected, select according to actual condition.</li> <li>If digital channel is selected, the resolution is the same with the main stream and cannot be modified.</li> </ul>
Quality	Configures the image quality by 6 levels
Interval	Interval of taking snapshots Select <b>Customized</b> to configure the snapshot interval for manually capturing snapshots. The maximum value you can set is 3600 seconds as an interval between two snapshots

**Step 3** Click **Apply**.

#### 4.6.1.2 Configuring Video Overlay

Configure the time overlay and channel overlay on the monitoring screen.

**Step 1** In the main menu, select **Camera > Overlay**.

The **Superposition Coding** interface is displayed. See Figure 4-56.

Figure 4-56 Superposition Coding

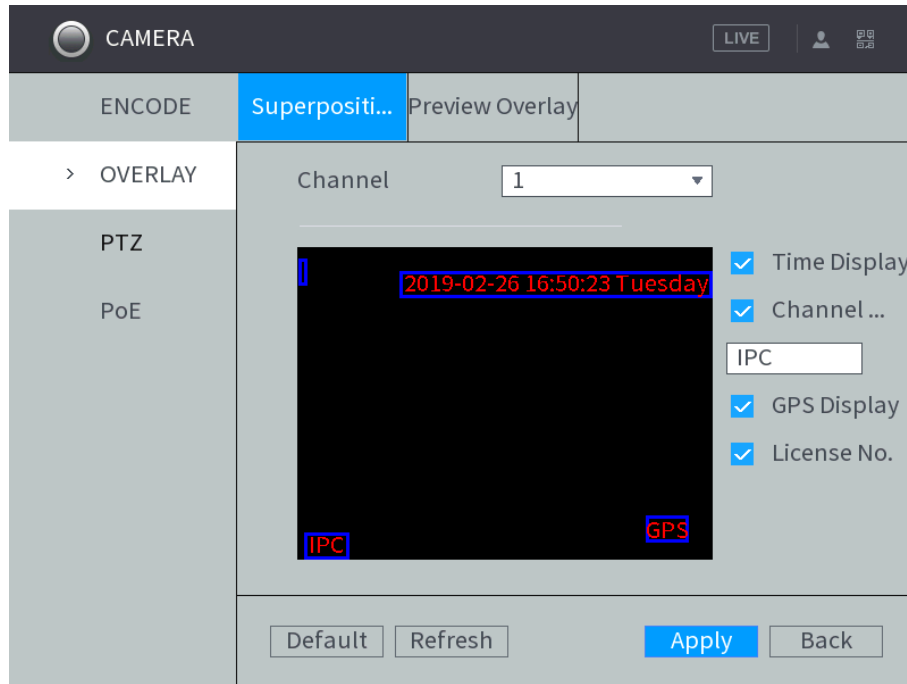

**Step 2** Select **Superposition Coding** or **Preview Overlay** according to overlay information.

- In the **Superposition Coding** interface, select channel to overlay the time display, channel display, GPS display and license no. display in video images. You can customize the channel display.
- In the **Preview Overlay** interface, overlay channel display and GPS display.

**Step 3** Click **Apply**.

### 4.6.1.3 Configuring PoE

Review the connection status of the PoE port and reset the camera.

Select **Camera > PoE** in the main menu. The **PoE** interface is displayed. See Figure 5-49.

Click  to turn on PoE reset function, and click **Apply** to reset the camera with power but offline so that the camera can be online. If the camera is still offline after reset for 3 times, the system will not reset again.

When the total power of the cameras accessed through PoE exceeds the maximum power of the device, the device will force the camera connected to the maximum port number to go offline until the total power of the camera accessed through PoE does not exceed the maximum power of the device.

Figure 4-57 PoE

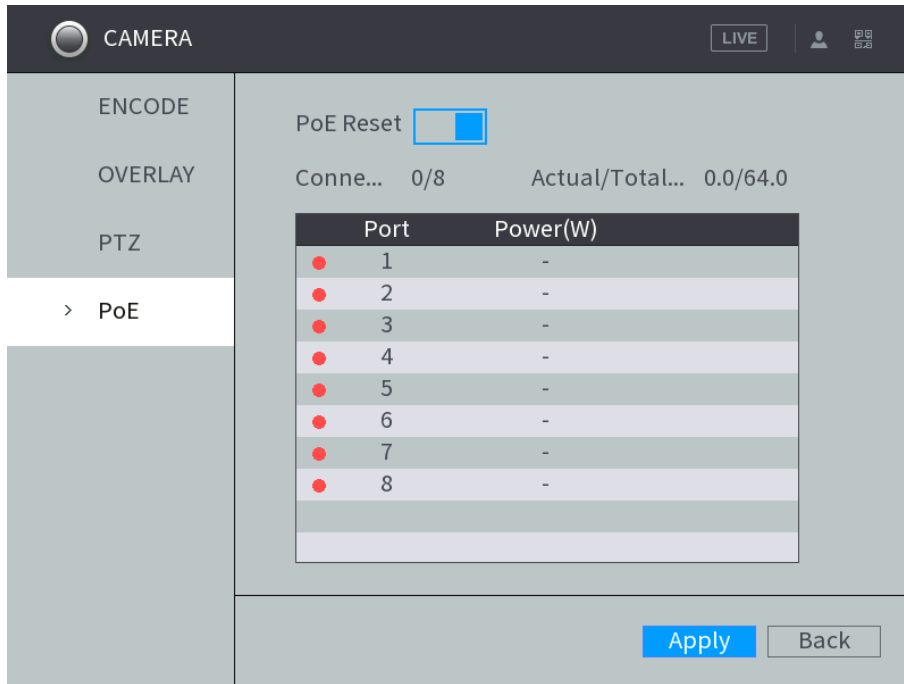

## 4.6.2 Network Parameters Configuration

### 4.6.2.1 Connection Setting

Set the port for simultaneous access to the device through Clients ( including WEB clients, platform clients, mobile phone clients, etc.).

**Step 1** Select **Main Menu > NETWORK > CONNECTION SETTING**.

The **Connection Setting** interface is displayed. See Figure 4-58.

Figure 4-58 Port

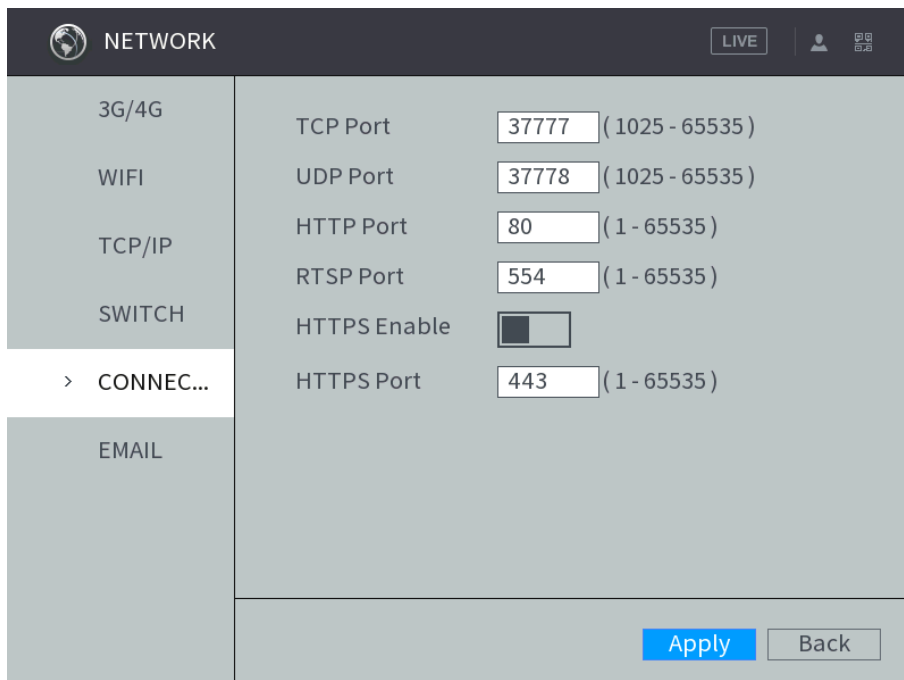

**Step 2** Configure the port parameters of the device. For details, see Table 4-17.

 **NOTE**

The revised settings take effect after reboot. Proceed with caution.

Table 4-17 Connection setting parameters description

Name	Description
TCP Port	Transmission Control Protocol port, the value is 37777 by default
UDP Port	User Datagram Protocol. The default value setting is 37778. You can enter the value according to your needs
HTTP Port	Hyper Text Transfer Protocol port. The default setting is 80. You can enter the value according to your actual situation, and in this case, add the modified value after the address when logging the Device on the browser
HTTP S Port	Hyper Text Transfer Protocol over Secure Socket Layer port. Click  , and then enter the value according to your actual situation. The default setting is 443.
RSTP Port	<ul style="list-style-type: none"> <li>Real Time Streaming Protocol port, leave it if the value is 554 by default. If you use Apple browser QuickTime or VLC to play the real-time monitoring screen, the following formats can be used: This function is also available for Blackberry</li> <li>When the URL format requiring RTSP, you need to specify channel number and bit stream type in the URL, and also user name and password if needed</li> <li>When playing live view with Blackberry smart phone, you need to turn off the audio, and then set the code mode to H.264B and resolution to CIF</li> </ul> <p>URL format example  Rtsp://&lt;user name&gt;:&lt;password&gt;@&lt;IP address&gt;:&lt;port&gt;/cam/realmonitor?channel=1&amp;subtype=0</p> <ul style="list-style-type: none"> <li>Username, such as admin</li> <li>Password: For example, admin_123</li> <li>IP address: For example, 192.168.1.16</li> <li>Port: The default setting is 554. If the default setting is displayed, you do not need to configure this parameter</li> <li>Channel: Refers to the Channel number, starting from 1 For example, if it is channel 2, then enter channel=2</li> <li>Subtype refers to Bit stream type; 0 means main stream (Subtype=0) and 1 means sub stream (Subtype=1)</li> </ul> <p>So, if you require the sub stream of channel 2 from a certain device, then the URL should be  rtsp://admin:admin_123@192.168.1.16:554/cam/realmonitor?channel=2&amp;subtype=1</p> <p>If certification is not required, there's no need to specify the username and password. Use the following format  rtsp:// &lt;IP address &gt;: &lt;port&gt;/cam/realmonitor?channel=1&amp;subtype=0</p>

**Step 3** Click **Apply**.

## 4.6.2.2 Configuring Wireless Network

You can connect the Device to the Internet through Wi-Fi. Make sure the Device can communicate with other devices in the network diagram. The Device itself can also act as a hot spot to share flows with other terminals.

### NOTE

If both 3G/4G and Wi-Fi are available, the Device connects to Wi-Fi and disconnected from 3G/4G.

### 4.6.2.2.1 Switching Mode

Step 1 Select **Main Menu > NETWORK > WIFI > Mode Switch**.

The **Mode Switch** interface is displayed. See Figure 4-59.

Figure 4-59 Mode switch

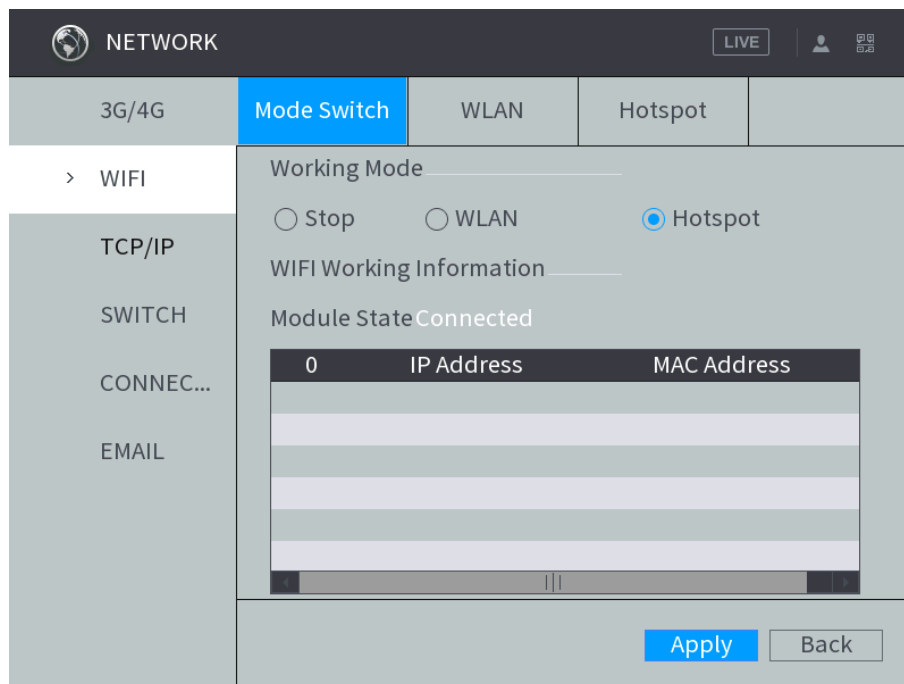

Step 2 Select the working mode.

- When the device needs to be connected to Wi-Fi, select **WLAN** as the working mode.
- When the device needs to be used as a hotspot for other terminals, select **Hotspot** as the working mode.

Step 3 Click **Apply**.

### 4.6.2.2.2 Configuring Wi-Fi Network

You can connect the Device to network through Wi-Fi.

### NOTE

This function is supported on the Device with the Wi-Fi module only. Follow on-device information.

## Preconditions

Make sure the Device is connected to a Wi-Fi module.

## Steps

**Step 1** Select **Main Menu > NETWORK > WIFI > WLAN**.

The **WLAN** interface is displayed, see Figure 4-60.

Figure 4-60 WLAN

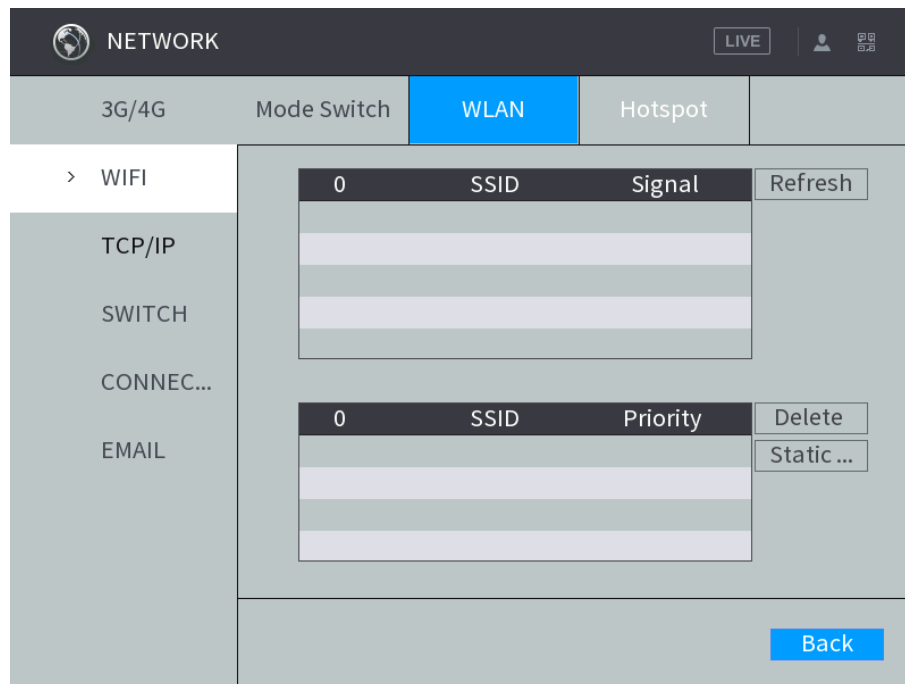

**Step 2** Connect to Wi-Fi.

- Auto search
  1. Auto search Click Refresh.  
Displays all available SSID names and signal strength.
  2. Double-click the Wi-Fi you want to connect, enter the password, and then click Apply.
- Add Wi-Fi manually.
  1. Click **Static Setting**.  
The Static Settings interface is displayed.
  2. Enter SSID and password, select priority level and verification type, set IP address, subnet mask, and gateway.  
If you select the DHCP check box, after successful connection, the system automatically obtains the IP address, subnet mask, and gateway.
  3. Click **Apply**.

## Result verification

After successful connection, you can view the mode status, connection status, IP address, subnet mask, and gateway in the **WIFI Working Information** area in the **Mode Switch** interface.



### 4.6.2.2.3 Configuring Wi-Fi Hotspot

The Device can work as a hotspot to share the network connection to other terminals. The terminals connected to the hotspot can login to the Device through IP address (192.168.2.108). After login, you can preview videos on the Device.

**Step 1** Select Main Menu > NETWORK > WIFI > Hotspot.

The **Hotspot** interface is displayed. See Figure 4-61.

Figure 4-61 Portable Hotspot

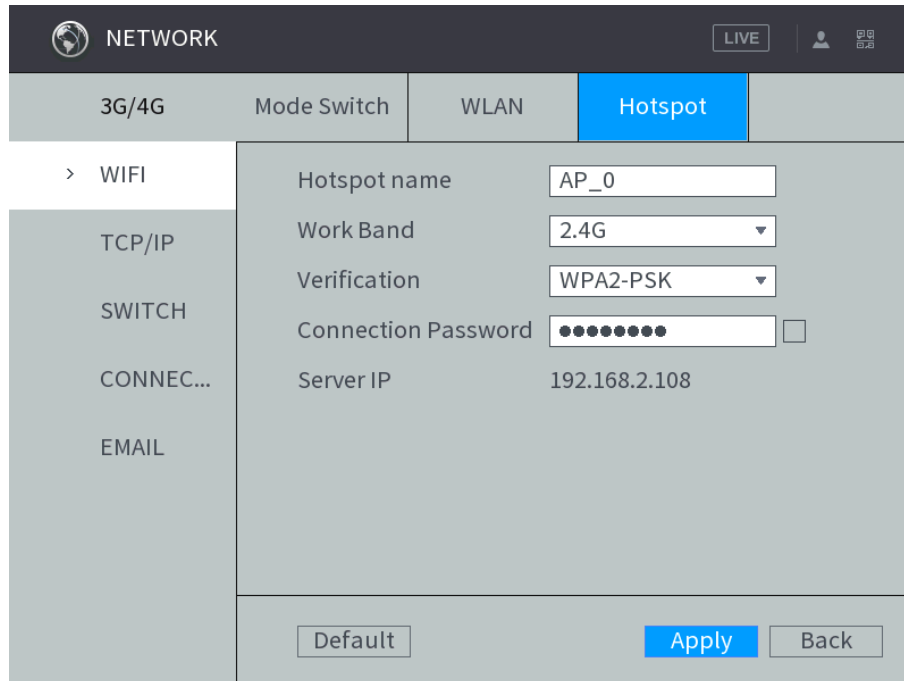

**Step 2** Enter the name of the **Hotspot**, select work band and verification type, and then enter the connection password.

- The work band can be 2.4G/5G.
- Select the Connection Password check box, the clear text password is displayed. The default password is 12345678.

**Step 3** Click **Apply**.

### 4.6.2.3 Configuring 3G/4G Settings

After setting 3G/4G parameters, network status and data usage can be viewed.

#### 4.6.2.3.1 Setting 3G/4G Parameters

##### Preconditions

- Make sure the Device is equipped with 3G/4G module and inserted with SIM card from the Communication Operator.
- The dial number, user name, and password have been obtained from the Communication Operator.

##### Steps

**Step 1** Select **Main Menu > NETWORK > 3G/4G > 3G/4G**.

The **3G/4G** interface is displayed. See Figure 4-62.

Figure 4-62 3G/4G

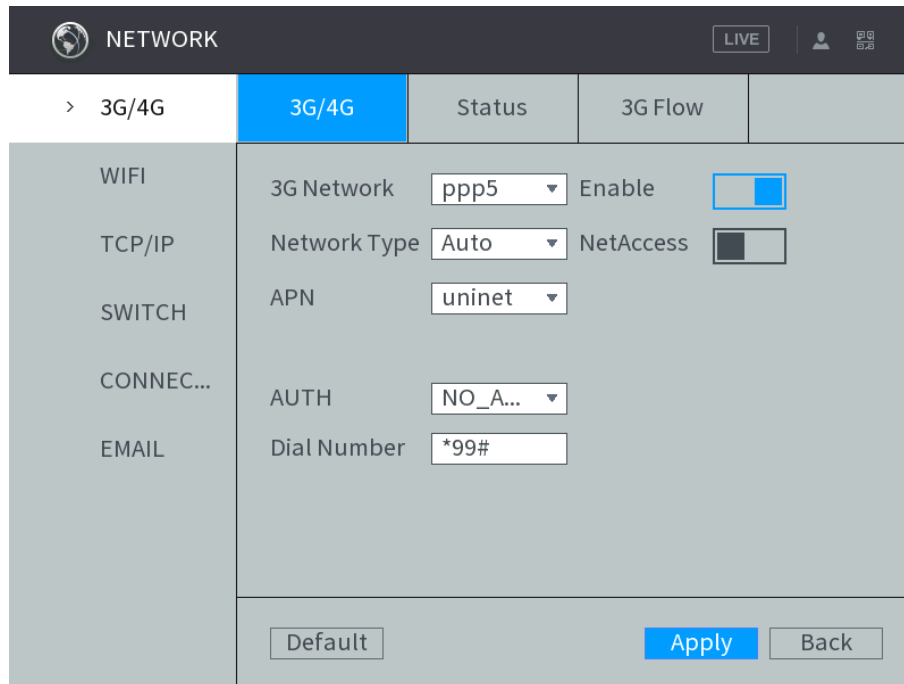

**Step 2** Select **3G Network**, click  to enable the network. This function is enabled by default.

**Step 3** Configure TCP/IP parameters. For details, see Table 4-18.

Table 4-18 3G/4G setting parameters description

Name	Description
NetAccess	When the Device is accessed to private network, click  to enable <b>NetAccess</b> check box, enter APN name and select authentication mode. If <b>PAP</b> or <b>CHAP</b> is selected for <b>AUTH</b> , enter user name and password, then the Device is automatically accessed to private network
Network Type	When enabled, the network type is displayed, which is used to distinguish the 3G/4G modules among Communication Operators, such as TD-LTE
APN	Displays access point of Communication Operator. To manually set up APN, select <b>Customized</b>
AUTH	Includes PAP, CHAP, and NO_AUTH protocols. The system automatically recognizes and displays the enabled protocol
Dial Number	Enter the dial number provided from the Communication Operator
Username	This parameter needs to be set up when the authentication mode is PAP or CHAP The system automatically recognizes the username and password
Password	

**Step 4** Click **Apply**.

After access is succeeded, the obtained IP address is displayed.

#### 4.6.2.3.2 View Mobile Network Status

Check the mobile network status, including module state, SIM state, dialing state, working mode, etc.

In the main menu, select **NETWORK > 3G/4G > Status**. The **Status** interface is displayed. See Figure 4-63.

Figure 4-63 Status

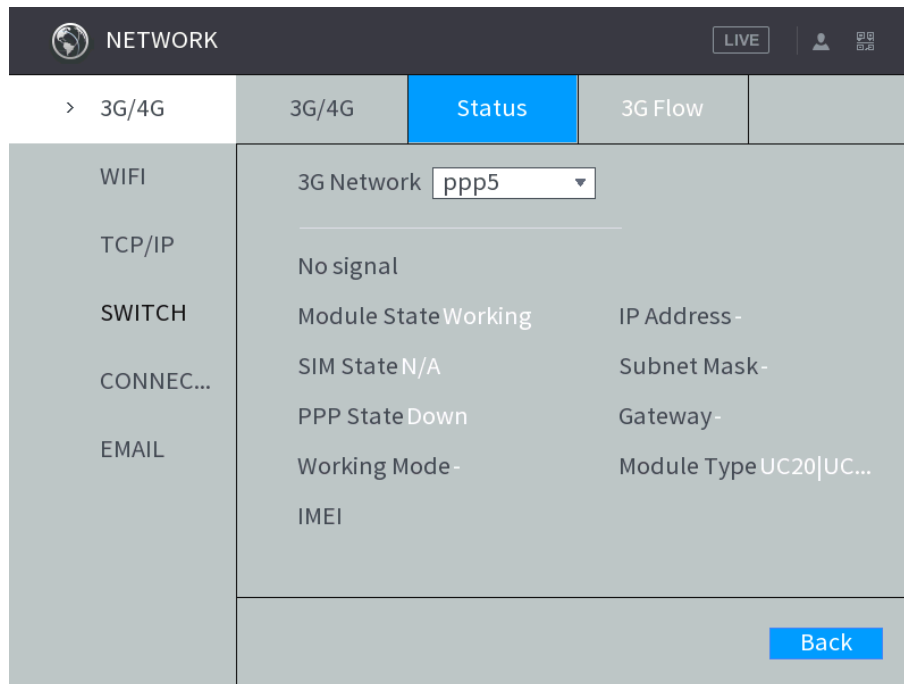

#### 4.6.2.3.3 Review data usage

You can review 3G/4G data usage.

In the main menu, select **NETWORK > 3G/4G > 3G Flow**. The **3G Flow** interface is displayed. See Figure 4-64.

The system displays data usage for the last 7 days and the total data usage of the month up to date. The total data is zeroed out and accumulates again after a calendar month ends and a new one begins.

- Click **Refresh** to obtain the latest updated flow information, which is updated every 5 minutes.
- Click **Zero Out** to clear all information of the current data usage count.

Figure 4-64 Data usage

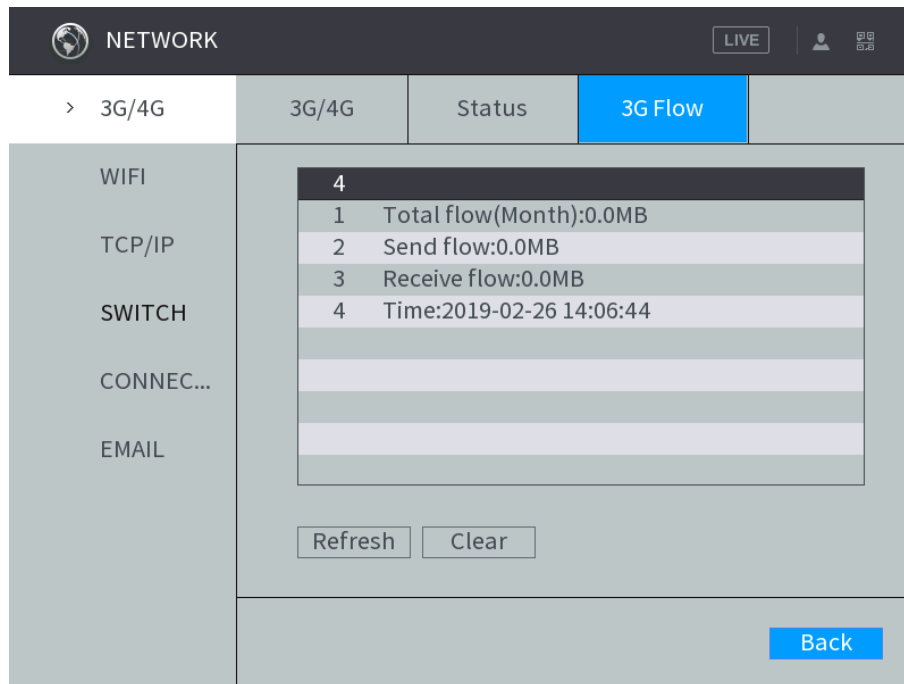

#### 4.6.2.4 Configuring Switch Settings

After setting up the SWITCH, the device automatically allocates IP addresses to the IPC directly connected to the PoE port of the device.

#### CAUTION

- By default, the Switch Settings check box is enabled. The network segment is 10.1.1.1. It is recommended to keep the default setting.
- If the IP camera is from the third party, it must support the Onvif protocol and has enabled DHCP.

Step 1 In the main menu, select **SYSTEM SETUP > NETWORK > SWITCH**.

The Switch interface is displayed. See Figure 4-65.

Figure 4-65 Switch settings

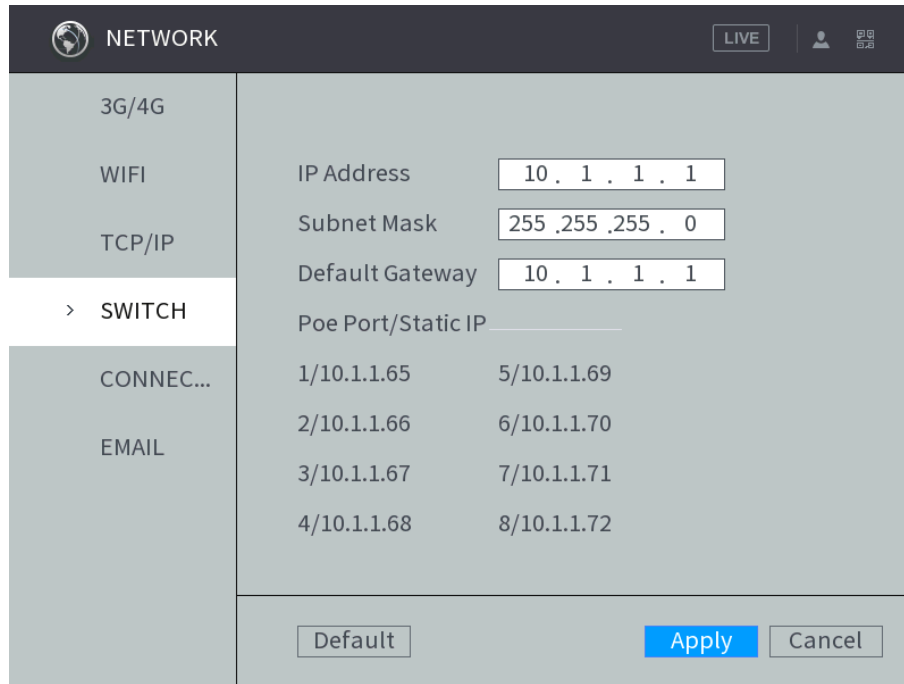

**Step 2** Enter the IP address, subnet mask, and gateway.

**NOTE**

The IP address of Switch cannot be in the same network segment with the IP address of Device. It is recommended to use the default IP address.

**Step 3** Click **Apply**.

## Instructions for PoE Connection

For the PoE connection instructions, see Table 4-19.

Table 4-19 PoE instructions

Operation	Description
The device automatically connects to the IPC managed through the PoE port	<p>After connecting, the Device configures an IP address to the IP camera. This IP address is from the network segment where the Switch is located Try to configure the IP address by arp ping. If the DHCP function is enabled, use DHCP to configure the IP address</p> <ul style="list-style-type: none"> <li>After the IP address is configured, a broadcast will be sent from Switch. If there is any response received, the connection has been established. Then you can login and find the IP camera. You can find the corresponding digital channel has been occupied with a small PoE icon in the top left</li> <li>You can view the PoE channel information in the <b>Added Device</b> area in the <b>REMOTE</b> interface. You can Click <b>Search Device</b> to display or update the status</li> </ul>

**NOTE**

If all channels are occupied, when IPC connects to the device through the interface, it will automatically preempt the connected channels and go online, and the remote channels will be overwritten.

## 4.6.2.5 Configuring Network Testing Settings

You can test the network status and load.

### 4.6.2.5.1 Testing Network Status

You can test the network status and view the average delay and packet loss rate.

**Step 1** In the main menu, select **Info > Network > Net Test**

The **NET TEST** interface is displayed. See Figure 4-66.

Figure 4-66 Net test

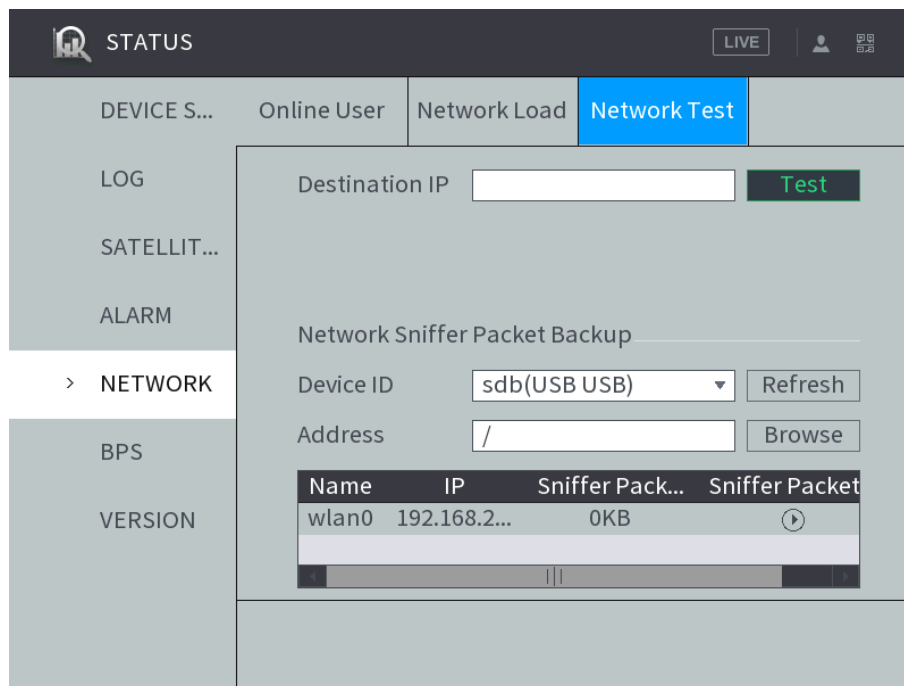

**Step 2** In the **Destination IP** box, enter the IP address, and then click **Test**.

After testing is completed, the test result is displayed. You can view the evaluation for average delay, packet loss rate, and network status.

### 4.6.2.5.2 Testing Network Load

You can view all the network information of the device, such as MAC address, connection status, IP address, data receiving speed and sending speed.

**Step 1** In the main menu, select **Info > Network > Net Load**

The **NET LOAD** interface is displayed. See Figure 4-67.

Figure 4-67 Net load

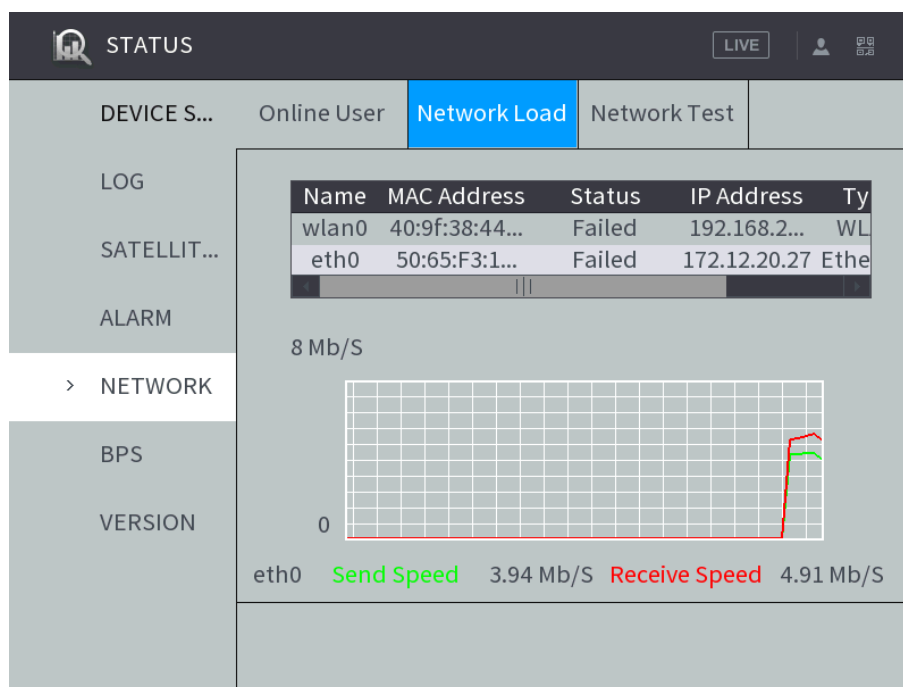

**Step 2** Click the network that you want to view. The data receiving speed and sending speed information are displayed.

**NOTE**

- By default, the network load of eth0 is displayed.
- The green line represents data sending speed, and the red line represents data receiving speed.

## 4.6.3 Configuring platform

### 4.6.3.1 Setting up auto registration

After successfully auto registered, when the device is connected into the Internet, it will report the current location to the specified server to make it easier for the Client software to access the Device, and to preview and monitor it.

**Step 1** Select **PLATFORM > REGISTER**

The Auto Registration interface is displayed. See Figure 4-68.

Figure 4-68 Auto Registration

**Step 2** Click  to enable automatic registration.

**Step 3** Configure TCP/IP parameters. For details, see Table 4-20.

Table 4-20 Auto Registration descriptions

Name	Description
No.	Number automatically registered
Address	In the Server IP box, enter the IP address or domain name of the server to register
Port	The port for auto-registration
Sub-device ID	Unique ID for identifying the device. When different devices register to the same server, the sub-device IDs should be different
Username	User name and password used for authentication when registering to the platform.
Password	

**Step 4** Click **Apply**.

### 4.6.3.2 Configuring P2P Settings

P2P is a private network penetration technology. With this technology, you do not need to apply for dynamic domain name, set port mapping, or deploy transit server. You can add devices for management by either of the following two ways.

- Download an app to your mobile phone by scanning the QR code on the interface by using mobile phone client, and sign up an account. See “Client Operation Examples.”
- Login [www.gotop2p.com](http://www.gotop2p.com) platform to register, and then add devices by device serial number. For details, see P2P Operation Manual.



Before using P2P, make sure the device is connected to the Internet.



## Preconditions

- The device is connected to the Internet.
- DMSS Client is downloaded and installed on you mobile phone.

## Steps

### Step 1 Select **PLATFORM** > **P2P**

The P2P interface is displayed, see Figure 4-69.

Figure 4-69 P2P

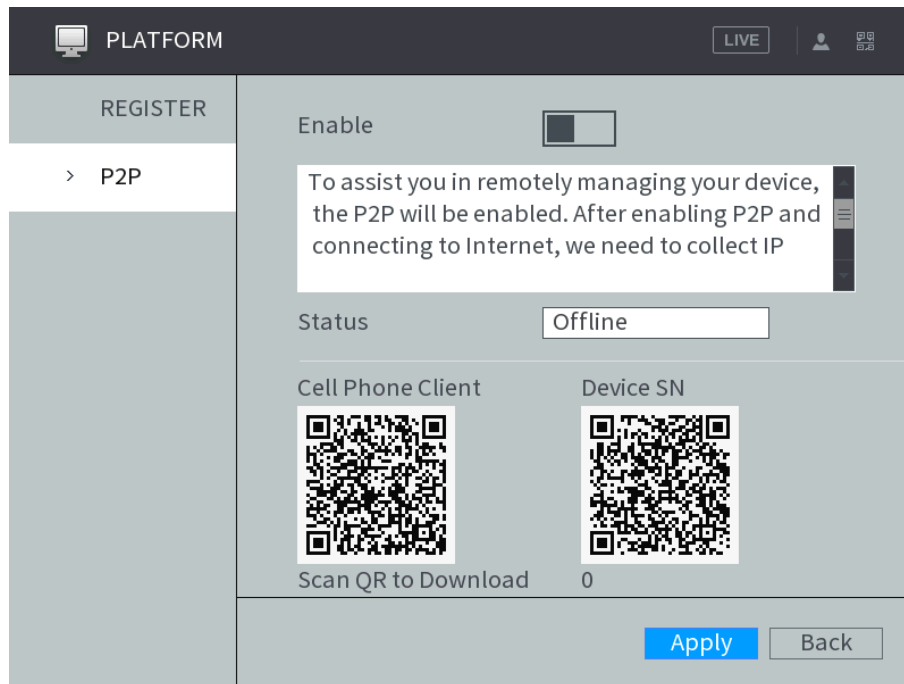

Step 2 Click  to enable P2P function.

Step 3 Use DMSS Client to scan the QR code under Device SN to add the device to DMSS Client.



Scan the QR code on the actual interface of Device.

Step 4 Click **OK**.

After configuration is complete, the Status box shows **Online**, meaning the P2P registration is successful.



## Adding Device into Mobile Phone Client

To use this function, take adding device into mobile phone client as an example.

Step 1 On your mobile phone, download the application.

Step 2 After the installation, run the client, select **Remote Monitoring** and go to the main menu.

Step 3 Add the device to the mobile client.

- 1) Click  and then select Device Manager.  
The **Device Manager** interface is displayed.
- 2) Click , initialize the device as needed and follow on-screen instructions to connect the device. To do so, you can scan the device label or the serial number QR code of the device on the device page.  
After scanning, the device is added. The serial number of the device is displayed in **Serial Number** section.

Step 4 To review the monitoring image of the device, click **Start Preview**.

## 4.6.4 Setting Device Storage

### 4.6.4.1 Setting basic parameters

Step 1 In the main menu, select **Storage Management > Basic Configuration**.  
The **Basic Configuration** interface is displayed. See Figure 4-70.

Figure 4-70 Basic configuration

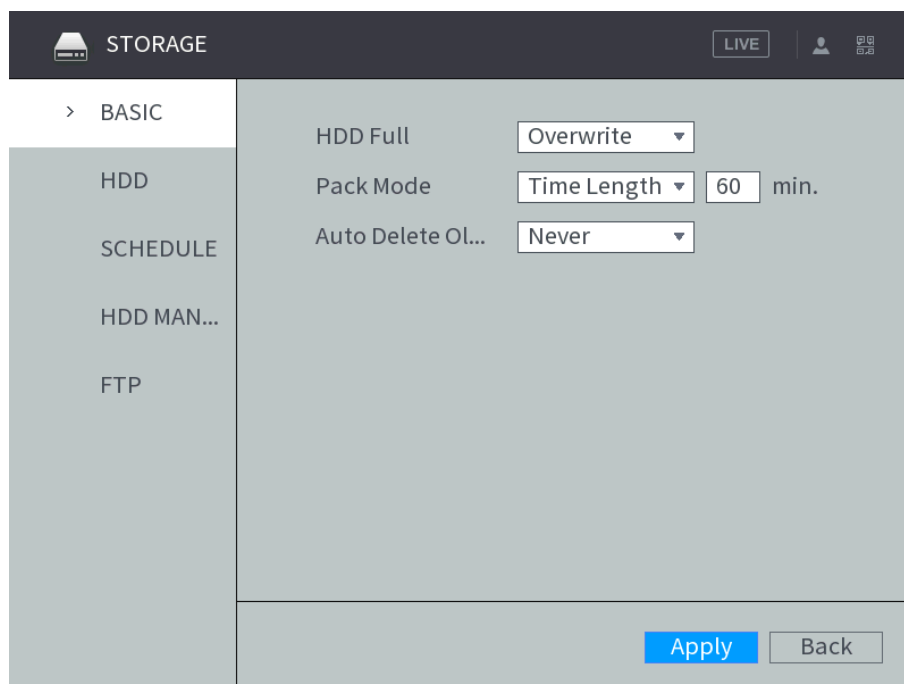

Step 2 Configure basic information.

- Select either to stop recording or overlap earlier recordings when HDD is full.
- Set up the length for packaging recordings.
- After configuring auto deleting old files, when the Device is working, it deletes the old files that occurred before the set schedule.

Step 3 Click **Apply**.

### 4.6.4.2 Managing Storage Device

Select **Main Menu > STORAGE > HDD Management**. The **HDD Management** interface is displayed. See Figure 4-71.

You can set up the HDD as the read/write disk and redundancy HDD in the **Type** column.

- Read/Write: Read HDD data and save data to HDD.
- Redundancy HDD: If more than two HDDs are connected to the device or SD card, one HDD can be set to the redundancy HDD for recording backup.

Select the HDD and click **Formatting** to clear all data from the HDD. Proceed with caution.

Figure 4-71 Disk management

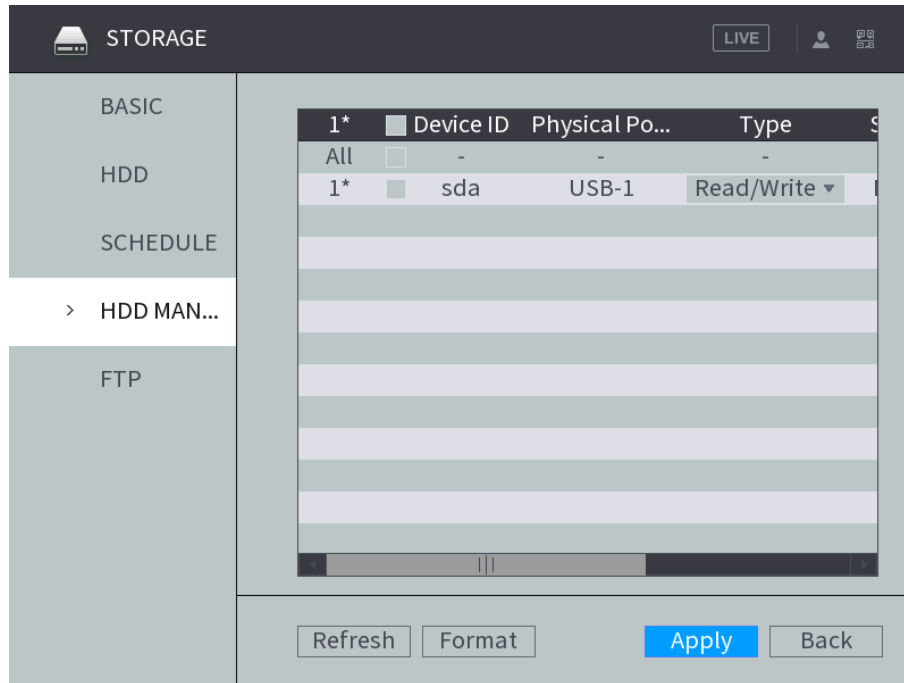

#### 4.6.4.3 Setting FTP storage

Back up recorded videos and images to the preset FTP (File Transfer Protocol) server for storage.

#### Preconditions

Make sure you have purchased or download a FTP server and installed it on your PC.

#### NOTE

For the created FTP user, you need to set the write permission; otherwise the upload of recorded videos and snapshots will be failed.

#### Steps

Step 1 In the main menu, select **STORAGE > FTP**.

The FTP interface is displayed, see Figure 4-72.

Figure 4-72 FTP

The screenshot shows the 'STORAGE' configuration page with the 'FTP' tab selected. The 'Enable' checkbox is checked. The 'SFTP (Recommended)' radio button is selected. The 'Server IP' is set to '0.0.0.0' and the 'Port' is '22'. There are input fields for 'Username' and 'Password'. The 'Anonymous' checkbox is unchecked. The 'Remot...' field is empty and the 'Channel' is set to '1'. 'File Length(M)' is '0' and 'Image Upload ...' is '2'. The 'week' is set to 'Tue'. There are two scheduling periods, both set to '00:00 - 24:00'. At the bottom, there are buttons for 'Default', 'Test', 'Apply', and 'Back'.

**Step 2** Select **Enable** to enable FTP upload.

**Step 3** The system selects **SFTP** by default. It is recommended to keep this default setting. When selecting **FTP**, the system gives a risk prompt. Select **OK** or **Cancel** based on your needs.

**Step 4** Configure TCP/IP parameters. For details, see Table 4-21.

Table 4-21 FTP parameter description

Name	Description
Server IP	The IP address of the PC that is installed with the FTP/SFTP server
Port	The default value is 21
Username	The username and password used to access the server
Password	
Anonymous	Select <b>Anonymous</b> if you want to login to the server anonymously
Remote Directory	<p>Create folder on FTP server</p> <ul style="list-style-type: none"> <li>If you do not enter the name of remote directory, the system automatically creates the folders according to the IP, time, and channel</li> <li>If you enter the name of remote directory, the system creates the folder with the entered name under the FTP/SFTP root directory first, and then automatically creates the folders according to the IP, time, and channel</li> </ul>
File Length	<p>Enter the length of the uploaded recorded video</p> <ul style="list-style-type: none"> <li>If the entered length is less than the recorded video length, only a section of the recorded video can be uploaded</li> <li>If the entered length is more than the recorded video length, the whole recorded video can be uploaded</li> <li>If the entered length is 0, the whole recorded video will be uploaded</li> </ul>

Name	Description
Image Upload Interval	<ul style="list-style-type: none"> <li>● When the <b>Snap Mode</b> is <b>Regular</b>, the image upload method should be determined according to the upload interval and snapshot interval. <ul style="list-style-type: none"> <li>◇ If this interval is longer than snapshot interval, the system uploads the most recent snapshot. For example, if the upload interval is 5 seconds, and snapshot interval is 2 seconds per snapshot, then an upload command is issued every 5 seconds to upload the following picture captured.</li> <li>◇ If this interval is shorter than snapshot interval, the system uploads the snapshot per the snapshot interval. For example, if the interval is 5 seconds, and snapshot interval is 10 seconds per snapshot, the system uploads the snapshot every 10 seconds</li> </ul> </li> <li>● When the <b>Snap Mode</b> is <b>Event</b>, the system uploads captured pictures according to snapshot interval.</li> </ul> <p> <b>NOTE</b>  You can configure the <b>Interval</b> and <b>Snap Mode</b>. For details, see “4.6.1.1.2Configuring Snapshot Streaming”.</p>
Channel	Select the channel that you want to apply the FTP settings
Weekday	Select the week day and set the time period that you want to upload the recorded files. You can set two periods for each week
Time Period	Select the record type (Alarm, MD, and General) that you want to upload. After checking the corresponding recording type next to the corresponding period, the selected recording type will be uploaded during the configured period

**Step 5** Click **Test** to test if the FTP/SFTP server is successfully configured.

- If successful, the system will pop up a message to indicate successful connection.
- If failed, the system will pop up a message to indicate failed connection. Check the network connection or configurations.

**Step 6** Click **Apply**.

#### 4.6.4.4 Viewing HDD Information

Select **Main Menu > STORAGE > HDD**. The **HDD** interface is displayed. The following operations can be performed in this interface.

- Click the **HDD** to view the list of video recordings in it, as shown in Figure 4-73.
- Double-click the **HDD** to view the S.M.A.R.T information of the **HDD**, as shown in Figure 4-74.

Figure 4-73 List of video recordings

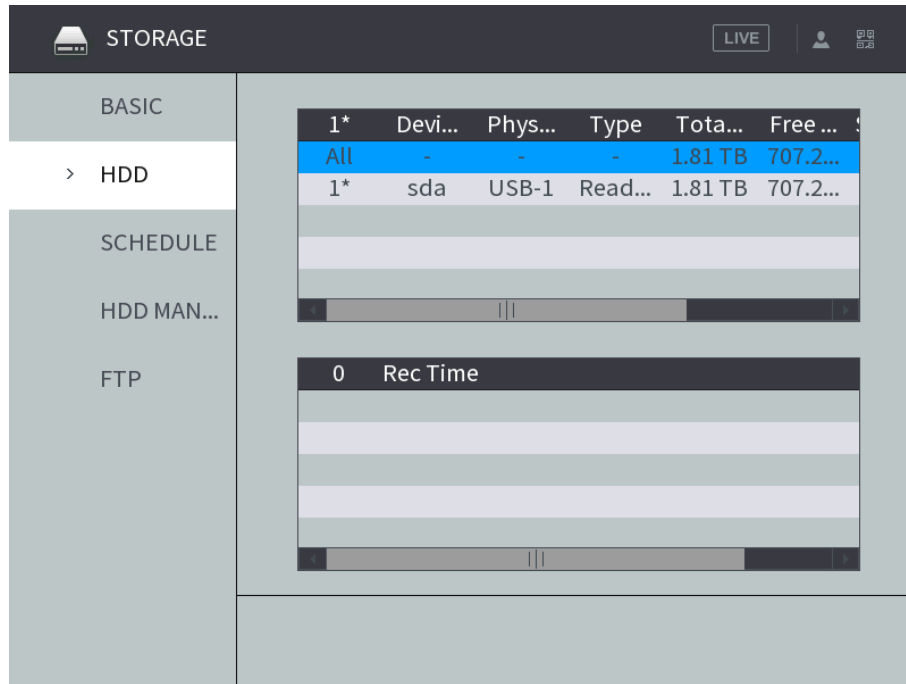
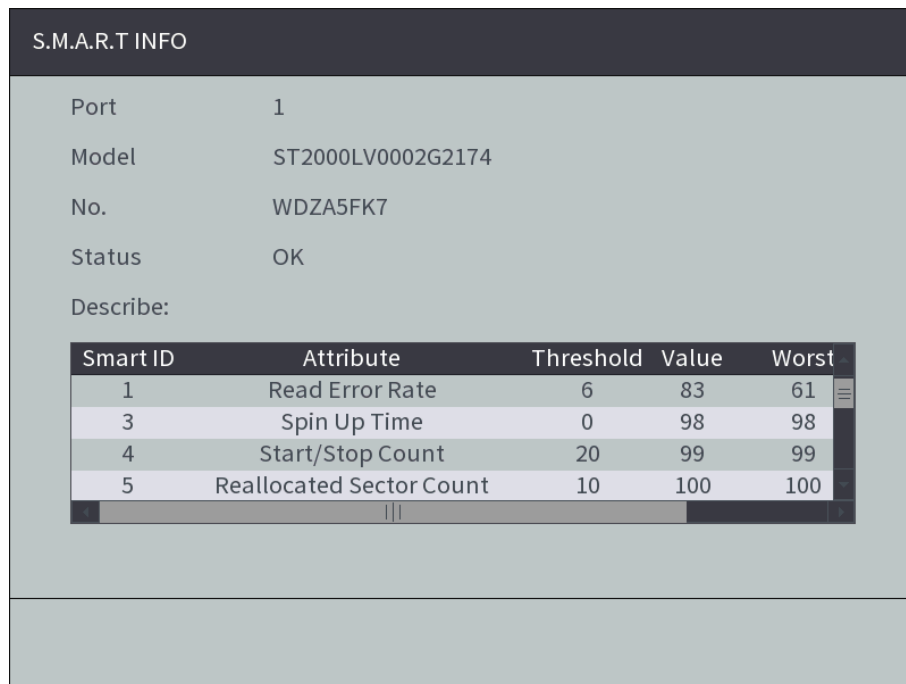

Figure 4-74 S.M.A.R.T information



### 4.6.5 Setting user info

User management of the device adopts two levels: user and user group. You can manage the basic information of users and user groups. To manage account easily, it is recommended to give lower authority to the common user account than the advanced user account Authority



- In order to ensure the safety of the device, operations in the **ACCOUNT** interface (such as adding users, deleting users, etc.) can only be performed after the user's login password is correctly entered.

- When operating in the **ACCOUNT** interface, if the **ACCOUNT** interface is not closed after the login password is correctly entered once, other operations can be directly performed. If you re-enter the **ACCOUNT** interface after closing it, you need to enter the login password again. Follow the interface prompts.

### 4.6.5.1 Setting up user group

In the actual use scenario, users accessing the device may have different permissions. You can group users of different levels to facilitate maintenance and management of user information.

- Up to 64 user groups can be created in the system and the maximum length of user group names is 64 characters.
- Admin and Onvif user groups are default in the system, which cannot be deleted.
- New user group can only be created under the root node.

### Steps

**Step 1** Select **Main Menu > SYSTEM > ACCOUNT > Group Setup**.

The Group Setup interface is displayed, see Figure 4-75.

Figure 4-75 Group name

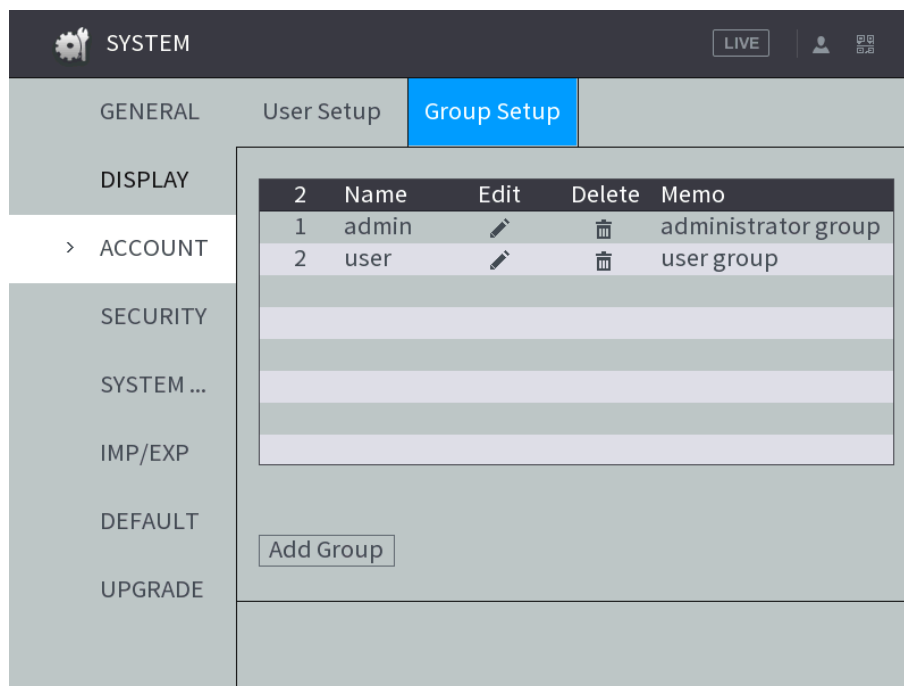

**Step 2** Click Add Group.

The **Add Group** interface is displayed. See Figure 4-76.

Figure 4-76 Add group

**Step 3** Configure TCP/IP parameters. For details, see Table 4-22.

Table 4-22 Description of group parameters

Name	Description
Group name	Setting up group name The group name can be set to a maximum of 64 characters and may contain letters, numbers and special symbols (including “_”, “@”, “.”).
Remarks	Setting up note info.

**Step 4** Click the **System**, **Playback** or **Monitor** tabs respectively to set user group permissions.



Select **All** to select all permissions under this category.

**Step 5** Click **OK**.



## Related Operations

After adding user groups, user group information can be edited and user groups can be deleted. Refer to Table 4-23 for details.

Table 4-23 Related Operations

Function	Operation
Edit user group info	Click  to edit group info.



Function	Operation
Delete group	<p>Click  to delete the group.</p> <p></p> <ul style="list-style-type: none"> <li>You can delete a group only if there is no user under the group.</li> <li>The groups of Admin and User cannot be deleted.</li> </ul>

#### 4.6.5.2 Setting up system user

The system user is used to access and manage the device, and the system default administrator is admin. When adding different users, ensure that users can only access resources within their own permissions.

#### Steps

**Step 1** Select **Main Menu > SYSTEM > ACCOUNT > User Setup**.

The **User Setup** interface is displayed, see Figure 4-77.

Figure 4-77 User

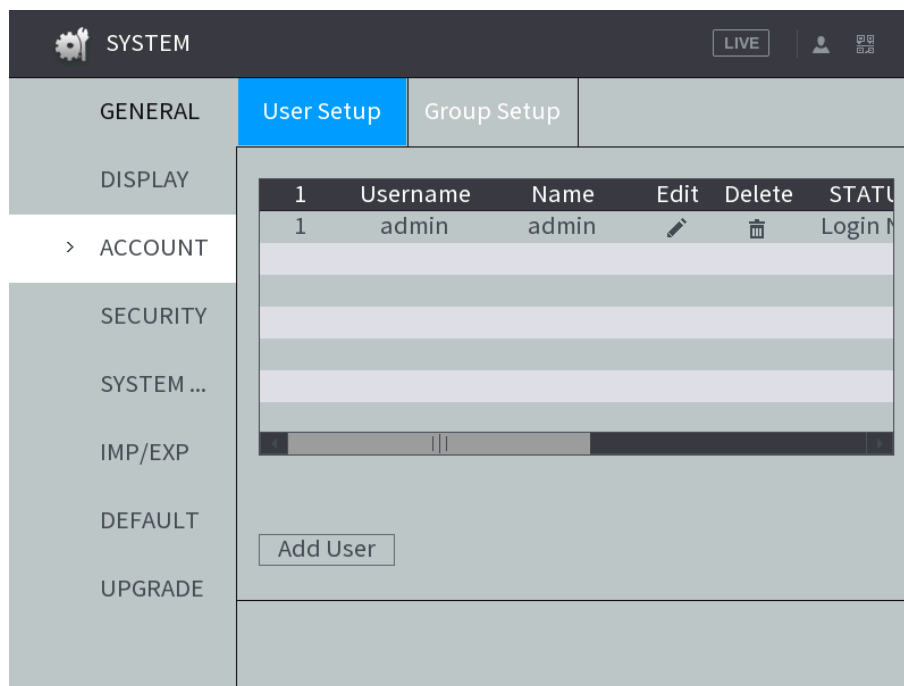

**Step 2** Click **Add User**.

The system displays the **Add User** interface. See Figure 4-78.

Figure 4-78 Add User.

**Step 3** Configure TCP/IP parameters. For details, see Table 4-24.

Table 4-24 Description of user parameters

Name	Description
Username	Setting up user name. The user name can be set to a maximum of 64 characters and may contain letters, numbers and special symbols (including “_”, “@”, “.”).
Password	Setting up user password and confirming it.
Confirm Pwd	The new password can be set from 8 characters through 32 characters and may contain two or more types from number, letter and special characters (excluding ' " ; : &).Enter a strong password according to the security level indication.
Remarks	Enter a description of the user
User MAC	Binding the MAC address of the user PC accessing the device.
Group name	Selecting the group to which users belong.

**Step 4** Click the **System**, **Playback** or **Real-time Monitoring** tabs respectively to set user permissions.

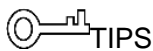

Select **All** to select all permissions under this category.





**Step 5** Click **OK**.

## Related Operations

After adding users, user information can be edited and users can be deleted. Refer to Table 4-25 for details.

Table 4-25 Related Operations

Function	Operation
----------	-----------

Function	Operation
Editing user info	<p>Click  to modify information such as group, user password and reserved mobile phone.</p> <p> <b>NOTE</b></p> <p style="text-align: right;">Modification of reserved mobile phones is only available for admin account.</p>
Delete User	<p>Click  to delete the user.</p> <p> <b>NOTE</b></p> <ul style="list-style-type: none"> <li>• The admin account cannot be deleted.</li> <li>• To delete online users, you need to log into the local interface to block online users first.</li> </ul>

### 4.6.5.3 Online User

Select **Main Menu > STATUS > NETWORK > Online User**, the **Online User** interface is displayed. See Figure 4-79.

Set the blocking time and click  to block online users.

Figure 4-79 Online User

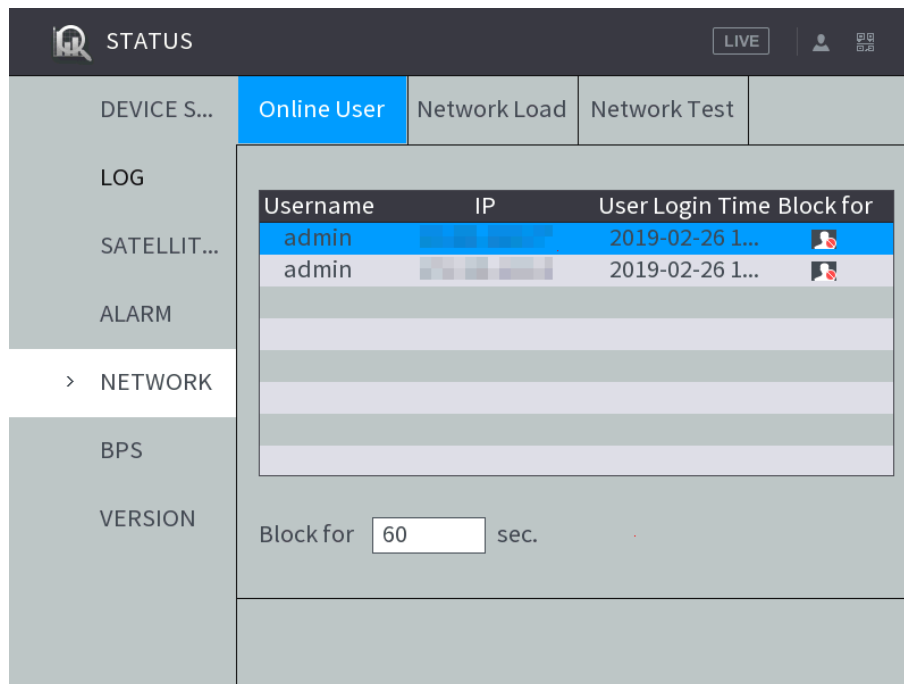

### 4.6.6 Set up system services

The device supports setting up the startup and shutdown of various internal service functions of the system.

Step 1 Select **Main Menu > SYSTEM > SECURITY > System Service**.

The **System Service** interface is displayed. See Figure 4-80.

Figure 4-80 System service

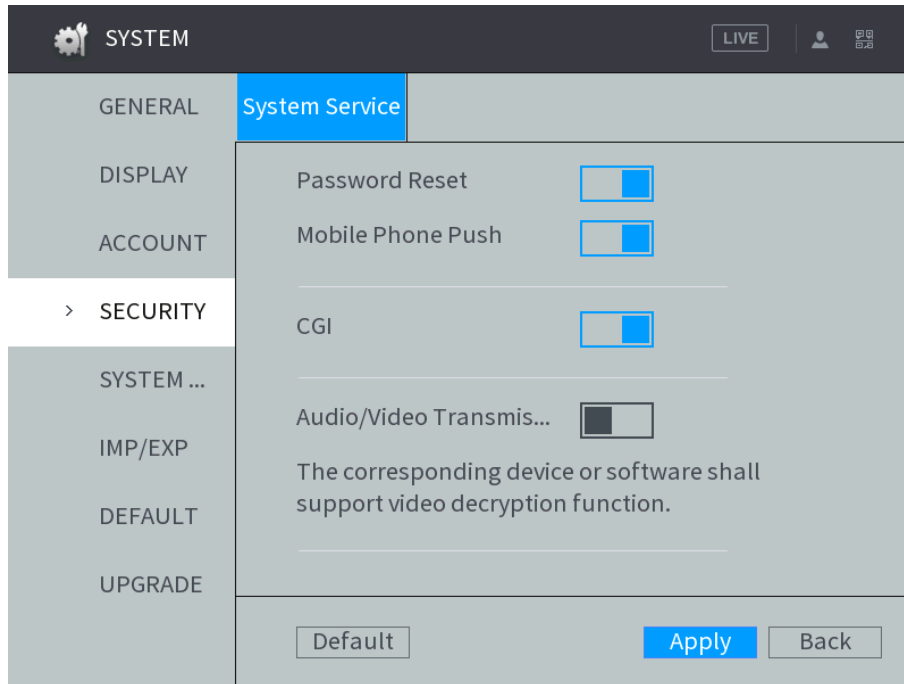

**Step 2** Configure TCP/IP parameters. For details, see Table 4-26.

Table 4-26 Description of system service parameters

Name	Description
Reset Password	<p>After this function is enabled, you can reset a new login password of the admin account if the old one is lost. The system enables this function by default.</p> <p> <b>NOTE</b></p> <p>When the <b>Password Reset</b> function is disabled, the password can only be reset through the password protection question in the local interface. Make sure that the password protection question is set.</p>
Mobile phone push	<p>When this function is enabled, the device can push the triggered alarm snapshot to the mobile phone. The system enables this function by default.</p>
CGI	<p>When enabled, the device can interface with other devices through CGI protocol. The system enables this function by default.</p>
Audio and Video Transmission Encryption	<p>When enabled, the transmitted audio and video can be encrypted.</p> <p> <b>NOTE</b></p> <p>Video decryption should be provided by supporting device or software.</p>

**Step 3** Click **Apply**.

## 4.6.7 Configuring display output

Configure display output parameters, including resolution, tour settings, TV adjustment, and video mirror.

### 4.6.7.1 Configuring resolution

Step 1 In the main menu, select **System Management > Display Output > Display Output**.

The **Display Output** interface is displayed. See Figure 4-81.

Figure 4-81 Display output

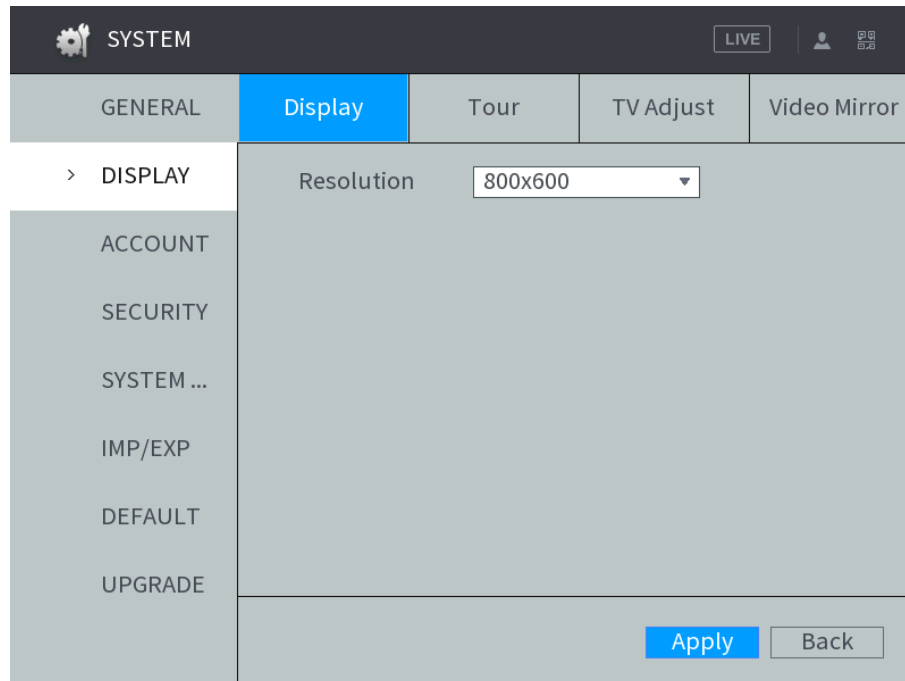

Step 2 Select resolution.

Step 3 Click **Apply**.

### 4.6.7.2 Configuring tour parameters

Step 1 In the main menu, select **System Management > Display Output > Tour**.

The **Tour** interface is displayed, see Figure 4-82.

Figure 4-82 Tour

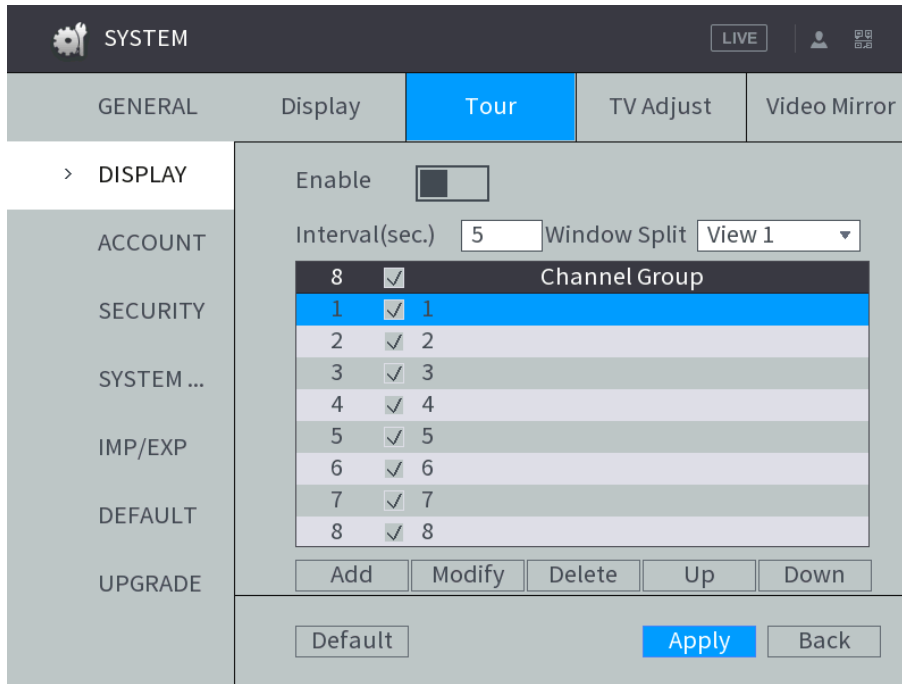

**Step 2** Click  and enable the tour function.

**Step 3** Set up the interval time.

**Step 4** Select image split and then the touring channel accordingly.

- Click **Add** to customize the touring sequence.
- Select the channel combination; click **Modify** to modify the touring channels and touring sequence.
- Select the check box of any channel group, and then click **Delete** to delete the channel group.
- Select the check box of any channel group, and then click **Up** or **Down** to adjust the position of the channel group.

**Step 5** Click **Apply**.

### 4.6.7.3 Adjust TV parameters

**Step 1** In the main menu, select **System Management > Display Output > TV Adjustment**.

The **TV Adjustment** interface is displayed. See Figure 4-83.

Figure 4-83 TV adjustment

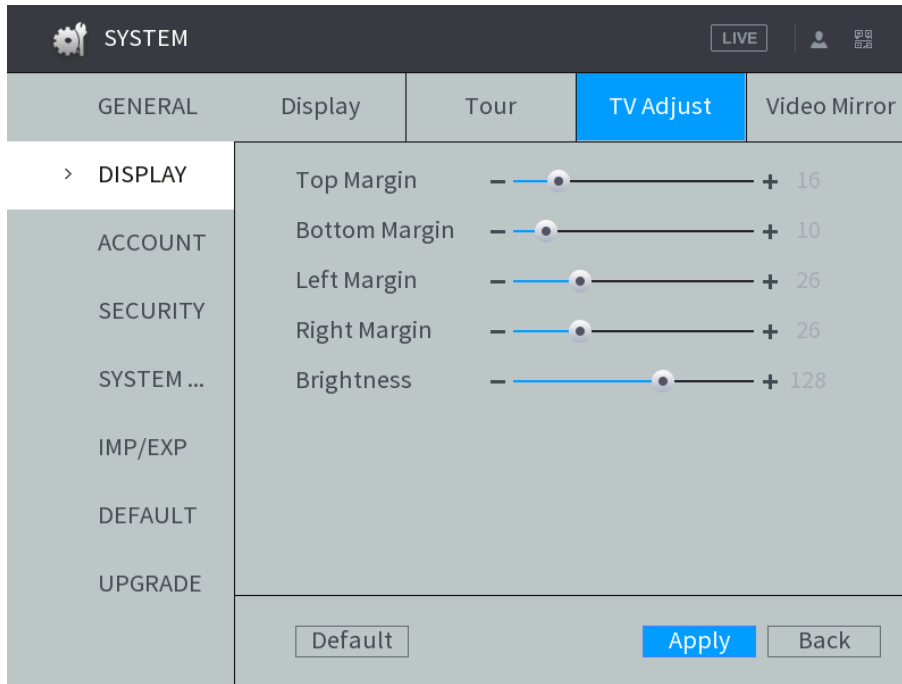

**Step 2** Drag the slider to adjust the TV brightness and the upper, lower, left and right margin.

**Step 3** Click **Apply**.

#### 4.6.7.4 Configuring Video Mirror settings

**Step 1** In the main menu, select **System Management > Display Output > Video Mirror**. The **Video Mirror** interface is displayed. See Figure 4-84.

Figure 4-84 Video Mirror

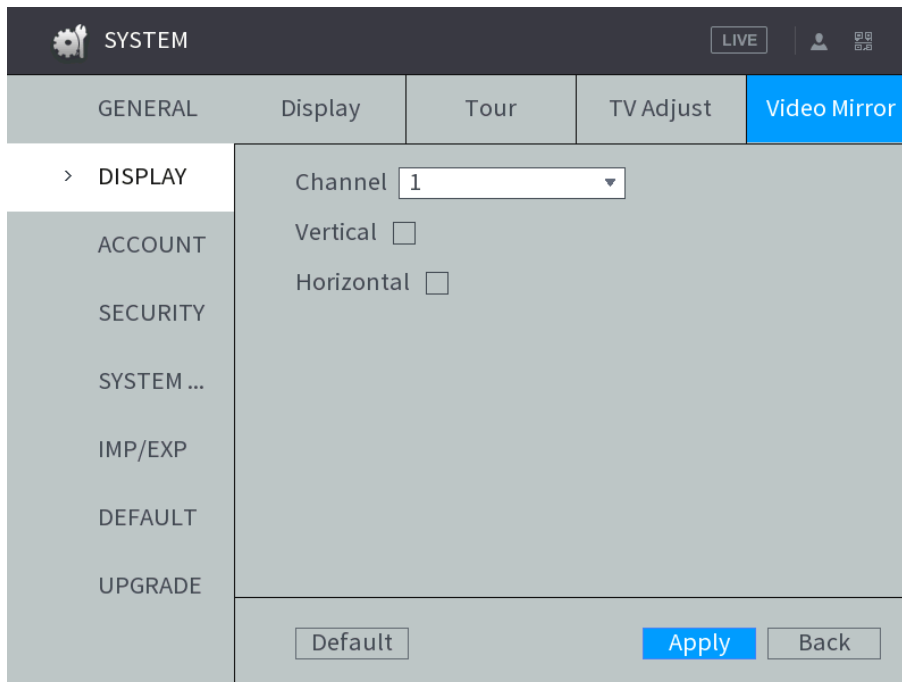

**Step 2** Select the channel and set up the mirror mode. You can select left/right mirror and up/down mirror.

**Step 3** Click **Apply**.

## 4.6.8 Configuring RS-232 port function

After the RS-232 function is set, the device can be connected to other devices through the serial port for tuning and operation.

**Step 1** Select **Main Menu > OTHERS > RS232**.

The RS232 settings interface is displayed, see Figure 4-85.

Figure 4-85 RS232 settings

The screenshot shows a web-based configuration interface. At the top, there's a header with a gear icon, the word 'OTHERS', a 'LIVE' button, and user icons. Below the header is a navigation bar with three tabs: 'RS232', 'MainCom', and 'Extended se...'. The 'MainCom' tab is highlighted in blue. Underneath, there's a section for 'VEHICLE' with five settings, each in a dropdown menu: 'Function' (set to 'Console'), 'Baud Rate' (set to '115200'), 'Data Bits' (set to '8'), 'Stop Bits' (set to '1'), and 'Parity' (set to 'None'). At the bottom of the settings area, there are three buttons: 'Default', 'Apply' (highlighted in blue), and 'Back'.

**Step 2** Select the **MainCom** or **Extended Serial Port** tab according to the serial port function.

- Select the **MainCom** tab when using a normal serial port or connecting a car lamp box.
- When RS485 is used, select the **Extended Serial Port** tab.

**Step 3** Configure TCP/IP parameters. For details, see Table 4-27.

Table 4-27 Serial port parameter description

Name	Description
Function	Select the corresponding protocol <ul style="list-style-type: none"> <li>• Console: Upgrades programs and debug by suing the serial interface and mini terminal software</li> <li>• Vehicle lamp box: An external vehicle lamp box can be connected.</li> <li>• RS485: External RS485 peripherals can be connected.</li> </ul>
Baud rate	The times of signal changes on the transmission line in time unit <ul style="list-style-type: none"> <li>• For a console and RS485, the default baud rate is 115200.</li> <li>• The default baud rate of the vehicle lamp box is 9600.</li> </ul>
Data bit	Select a data bit. The options include <b>5,6, 7, and 8</b>
Stop bit	Select a stop bit. The options includes <b>1, 1.5, and 2</b>
Parity	Select a parity mode from None, Odd, Even, Mark, and Null

**Step 4** Click **Apply**.



## 4.6.9 Configuring Vehicle Settings

### 4.6.9.1 Configuring Speed

**Step 1** Select **Main Menu > OTHERS > VEHICLE > SPEED**.

The **SPEED** interface is displayed. See Figure 4-86.

Figure 4-86 Speed

The screenshot shows a configuration screen for 'SPEED' under the 'VEHICLE' category. The 'OTHERS' menu is at the top. The 'SPEED' tab is selected. The interface includes the following elements:

- Speed Ratio:** Input field with value 6400.
- Speed(KM/H):** Displayed value 0.0.
- Start Mileage:** Input field with value 0.0, followed by 'KM...' and 'Mileage C...' with a dropdown set to 'Always'.
- Mileage(KM):** Input field with value 23.4, and a 'Clear' button.
- Speed s...:** Dropdown menu set to 'Pulse&Position I...'.
- Pulse:** Displayed value 0.0 Hz.
- Buttons:** 'Default', 'Apply', and 'Back' at the bottom.

**Step 2** Sets up DBHA parameters. See Table 4-28 for details.

Table 4-28 Speed parameters description

Name	Description
Speed Ratio	The parameter for converting speed
Mileage Cumulation	Select the vehicle mileage cumulation mode
Mileage	Displays the total mileage
Start Mileage	Enter the initial mileage of the vehicle
Speed source	Select where the speed is obtained, including <b>Pulse</b> , <b>Positioning Info</b> , and <b>Pulse&amp;Positioning Info</b> <ul style="list-style-type: none"> <li>• Pulse 1: Get the speed information from vehicle pulse system</li> <li>• Positioning Info: Get the speed information from positioning system</li> <li>• Pulse&amp;Positioning Info: Get the speed data from both the pulse system and positioning system. Data from the impulse system is used first</li> </ul>

**Step 3** Click **Apply**.

### 4.6.9.2 Configuring Gyro

Used to detect the rollover, collision, sharp turn, rapid acceleration or deceleration of the vehicle.

The default values displayed on the interface can deviate from the actual installation position. Without correction, the vehicle running as intended can also trigger an alarm.

**Step 1** Select **Main Menu > OTHERS > VEHICLE > Gyro**.

The **Gyro** interface is displayed, see Figure 4-87. On this interface, you can view the acceleration, angular velocity and temperature of the vehicle where the device is located.

Click **Reset** to correct the acceleration and angular velocity of the vehicle.

Figure 4-87 Gyro

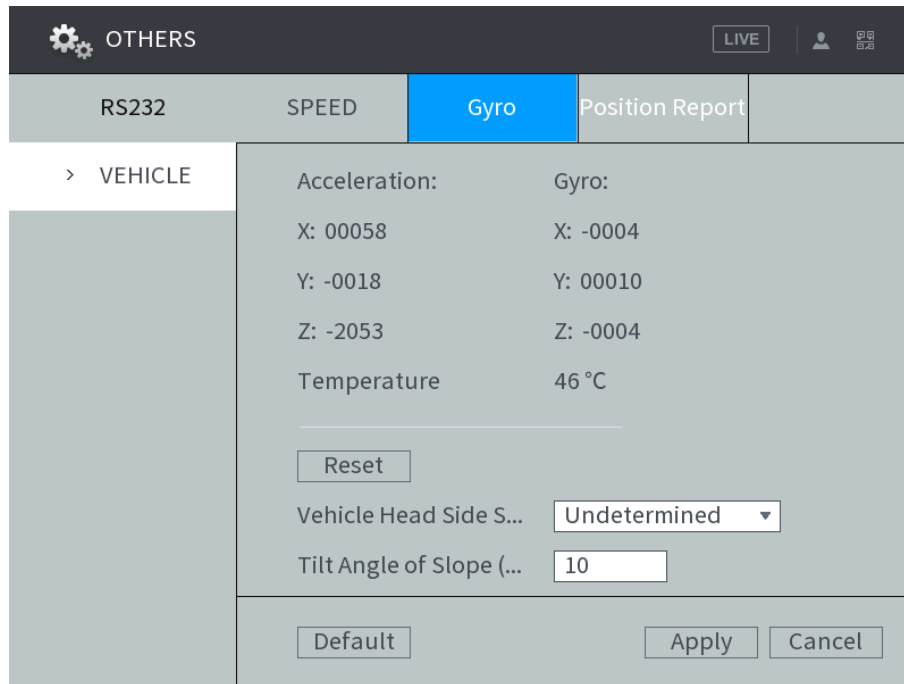

**Step 2** Sets up DBHA parameters. See Table 4-29 for details.

Table 4-29 Description of Gyro parameters

Name	Description
Type of vehicle head side axle	Select the type of vehicle head side axle coordinates and the tilt angle of the slope Vehicle head side axes include X/Y/Z axes
Inclination angle of slope (Unit: °)	Only when the <b>Vehicle Head Side Shaft</b> is not <b>Undetermined</b> can the system detect the rapid acceleration and deceleration events of the vehicle.

**Step 3** Click **Apply**.

### 4.6.9.3 Configuring Position Report

You can configure the position report strategy to be device auto report or report per platform schedule.

**Step 1** Select **Main Menu > OTHERS > VEHICLE > Position Report**.

The **Position Report** interface is displayed.

**Step 2** Configure the report strategy.

- Auto report.
  1. In the **Report Strategy** list, select **Device Auto**.  
The **Device Auto** setting interface is displayed. See Figure 4-88.

Figure 4-88 Position report (device auto)

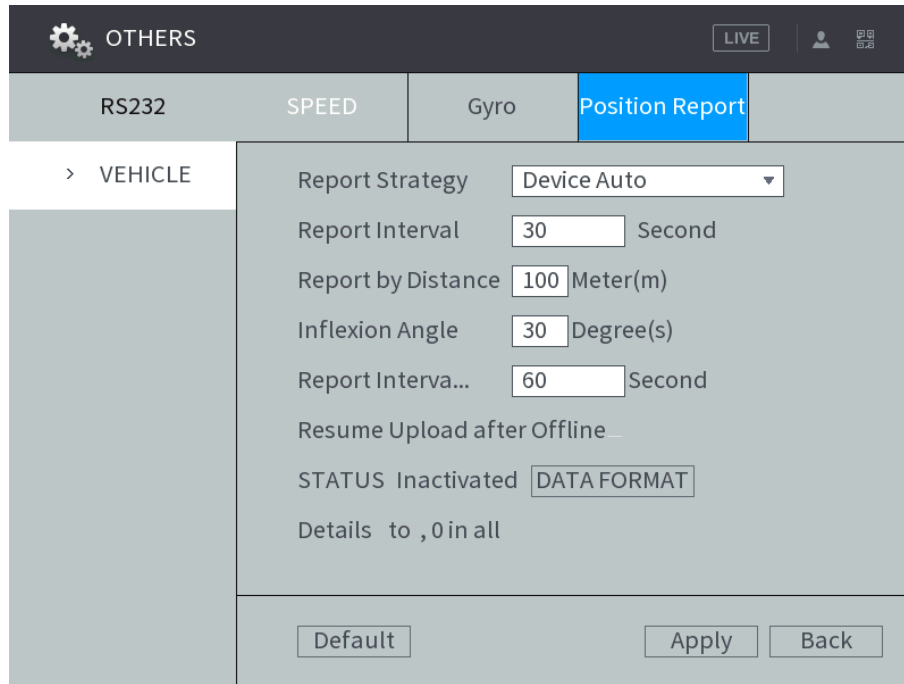

2. Configure TCP/IP parameters. For details, see Table 4-30.

Table 4-30 Device auto report parameters description

Name	Description
Report Interval	When the vehicle ACC status is on, the system report the position to platform according to the configured report interval, report distance, and inflexion angle
Report by Distance	
Inflexion Angle	The system reports vehicle position to platform only if one of conditions is satisfied
Report Interval When ACC off	When the vehicle ACC status is off, the system report the position to platform according to the configured report interval

- Platform schedule.  
In the **Report Strategy** list, select **Platform Schedule**. The **Platform Schedule** setting interface is displayed. See Figure 4-89.  
The platform obtains the device position by the configured schedule. The schedule is configured at the Platform. See the User's Manual of the platform.

Figure 4-89 Position report (platform schedule)

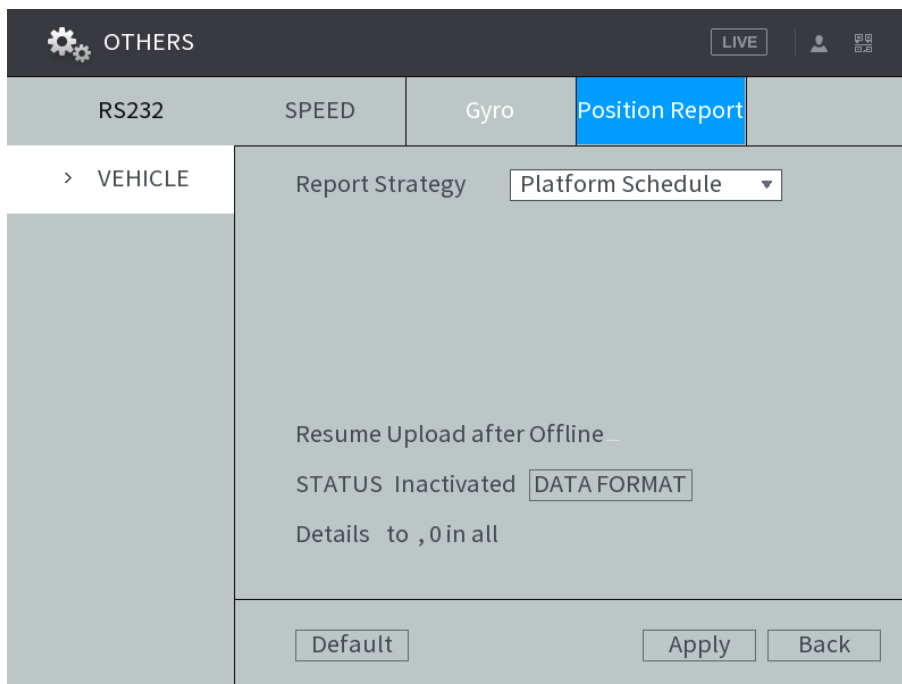

**Step 3** Click **Apply**.

In the **Resume Upload after Offline** area, you can view the resumed upload status after offline and resumed upload details. Click **DATA FORMAT** to clear the resumed upload record.

## 4.7 System Update

### 4.7.1 Viewing system version

Check the device model, software version and other information.

Select **Main Menu > STATUS > VERSION**. The **VERSION** interface is displayed. See Figure 4-90.

Figure 4-90 Version details

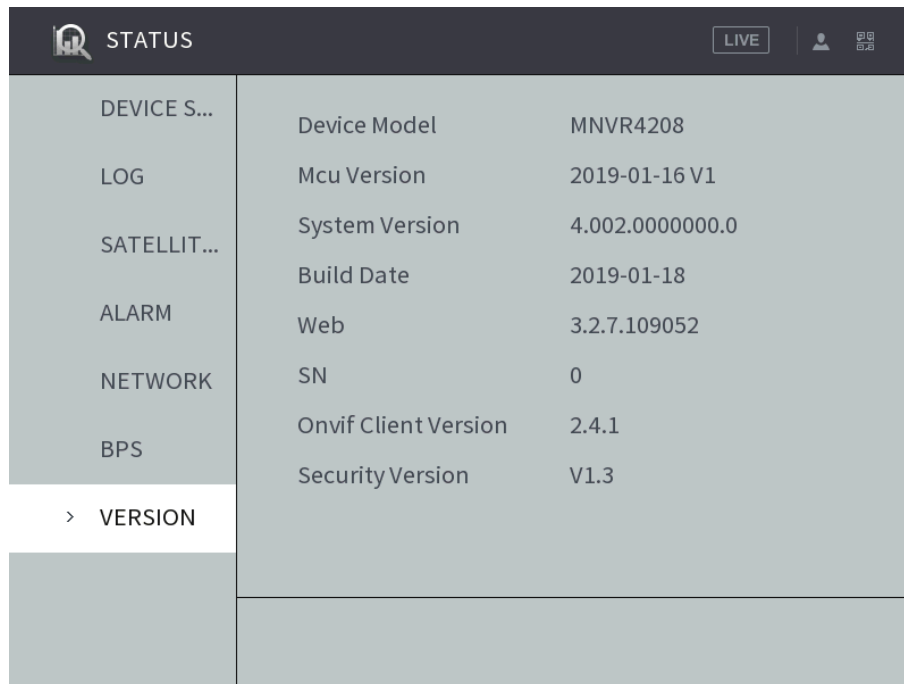

The screenshot shows a web interface with a dark header bar. On the left is a navigation menu with items: DEVICE S..., LOG, SATELLIT..., ALARM, NETWORK, BPS, and > VERSION. The main content area displays system information in a table format. The table has three columns: the first column lists the component, the second lists the version or date, and the third lists the value. The components and their values are: Device Model (MNVR4208), Mcu Version (2019-01-16 V1), System Version (4.002.0000000.0), Build Date (2019-01-18), Web (3.2.7.109052), SN (0), Onvif Client Version (2.4.1), and Security Version (V1.3).

Component	Version/Date	Value
Device Model		MNVR4208
Mcu Version	2019-01-16 V1	
System Version	4.002.0000000.0	
Build Date	2019-01-18	
Web	3.2.7.109052	
SN	0	
Onvif Client Version	2.4.1	
Security Version	V1.3	

## 4.7.2 Upgrading System

Upgrade the system version by importing \*.bin files.

### Preconditions

- The correct version of the upgrade file has been obtained.
- An external storage device (USB flash drive etc.) with upgrade files has been inserted into the device.

### Steps

- Step 1 Select **Main Menu > SYSTEM > UPGRADE**.  
The Upgrade interface is displayed. See Figure 4-91.

Figure 4-91 System update (1)

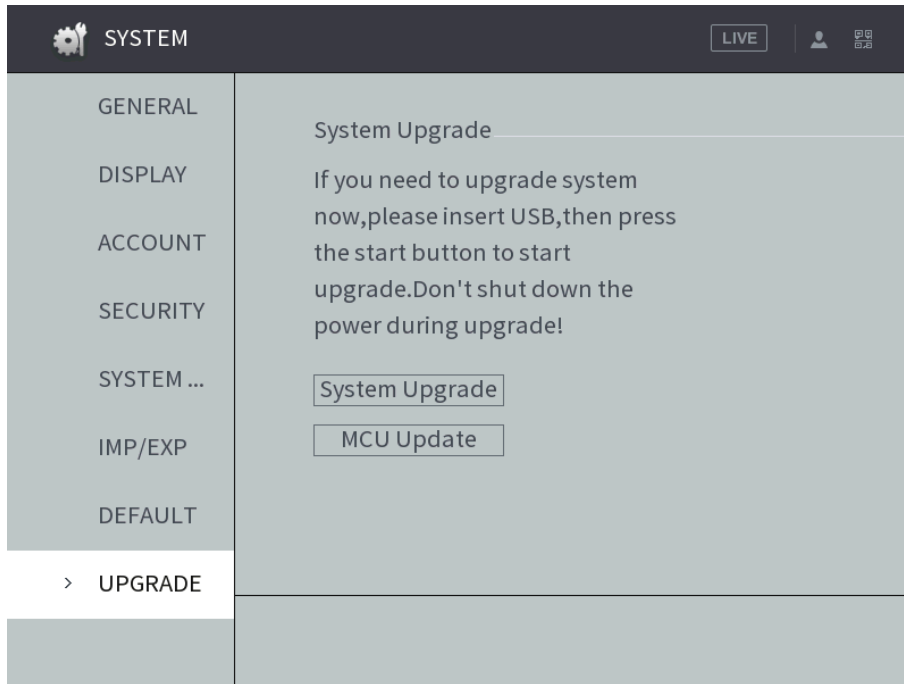

**Step 2** Select an upgrade type to start upgrade.

- Click **System Upgrade** to update the system.
- Click **MCU Update** to update the MCU.

The Upgrade interface is displayed. See Figure 4-92.

Figure 4-92 System update (2)

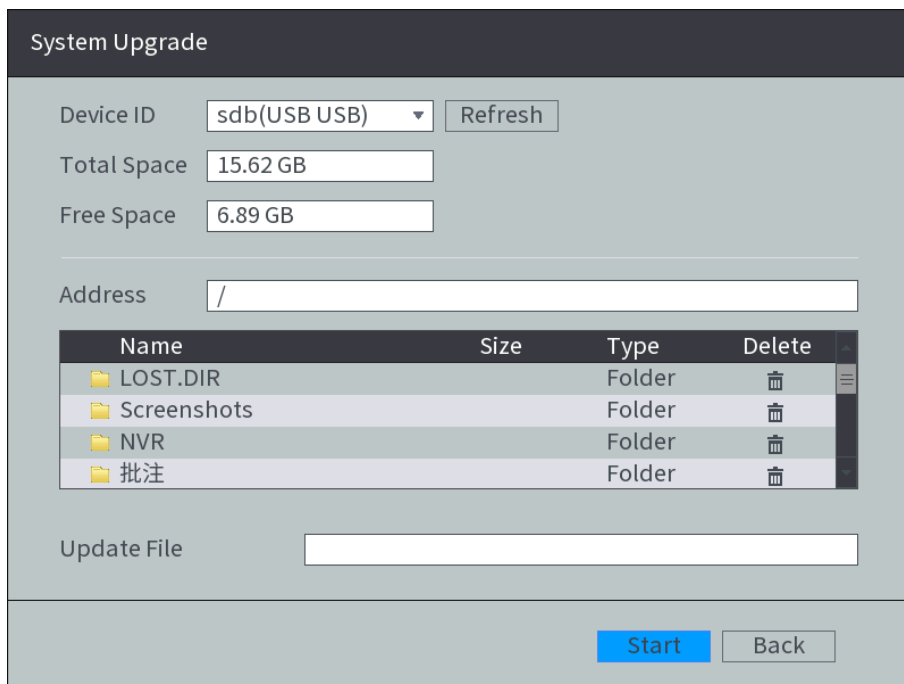

**Step 3** Select the upgrade file, and then click **Start**.

The system starts upgrading.

## 4.8 System Maintenance

### 4.8.1 Requirement for Maintenance

For the system's good and safe running, it's recommended to manage and maintain the system, backup files in the following methods.

- Check surveillance images regularly.
- Clear not frequently-used user and user group regularly.
- Modify your password every 3 months.
- Check your system log regularly. Handle problems asap.
- Backup your configuration of system regularly.
- Reboot this device regularly.
- Upgrade firmwares regularly.

### 4.8.2 Maintaining password

#### 4.8.2.1 Change Password

It is recommended that users modify their passwords regularly to improve the security of the device.

**Step 1** Select **Main Menu > SYSTEM > ACCOUNT > User Setup**.

The User Setup interface is displayed, see Figure 4-93.

Figure 4-93 User Settings

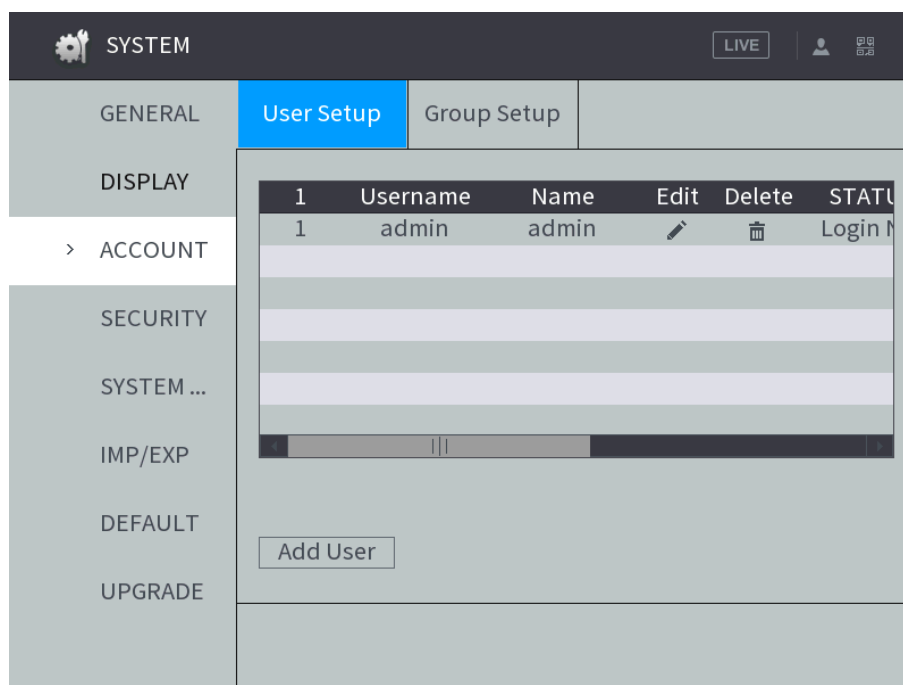

**Step 2** Click .

The **Modify User** interface appears. See Figure 4-94.

Figure 4-94 Modify User

The screenshot shows a 'Modify User' dialog box. At the top, the title is 'Modify User'. Below the title, there are several input fields and controls:

- Username:** A dropdown menu showing 'admin'.
- User MAC:** An empty text input field.
- Modify Pass...:** A password strength indicator showing a dark grey bar.
- Email Address:** A text input field containing '2\*\*\*@qq.com'.
- Old Password:** An empty text input field.
- New Password:** An empty text input field.
- Confirm Pass...:** An empty text input field.
- Prompt Ques...:** A text input field containing 'ty'.
- Group:** A dropdown menu showing 'admin'.
- Memo:** A text input field containing 'admin 's account'.
- Unlock Pattern:** A checkbox that is checked, with a small icon to its right.
- Authority:** A horizontal line above three tabs: 'System' (selected), 'Playback', and 'Monitor'.
- Permissions:** A list of permissions with checkboxes, all of which are checked:
  - All
  - ACCOUNT
  - STORAGE
  - SECURITY
  - SYSTEM
  - EVENT
  - File
  - SYSTE...
  - NETW...
  - DEVIC...
  - MANU...
  - CAMERA
- Buttons:** 'OK' and 'Back' buttons at the bottom right.

**Step 3** Click  after **Modify Password** to enable the function of modifying the password.

**Step 4** Type old password, new password. Then type your new password again to confirm it.

 **NOTE**

- The new password can be set from 8 characters through 32 characters and contains at least two types from number, letter and special characters (excluding ' " ; : Please set a high security password according to the prompt of password strength.
- The user with **Accout** authority can also modify the password of other users.

**Step 5** (Optional) Set up a reserved mobile phone.

Setting up a reserved phone number lets you reset the login password of the admin account if it was lost. See 4.8.2.2 Reset Password.

**Step 6** Click **OK**.

## 4.8.2.2 Reset Password

You can reset the password through the reserved phone number when the password for the admin account is lost.

### Preconditions

The password reset function has been enabled and the reserved mobile phone has been set.

 **NOTE**

When the password reset function is disabled, the password can be reset through the password protection question in the local interface. If the password protection question is not set, all you can do is to have the default setting restored through the hardware reset function.



## Steps

**Step 1** Enter the login interface.

- If you configured unlock pattern, the unlock pattern interface is displayed. Click **Forgot Unlock Pattern**, the password login interface is displayed. See Figure 4-95.
- If you did not configure unlock pattern, the password login interface is displayed. See Figure 4-95.



### NOTE

On the unlock pattern login interface, click **Switch User** to login; or on the password login interface, in the **User Name** list, select another user to login.

Figure 4-95 Login

SYSTEM LOGIN

Username

Password

**Step 2** Click .

The **Message** interface appears. See Figure 4-96.

Figure 4-96 Message

Prompt

In order to provide a secure password reset environment, we need to collect your e-mail address, device MAC address, device SN, etc. All collected info is used only for the purposes of verifying device validity and sending a security code to you. Do you agree and want to continue the operation?

**Step 3** Click **OK**.

- If the reserved phone number was set, the interface is displayed.
- If no reserved phone number was set, set the reserved phone number according to system instructions. Then click Next.

**Step 4** Reset the login password.

- Reset by QR code  
In the Reset Type list, select QR Code, and then follow the onscreen instructions to get the security code in your reserved email address.



- ◇ Scan the QR code on the actual interface of Device.
- ◇ You can get the security code twice by scanning the same QR code. If you need to get the security code once again, please refresh the interface.
- ◇ The security code is valid for 24 hours.
- Security Questions  
In the Reset Type list, select Security Question, the security question interface is displayed. In the **Answer** boxes, enter the correct answers.  
The password can only be reset through the security question after the security question has been set.

**Step 5** Click **Next**.

The Reset the password interface is displayed.

**Step 6** Reset and confirm the password.

The new password can be set from 8 characters through 32 characters and contains at least two types from number, letter and special characters (excluding ', ", ;, :, &).

Enter a strong password according to the security level indication.

**Step 7** Click **OK**.

## 4.8.3 Querying log

You can search, view, and back up the system logs to an external storage device.

### Preconditions

Make sure the external storage device such as USB flash disk is connected to the Device.

### Steps

**Step 1** Select **STATUS > LOG**.

The **LOG** interface is displayed.

**Step 2** Set up **Start Time**, **End Time**, and **Types**.

**Step 3** Click **Search**.

The searched logs are displayed. See Figure 4-97.



- After the external storage device is connected to the device, click **Backup** and select the save path to back up the log to the external storage device.
- Select log records and click **Details** to view log details.

Figure 4-97 Log List

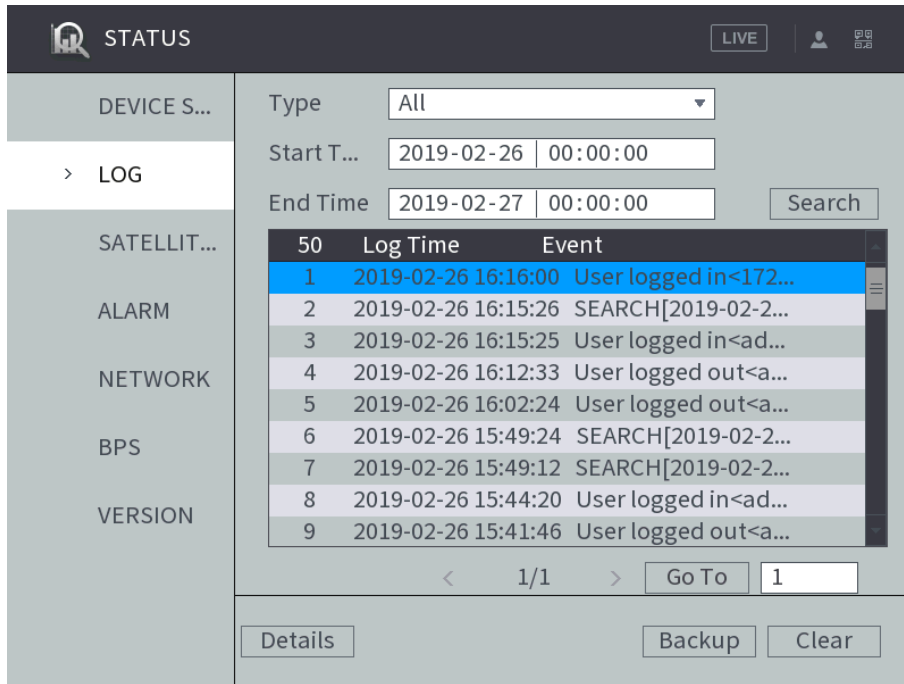

## 4.8.4 Review status information

### 4.8.4.1 Review running status

You can review the running status of the device.

Select **Information > Running Status**. The system displays the ACC status, voltage, temperature, and more. See Figure 4-98.

Figure 4-98 Running status

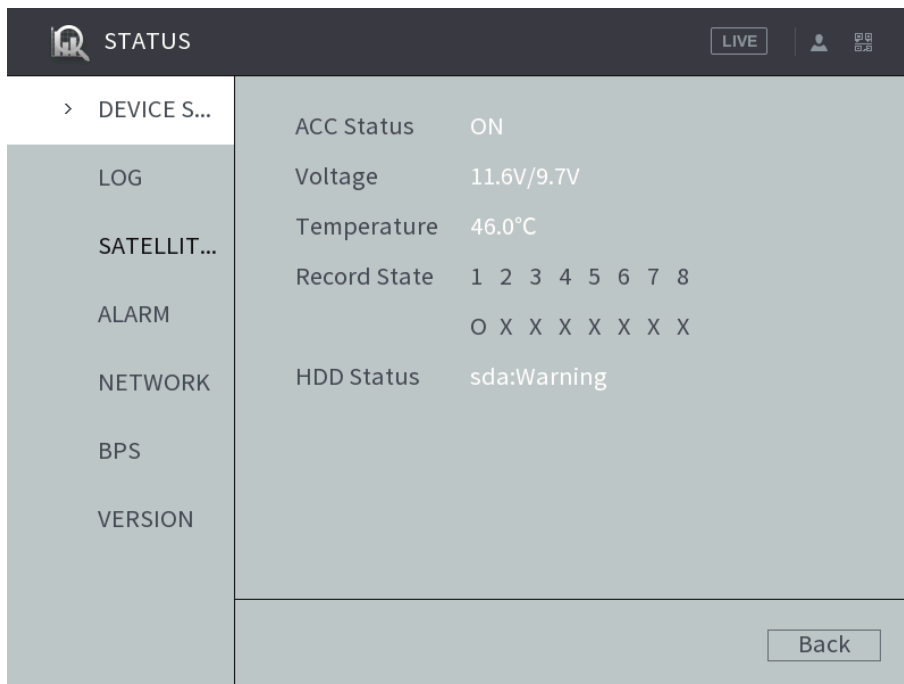

### 4.8.4.2 Viewing Satellite Info

You can view the satellite positioning information such as module state, positioning status, antenna status, latitude and longitude, and search results.

Select **Main Menu > Status Information > SATELLITE INFO**. The SATELLITE INFO interface is displayed. See Figure 4-99.

Figure 4-99 Satellite information

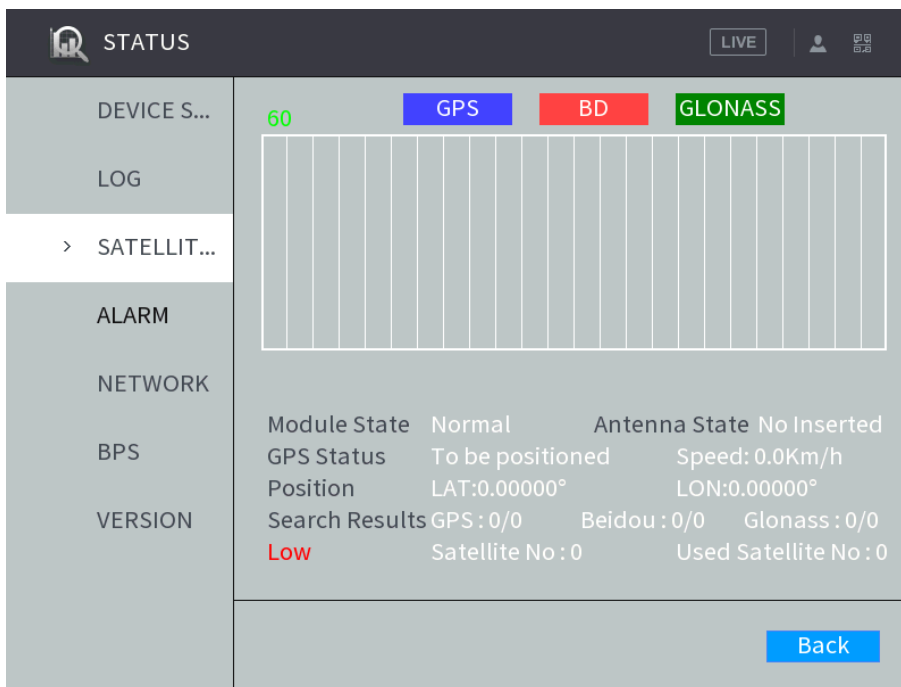

### 4.8.4.3 Viewing alarm status

You can view the alarm status. The alarms of each channel are displayed in the alarm interface.

Select **Main Menu > STATUS > ALARM**. The **ALARM** interface is displayed. See Figure 4-100.

Figure 4-100 Alarm

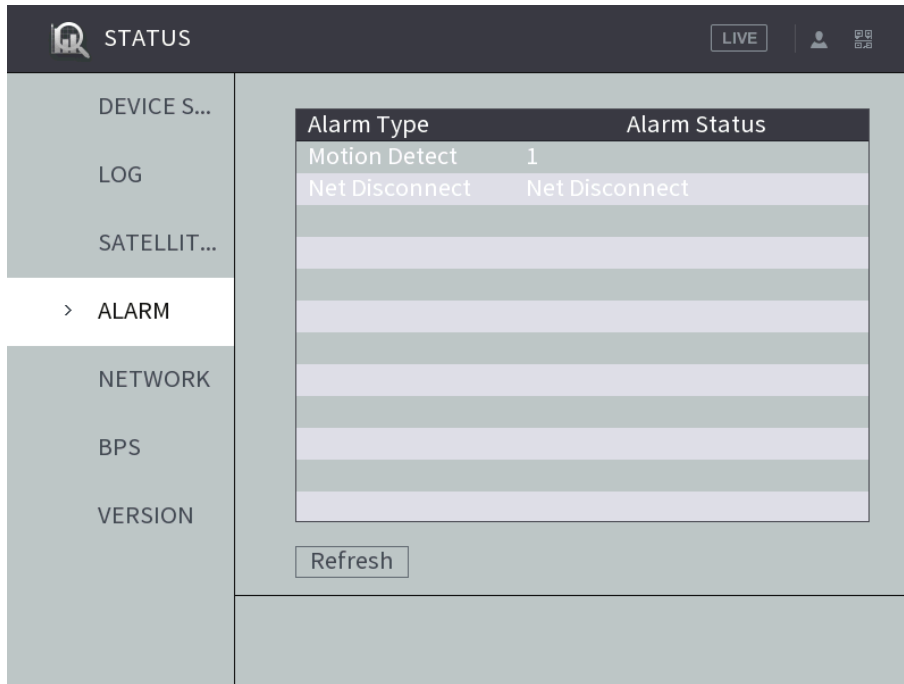

#### 4.8.4.4 Viewing Data Rate Information

You can view the real-time data stream rate and diagram of data rate changes.

Select **Main Menu > STATUS > BPS**. The **BPS** interface is displayed. See Figure 4-101.

Figure 4-101 Viewing Data Rate Information

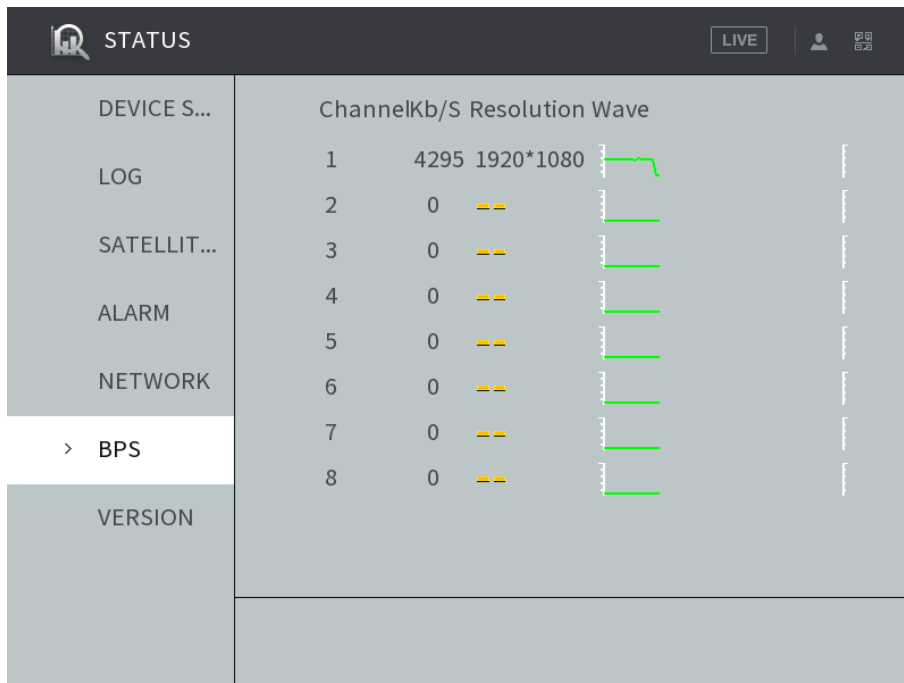

#### 4.8.5 Auto Maintain

You can configure the automatic maintenance settings such as auto reboot, auto booting up or shutdown, and delay for auto shutdown.

### 4.8.5.1 Reboot system

After configuring auto reboot, when the Device is working, it reboots according to the schedule.

**Step 1** Select **Main Menu > SYSTEM > SYSTEM MAINTENANCE**.

The **SYSTEM MAINTENANCE** interface is displayed, see Figure 4-102.

Figure 4-102 Auto Maintain

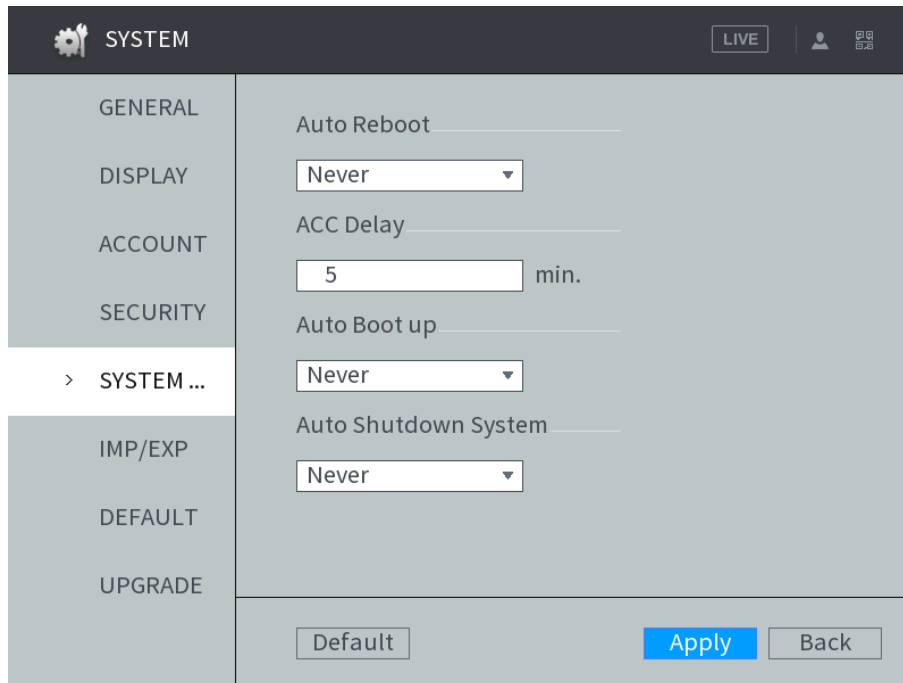

**Step 2** By default, the system never reboots automatically. Select the auto reboot time according to your need.

**Step 3** Click **OK**.

The system auto reboots at the specified time.

### 4.8.5.2 Auto Delay for Shutdown

After configuring auto delay for shutdown, when ACC is disconnected, the Device shuts down according to the settings of auto delay for shutdown.

- If you enter the delay value that is not 0, the Device automatically shuts down after the preset delay.
- If you enter 0, the Device shuts down according to the auto shutdown settings without delay.

**Step 1** Select **Main Menu > SYSTEM > SYSTEM MAINTENANCE**.

The **SYSTEM MAINTENANCE** interface is displayed.

**Step 2** Configure the auto delay for shutdown.

The value ranges from 0 through 65535. The default value is 5 minutes.

**Step 3** Click **OK**.

### 4.8.5.3 Configuring auto boot up

After configuring auto boot up, the Device boots up automatically at the scheduled time. If the vehicle key is turned to the ACC before the preset auto boot up schedule, the device boots up

immediately. When the ACC of the vehicle is off after booting up, the device will be shut down according to the preset automatic shutdown delay time.

Step 1 Select **Main Menu > SYSTEM > SYSTEM MAINTENANCE**.

The **SYSTEM MAINTENANCE** interface is displayed.

Step 2 In the Auto Boot up area, select Valid, and then enter the specific time.

Step 3 Click **OK**.

#### 4.8.5.4 Configuring auto shutdown system

After configuring auto shutdown, the Device automatically shuts down according to the ACC power off time and auto boot up setting.

- If you have set the time for auto boot up, there are two situations when the ACC is powered off: If the system time is between the auto boot up and auto shutdown, the Device is turned off at the configured time. If the system time is before the auto boot up or after the auto shutdown, the Device is turned off immediately.
- If the auto boot up is not set, when the ACC is disconnected, the Device shuts down at the scheduled time.

Step 1 Select **Main Menu > SYSTEM > SYSTEM MAINTENANCE**.

The **SYSTEM MAINTENANCE** interface is displayed.

Step 2 In Auto Shutdown System, select Everyday, and then enter the specific time.

Step 3 Click **OK**.

#### 4.8.6 Backing Up and Restoring

##### 4.8.6.1 Backing up Configurations

You can back up all configuration information.

##### Preconditions

Make sure the external storage device such as USB flash disk is connected to the Device.

##### Steps

Step 1 Select **Main Menu > SYSTEM > CONFIGURE BACKUP**.

The **CONFIGURE BACKUP** interface is displayed. If the external storage device is connected before the interface is entered, the system will automatically identify the information of the external storage device, see Figure 4-103.

If the external storage device is connected after the interface is entered, click **Refresh** and the system will recognize the connected external storage device.

Figure 4-103 IMP/EXP

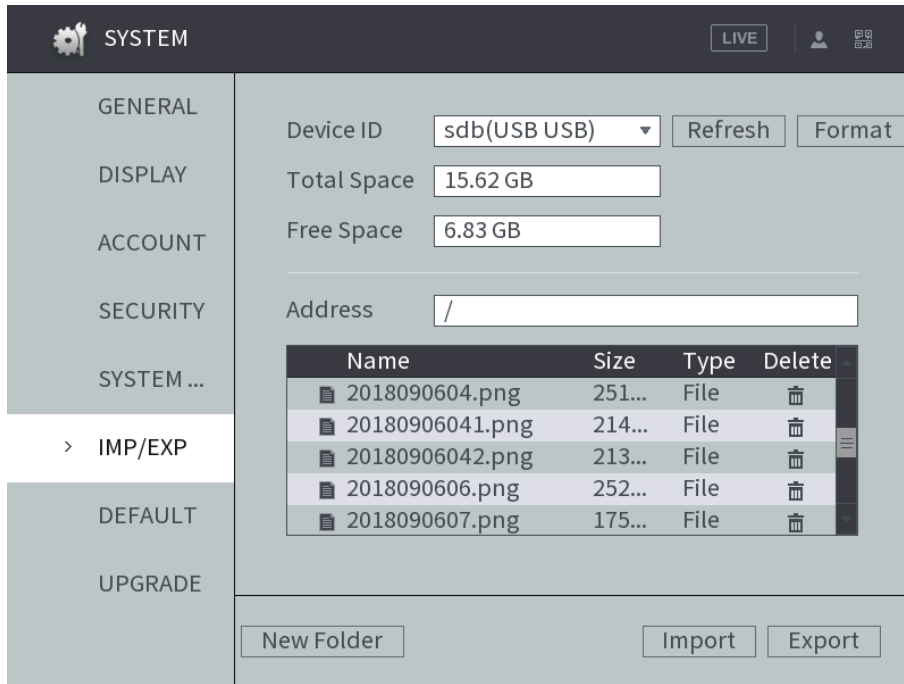

**Step 2** Select the backup path and click **Export**.

The system will pop up a message in case of success. Click **OK** to complete backup.

### 4.8.6.2 Restoring Configurations

**Step 1** Select **Main Menu > SYSTEM > CONFIGURE BACKUP**.

The **CONFIGURE BACKUP** interface is displayed. If the external storage device is connected before the interface is entered, the system will automatically identify the information of the external storage device, as shown in Figure 4-104.

If the external storage device is connected after the interface is entered, click **Refresh** and the system will recognize the connected external storage device.

Figure 4-104 IMP/EXP

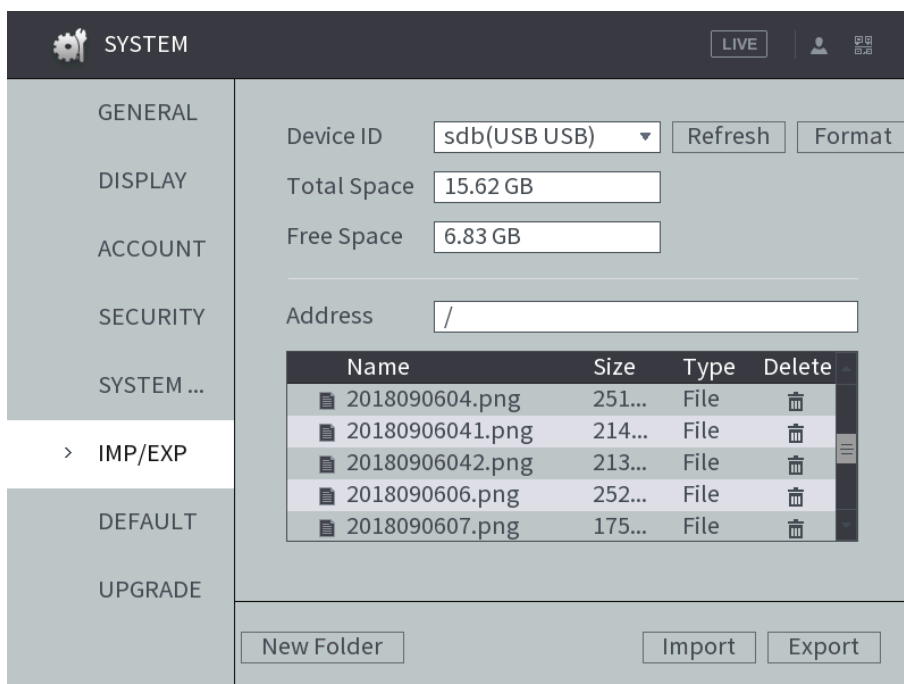



Step 2 Select a file and click **Import**.

After the import is completed, the system prompts that the settings will take effect after reboot. Click **OK**.

The system starts rebooting.

## 4.8.7 Restored to the Default Settings

You can restore the system to default configurations or the factory default. Only the user with the default&upgrade authorities can do this.



The corresponding functions will be restored to the factory settings, and your current configurations will be lost. Proceed with caution.

Step 1 Select **SYSTEM > DEFAULT**.

The **DEFAULT** interface is displayed. See Figure 4-105.

Figure 4-105 Restored to the Default Settings

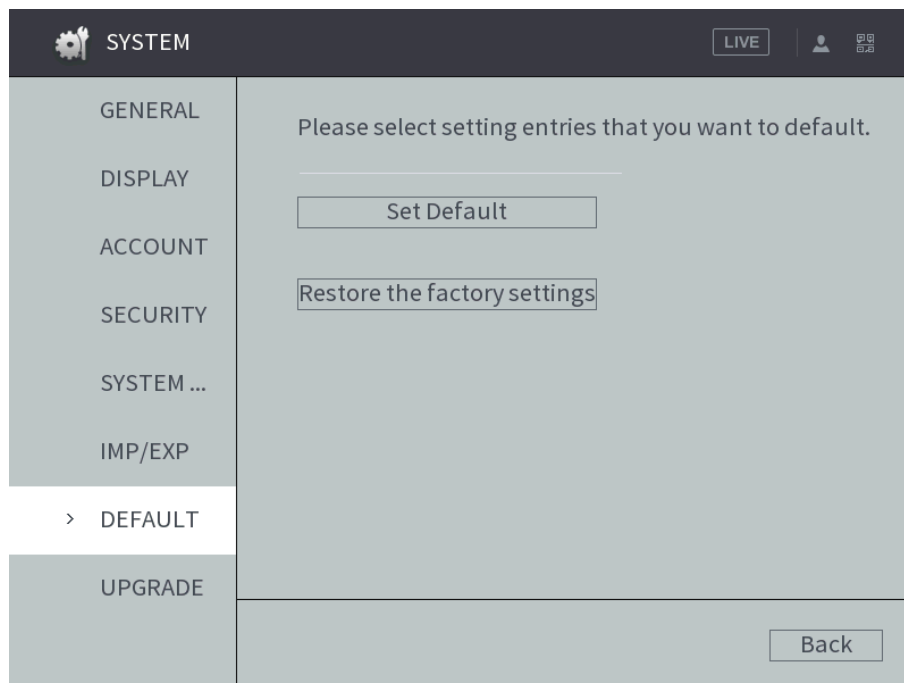

Step 2 Select the check box of the options that you want to restore to the factory default.

- **Default:** Select the options, and then click **Default**. In the pop-up message, click **OK**. The selected options will be restored to the factory default settings.
- **Restore the factory settings:** Click **Restore the factory settings**. In the pop-up message, click **OK**. The system starts rebooting. After the device is rebooted, the system will return to the default settings and needs to be initialized again. Proceed with caution.

When there is a user operating on the local interface, the factory default settings cannot be performed until the local user log out.

## 4.8.8 Network packet capturing

You can back up the network packet to the external storage device. These data can be provided to the developers or engineers to analyze the network usage status.

### Preconditions

Make sure the external storage device such as USB flash disk is connected to the Device.

### Steps

**Step 1** Select **Main Menu > INFO > NETWORK > NET TEST**.

Test **NET TEST** interface is displayed.

**Step 2** Connect the external storage device to the USB port of the Device, and then click **Refresh**.

The system detects the external storage device which displays in the **Device Name** list.

**Step 3** Select the packet.

1) Click **Browse**.

The **Browse** interface is displayed.

2) Select the packet.

#### **NOTE**

- Click **Refresh** to refresh the total space, free space, and device file list.
- When the capacity is insufficient, click  to delete the unnecessary files to release the capacity.
- Click **New Folder** to create a new folder in the external storage device.

3) Click **OK**.

Test **NET TEST** interface is displayed.

**Step 4** Click  to start backing up packet.

#### **NOTE**

- The packet of only one network port can be captured each time.
- When the backing up is started, you can exit the **NET TEST** interface to take other operations, such as web login and monitoring.

**Step 5** Click  to stop backing up.

The packet is stored under the name of "Network card name-time.pcap" in the selected path. You can also back up the packet by Wireshark (a kind of software) on PC.

## 4.8.9 Shutdown

Click **Main Menu >SHUTDOWN**. The **SHUTDOWN** interface is displayed. See Figure 4-106.

- Click **Manual Reboot** and the device is rebooted immediately.
- Click **Logout User** to log out the currently logged-in user.

Figure 4-106 Shutdown

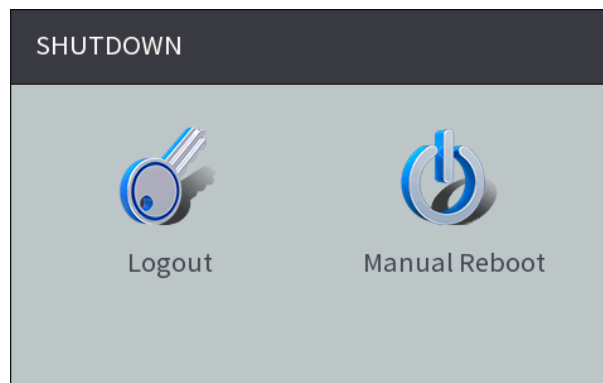

# 5 Web Operations

You can access and operate the Device from web interface on PC client. The web interface comes with the functions such as real-time preview, recording query, settings alarm, configuring system, PTZ control and monitoring screen.

## NOTE

Several browsers are supported, including Chrome, Firefox, and IE.

## 5.1 Initializing Device

When you are opening the device for the first time or you have allowed your system to be restored the factory settings, you need to initialize the device. Only after that can you operate and configure your device.

### Preconditions

Please make sure the correct network connection between PC and the Device.

### Steps

**Step 1** Open the browser, enter the Device IP address (the default IP address is 192.168.1.108), and then press Enter.

The password setting interface is displayed. See Figure 5-1.

Figure 5-1 Password setting

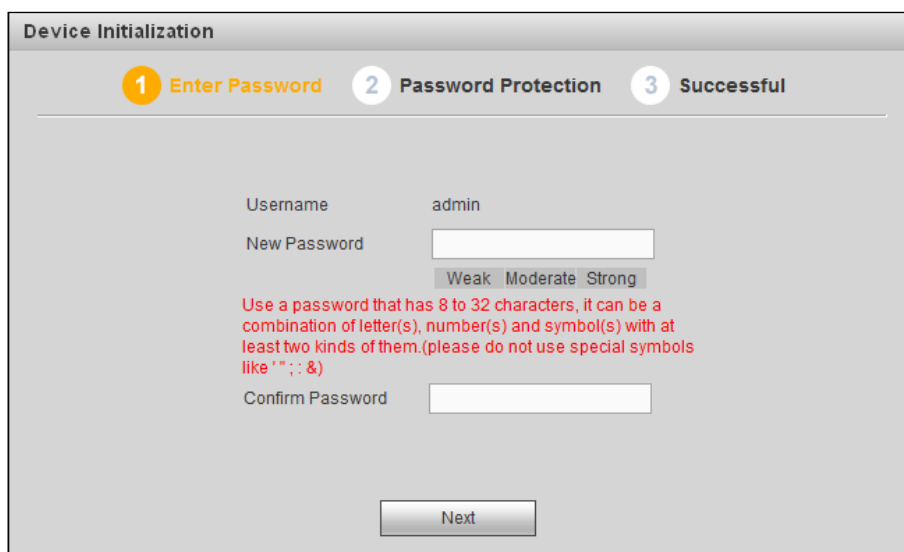

The screenshot shows a web interface titled "Device Initialization". At the top, there are three progress indicators: "1 Enter Password" (highlighted in orange), "2 Password Protection", and "3 Successful". Below the indicators, the "Username" field is pre-filled with "admin". The "New Password" field is empty, with a strength indicator below it showing "Weak", "Moderate", and "Strong" options. A red warning message reads: "Use a password that has 8 to 32 characters, it can be a combination of letter(s), number(s) and symbol(s) with at least two kinds of them. (please do not use special symbols like '": ; &)". The "Confirm Password" field is also empty. A "Next" button is located at the bottom center of the form.

**Step 2** In the **New Password** box, enter the new password and enter it again in the **Confirm Password** box. Click **Next**.

The password protection interface is displayed. See Figure 5-2.

Figure 5-2 Password protection

The screenshot shows a 'Device Initialization' window with three progress indicators at the top: '1 Enter Password', '2 Password Protection' (highlighted in orange), and '3 Successful'. Below the indicators, there are two checked checkboxes: 'Email Address' and 'Security Questions'. Under 'Security Questions', there are three rows, each with a question dropdown and an answer text box. The questions are: 'What is your favorite children's book?', 'What was the first name of your first boss?', and 'What is the name of your favorite fruit?'. A 'Next' button is located at the bottom center.

**Step 3** Select the reset type based on your needs. It is recommended to enable the two types as follows.

- Check the Phone No. box, and then enter the phone number in the box.
- Check the Security Question box, select the question and enter the corresponding answer.

**Step 4** Click **Next**.

The completion interface is displayed. See Figure 5-3.

Figure 5-3 Complete

The screenshot shows the 'Device Initialization' window with the progress indicators: '1 Enter Password', '2 Password Protection', and '3 Successful' (highlighted in orange). The main area of the window displays a green checkmark icon followed by the text 'Successfully initialized the device!'. An 'Ok' button is located at the bottom center.

**Step 5** Click **Save**.

## 5.2 Logging into the Device

You can login to and then configure the device.

**Step 1** Open the browser, enter the Device IP address, and then press Enter.

The Login interface is displayed. See Figure 5-4.

Figure 5-4 Web login interface



**Step 2** Enter Username and Password and click **Login**.

The **PREVIEW** interface is displayed. See Figure 5-5.

Clicking **Exit** can log out.

 **NOTE**

- Install the plugin as prompted by the system for initial login.
- In the upper left corner, the main stream and substream are differentiated by the tab.
- For **admin** account, if you forget password, click **Forgot Password** to find back the password. For details, see 5.5.5.3 Reset Password.

Figure 5-5 Preview interface

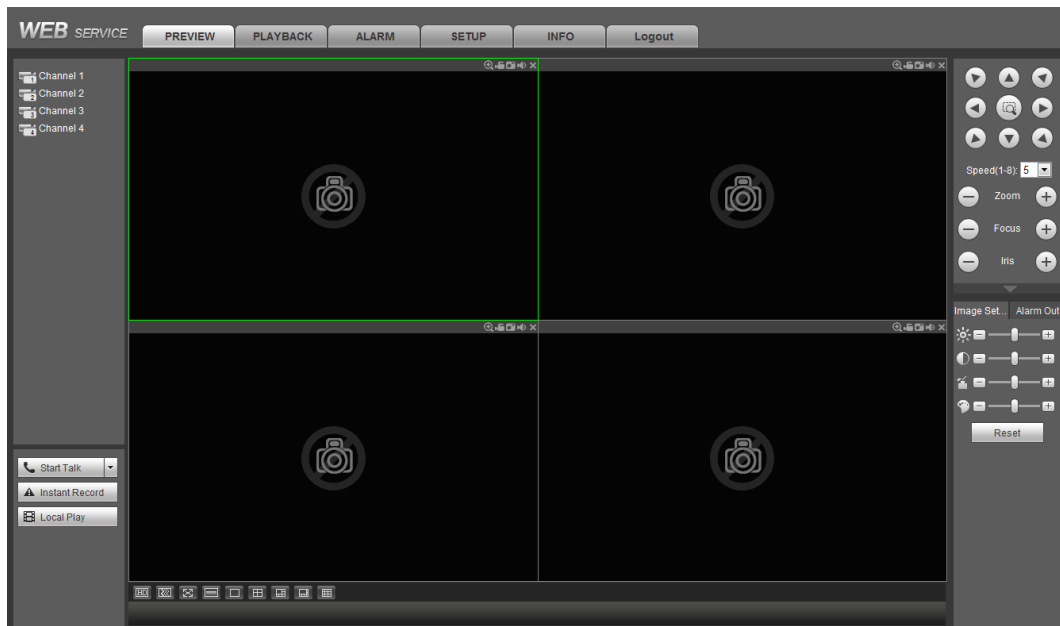

## 5.3 Quick configuring

### 5.3.1 Configure IP address

Connect the Device to the network and make sure the Device can communicate with other devices in the network diagram.

## Preconditions

Make sure the Device is connected to the network properly.

## Steps

**Step 1** Select **Setup > Network > TCP/IP**.

The system displays the **TCP/IP** interface, as shown in Figure 5-6.

Figure 5-6 TCP/IP

**Step 2** Configure TCP/IP parameters. For details, see Table 5-1.

Table 5-1 TCP/IP parameter description

Name	Description
IP Version	Select <b>IPv4</b> or <b>IPv6</b> . Both versions are supported <b>NOTE</b> For IPv6 version, in the <b>IP address</b> box, <b>Default Gateway</b> box, <b>Preferred DNS</b> box, and <b>Alternate DNS</b> box, enter 128 bits and cannot be blank
MAC address	Host's MAC address, cannot be modified
Mode	<ul style="list-style-type: none"> <li>Static You need to manually configure <b>IP Address</b>, <b>Subnet Mask</b> and <b>Default Gateway</b></li> <li>DHCP Obtains IP address automatically With DHCP enabled, <b>IP Address</b>, <b>Subnet Mask</b> and <b>Default Gateway</b> cannot be configured You can check the current IP address whether the DHCP takes effect or not</li> </ul>
IP address	According to your network plan, enter the modified IP address, gateway and subnet mask
Subnet Mask	

Name	Description
Default gateway	 <b>NOTE</b> IP address and gateway must be in the same network segment
Preferred DNS	IP address of the preferred DNS
Alternate DNS	IP address of the alternate DNS
MTU	Displays the MTU value of the Ethernet card. The default setting is 1500 bytes and cannot be changed

Step 3 Click **Save**.

## 5.3.2 Configuring General Settings

You can configure the basic settings, including time and date settings.

### 5.3.2.1 Setting General Information

Set up the general information of the Device, including video recording strategy when the HDD is full, recording length, menu standby duration, license plate, and more.

Step 1 Select **SETUP > SYSTEM > GENERAL > General**.

The General interface is displayed, see Figure 5-7.

Figure 5-7 General

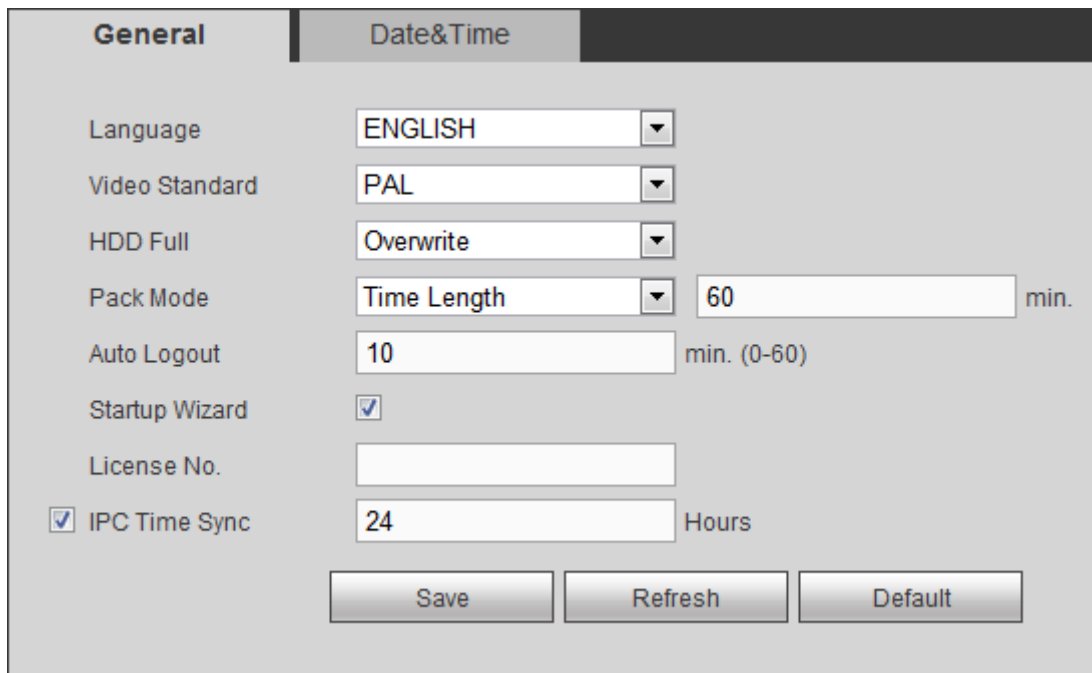

Step 2 Configure TCP/IP parameters. For details, see Table 5-2.

Table 5-2 General settings parameters description

Name	Description
Language	Select a language for the Device system
Video standard	Displays the video encode standard



Name	Description
Disk full	Configure the settings for the situation when HDD is full, including stop and overlap <ul style="list-style-type: none"> <li>Stop: When the HDD is full and there is no extra free disk, the recording stops</li> <li>Overlap: When the HDD is full and there is no extra free disk, the new recorded video overlaps the old videos</li> </ul>
Packaging manner	Enter the length of time for packaging each video file. The maximum length is 120 minutes
Auto Logout	Enter the time period for automatic logout if there are no operations during this period. In this case, you need to login again The value ranges from 0 minutes through 60 minutes. 0 indicates there is not standby time for the Device
Startup Wizard	Set whether to open the software license agreement.
License No.	Enter the license plate number of vehicle where the Device is located
IPC Time Sync	You can select the <b>IPC Time Sync</b> check box and enter the interval for IPC sync with the Device

Step 3 Click **Save**.

### 5.3.2.2 Date and Time Settings

You can configure settings such as date format, time format, and timing mode.

Step 1 Select **SETUP > SYSTEM > GENERAL > Date&Time**.

The **Date&Time** interface is displayed. See Figure 5-8.

Figure 5-8 Date and time settings

Step 2 Configure TCP/IP parameters. For details, see Table 5-3.

Table 5-3 Date and time settings parameters description

Name	Description
Date format	Select a date format
Time format	Select a time format

Name	Description
Time zone	In the <b>Timing Mode</b> list, if <b>GPS</b> or <b>NTP</b> is selected, configure this parameter Configure the Time zone that the device is at
System Time	Displays the current system date and time
Sync PC	Click Sync PC to sync the system time with the PC from where you login the web interface
DST	The DST is applied in some countries or regions. Select the DST check box if it is applied where the Device is located 19. Select the <b>DST</b> check box 20. According to the local regulations, configure the type, begin time and end time for the DST
DST type	
Begin time	
End time	
Timing Mode	Select a timing mode, including DSS, GPS, and NTP. The default selection is NTP <ul style="list-style-type: none"> <li>• DSS: The system time syncs with DSS platform</li> <li>• GPS: The system time syncs with satellite</li> <li>• NTP: The system time syncs with NTP server that you configured</li> </ul>
Server	In the <b>Timing Mode</b> list, if <b>NTP</b> is selected, configure this parameter After configuring NTP server, the Device syncs time with NTP server 21. In the <b>Timing Mode</b> list, select <b>NTP</b> to enable the NTP timing function 22. Configure parameters <ul style="list-style-type: none"> <li>◇ Server: Enter IP address of NTP server</li> <li>◇ Synchronize: Click <b>Synchronize</b> to sync the Device time with NTP server</li> <li>◇ Port: The system supports TCP protocol only and the default setting is 123</li> <li>◇ Interval: Enter the interval that you want the Device to sync time with the NTP server. The maximum value is 65535 minutes</li> </ul>
Synchronize	
Port	
Update period	

Step 3 Click **Save**.

## 5.3.3 Configuring Remote Devices

This section describes how to add cameras to channels. Connect the IPC to the Ethernet port on the rear panel of the Device. You can use a holder or tie strap to fix the port.

### 5.3.3.1 Initializing the Remote Device

Only the initialized remote device can be added. If the remote device that you want to add has been initialized, ignore this section.

#### Preconditions

Make sure the remote device supports initialization.

#### Steps

**Step 1** Select **Setup > CAMERA > REMOTE**.

The **Remote** interface is displayed. See Figure 5-9.

Figure 5-9 Remote device

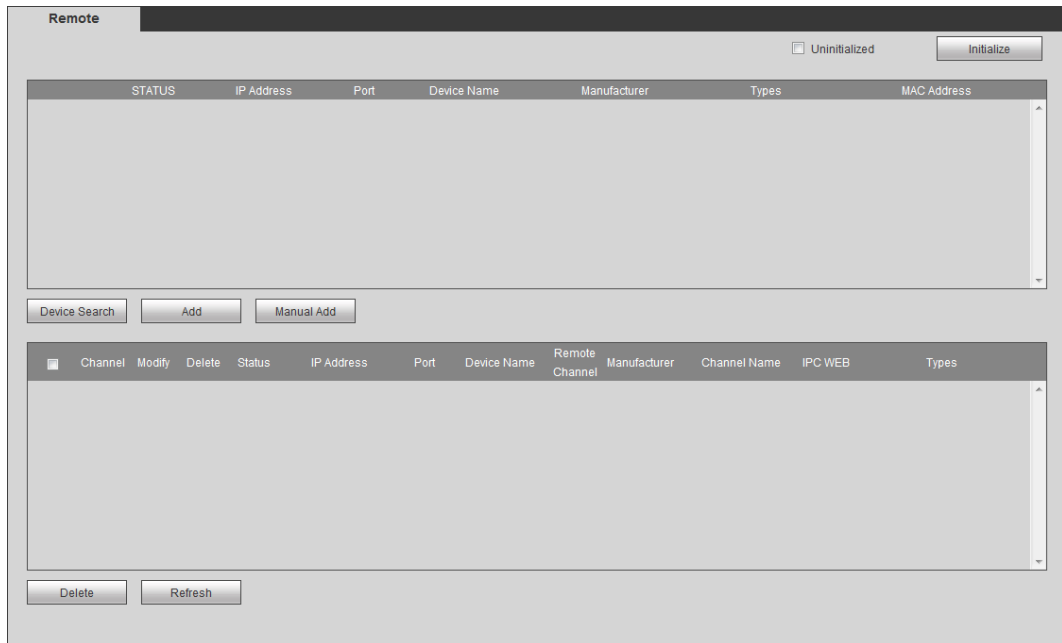

**Step 2** Click **Device Search**.

The searched devices are displayed.

**Step 3** Select the **Uninitialized** check box.

The uninitialized devices are displayed.

**Step 4** Select the check box the uninitialized device, and then click **Initialize**.

The password setting interface is displayed. See Figure 5-10.

Figure 5-10 Password setting

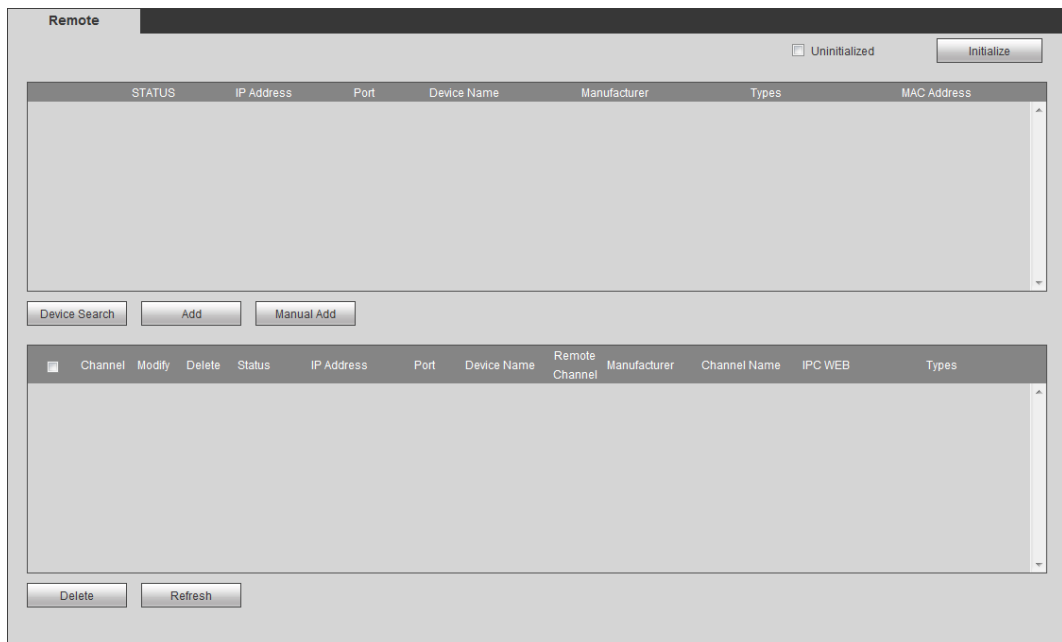

**Step 5** Configure the password by either of the following two ways.

- Using current device password and phone info. Select the **Using current device password and phone info** check box, and the remote device uses the password and phone info of the Device.
- Manually configure password for remote devices.

- 1) Clear the **Using current device password and phone info** check box. The password setting interface is displayed. See Figure 5-11.

Figure 5-11 Set a password.

**Enter Password**

Using current device password and email info.

Username admin

New Password

Weak Moderate Strong

It is 8 to 32-digit containing letter(s), number(s), symbol(s). It contains at least two types.

Confirm Password

Next

- 2) In the **New Password** box, enter the new password and enter it again in the **Confirm Password** box. Click **Next**. The password protection interface is displayed. See Figure 5-12.

Figure 5-12 Password protection

**Password Protection**

Email Address  To reset password, please input properly or update in time

Back Next Skip

- 3) Set up password protection.
  - ◇ Select the **Phone No.** check box, and then enter the phone number. Click **Next**.
  - ◇ Click **Skip** if you do not want to set up password protection.

The Device starts initializing Device. After initialization is completed, see Figure 5-13.

Figure 5-13 Initialization completed

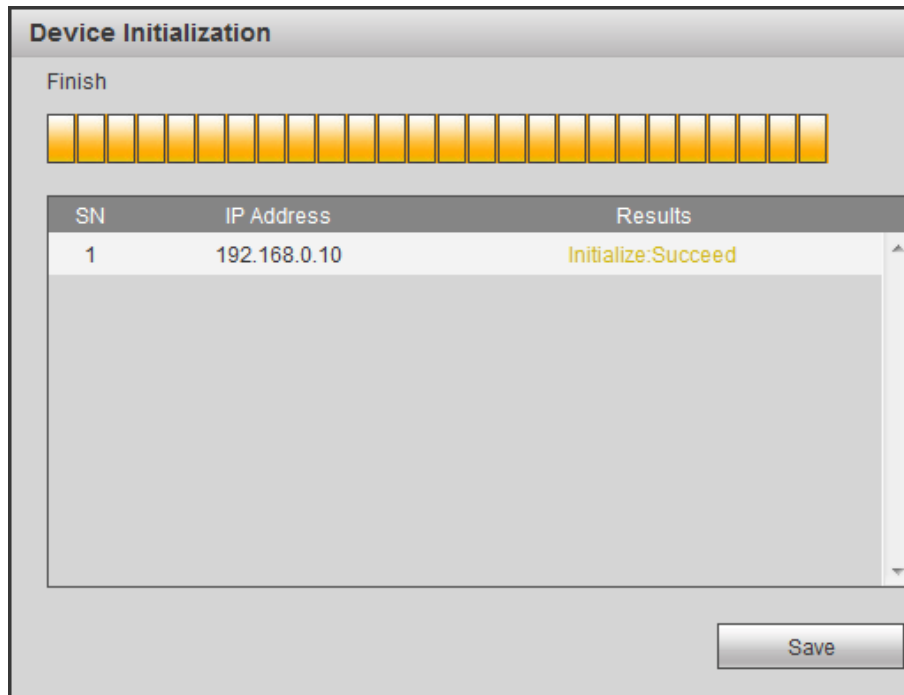

Step 6 Click **Save**.

### 5.3.3.2 Adding a Remote Device

You can add a remote device manually or by search.

Step 1 Select **Setup > CAMERA > REMOTE**.

The **REMOTE** interface is displayed.

Step 2 Adding a remote device.

- Search and Add
  1. Click **Device Search**, the searched devices are displayed.
  2. Double-click on an IP address or select the check box of a device, and then click **Add**.

The device displays in the added device area.
- Manual Add
  1. Click **Manual Add**.

The **Manual Add** interface is displayed. See Figure 5-14.

Figure 5-14 Manual Add

2. Configure TCP/IP parameters. For details, see Table 5-4.

 **NOTE**

The parameters might be different depending on the model you purchased.



Table 5-4 Manual add parameters description

Name	Description
Manufacturer	Select a manufacturer according to the actual situation. Parameters might vary by manufacture. Follow specific parameters on the interface
IP address	Enter the IP address of remote device
TCP Port	TCP service port. The default setting is 37777. You can configure this parameter according to your actual situation
RTSP Port	Enter RTSP Port number of remote device. The default setting is 554
HTTP Port	Enter HTTP Port number of remote device. The default setting is 80
Username	Enter the user name and password to login to the remote device
Password	
Remote Channel	Select the channel number that you want to connect
Channel	The channel number of the remotely connected device. You can only select a channel that has not added remote devices
Decode buffer	Enter the size of decode buffer. The unit is millisecond and you can select from 80 through 480
Service type	This must be set up when you select <b>Onvif</b> or <b>Custom</b> as the <b>Manufacturer</b> When selecting different manufacturers, the service types are different. Select the service type based on your needs

3. Click **Save**.

The device displays in the added device area.

 **NOTE**

-  indicates connection is successful;  indicates connection failed.

- To delete an added device, select it, and then click **Delete**; to modify the information of an added device, click  or double-click the device.

### 5.3.4 Configuring Record Settings

The record mode is consisted of manual mode and auto mode. You can also enable or disable the snapshot function.

- Auto: The recording starts automatically according to the record type and recording time as configured in the recording schedule.
- Manual: Keep general recording for 24 hours for the selected channel.

#### CAUTION

Manual recording operation requires the user have the permission to access **STORAGE** settings. Check to ensure the HDD installed in the Device has been formatted properly.

Step 1 Select **Setup > Storage > Record**.

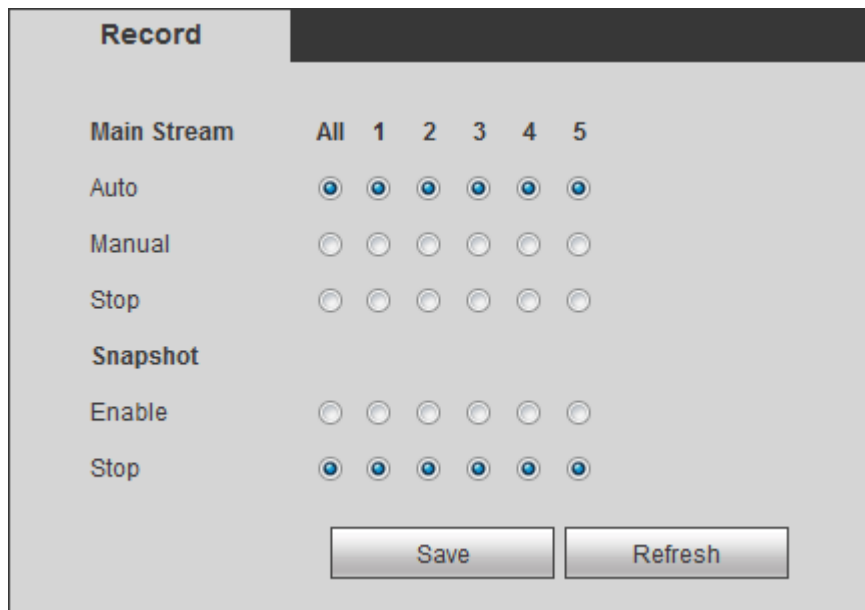

The Record interface is displayed, see Figure 5-15.

Figure 5-15 Record



Step 2 Configure TCP/IP parameters. For details, see Table 5-5.

Table 5-5 Record control parameter description

Name	Description
Channel	Displays the channel number You can select one or several channels or select <b>All</b>
Status	Indicates the recording status of corresponding channels. The choices include Auto, Manual, Enable, and Stop <ul style="list-style-type: none"> <li>•  : Selected</li> <li>•  : Not selected</li> </ul>

Name	Description
<b>Auto/Manual/Stop</b>	Select the recording mode, including Manual, Auto, and Stop <ul style="list-style-type: none"> <li>● Manual: Top priority. When the <b>Manual</b> check box is selected, the system keeps general recording for 24 hours for the corresponding channel</li> <li>● Auto: The system starts recording according to the record type (such as general alarm, motion detect, and system alarm) and recording time</li> <li>● Stop: Do not record</li> </ul>
Enable/Stop	Enable or disable the scheduled snapshot for the corresponding channels

Step 3 Click **Save**.

## 5.3.5 Set up the storage plan

### 5.3.5.1 Configuring Recording Schedule

The default recording setting is 24 hours recording for all channels. You can configure the record type and recording time according to your actual situation.

#### Preconditions

The auto recording is enabled for the corresponding channel. For details, see “5.3.4 Configuring Record Settings.”

#### Steps

Step 1 Select **Setup > Storage Management > Storage Plan > Record**.

The **Record** interface is displayed. See Figure 5-16.



Figure 5-16 Record Plan

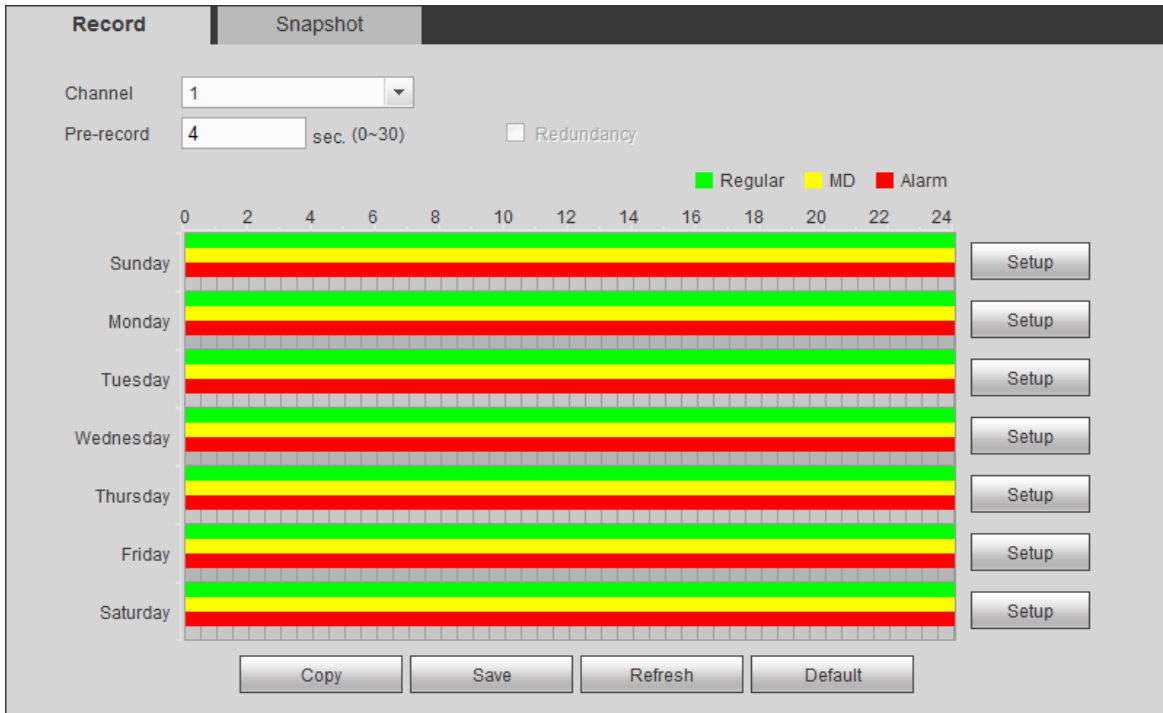

**Step 2** Configure TCP/IP parameters. For details, see Table 5-6.

Table 5-6 Record schedule parameters description

Name	Description
Channel	Select a channel to configure the corresponding recording schedule. To configure the same setting for all channels, select <b>All</b>
Pre-record	Start recording for 0 seconds to 30 seconds before the alarm event occurs. If you enter 0 seconds, there will be no pre-recording

**Step 3** Configure the recording time period.

- 1) Click **Setup** corresponding to the week.  
The Settings interface is displayed. See Figure 5-17.

Figure 5-17 Settings

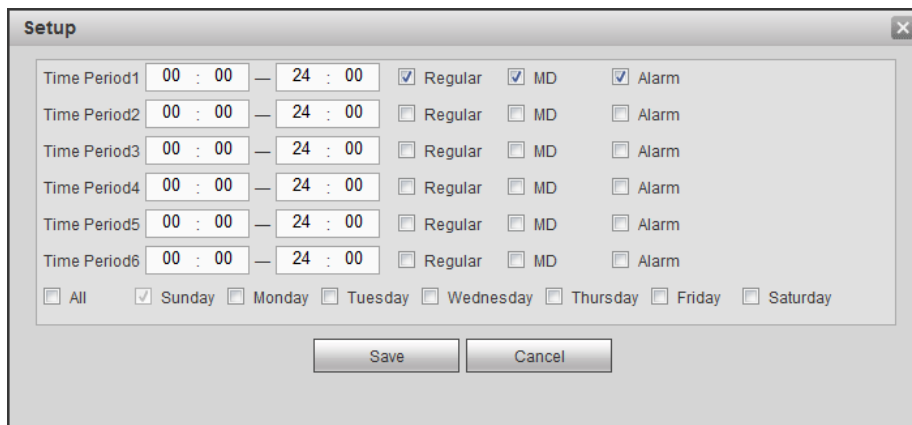

- 2) Select the record type and weekday, and enter the recording period.

**NOTE**

If the **MD** check box and the **Alarm** check box are selected, the corresponding alarm linkage should be enabled. For details, see 5.5.3Set alarm information. For

example, if the alarm type is **MD**, select **Enable Channel**, and select the recording channel.

3) Click **Save**.

The recording schedule appears on the **Record** interface to view the configured recording schedule directly.

Step 4 Click **Save**.



**NOTE**

Click **Copy to** and you can copy the settings to other channels.

### 5.3.5.2 Configure snapshot schedule

You can configure the storage schedule for taking the snapshot.

#### Preconditions

The Snapshot is enabled for the corresponding channel. For details, see “5.3.4 Configuring Record Settings.”

#### Steps

Step 1 Select **Setup > Storage Management > Storage Plan > Snapshot**.

The Snapshot interface is displayed. See Figure 5-18.

Figure 5-18 Snapshot

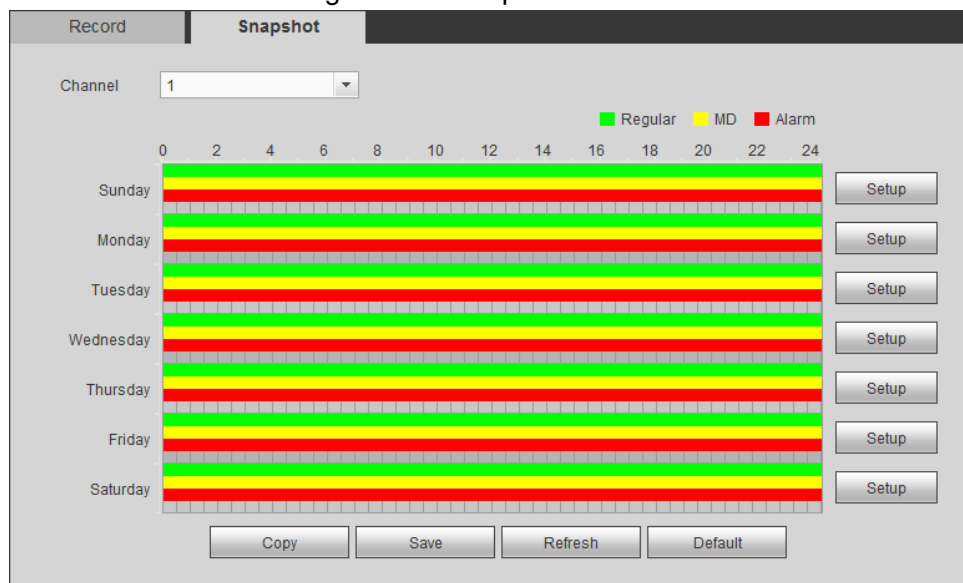

Step 2 Configuring time period for taking snapshots.

1) Click **Setup**.

The Settings interface is displayed. See Figure 5-19.

Figure 5-19 Settings

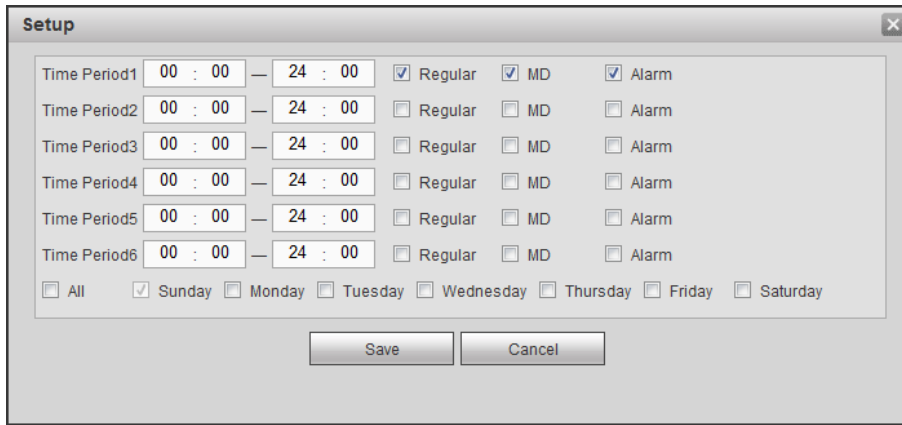

- 2) Select the snapshot type and weekday, and enter the period for taking snapshot.
- 3) Click **Save**.  
Snapshot schedule appears on the **Snapshot** interface to view the configured snapshot schedule directly.

Step 3 Click **Save**.

## 5.4 Common operations

### 5.4.1 Live View

After you logged in the web interface, the **PREVIEW** interface is displayed. See Figure 5-20.

Figure 5-20 Preview interface

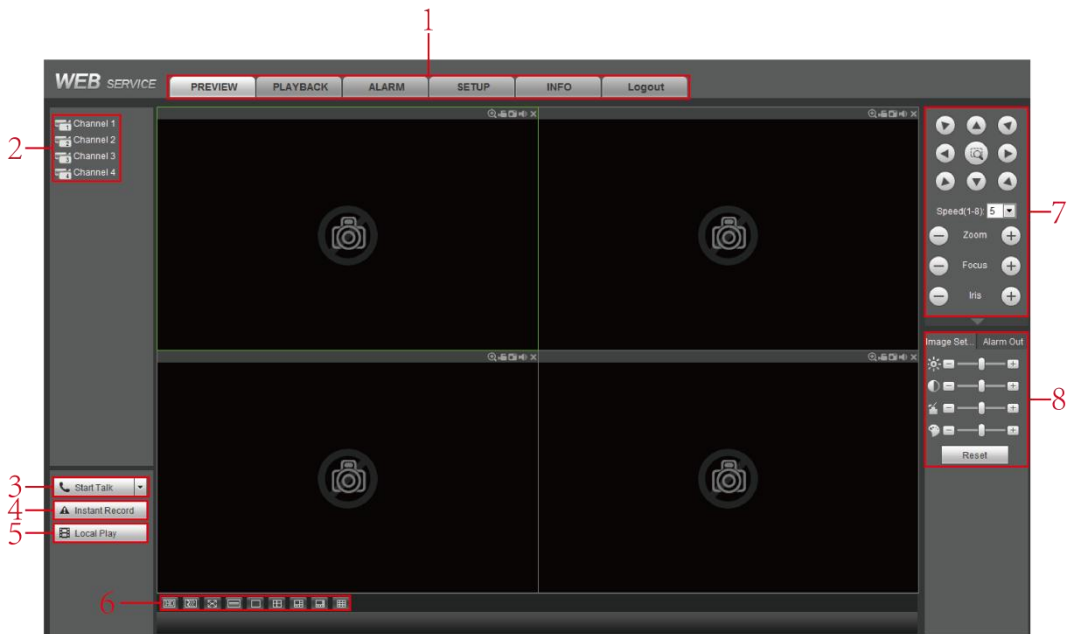





Table 5-7 Preview interface parameters description

Parameter	Description
Preview Interface	Includes PREVIEW, PLAYBACK, ALARM, SETUP, INFO, and LOGOUT

e	Description
-time Monitoring Channels	See "5.4.1.2Real-time Monitoring Channels" for specific steps.
talk	See "5.4.1.3Voice intercom" for specific steps.
nt ord	<p>Click <b>Instant Record</b> and the recording type switches to Manual, when the icon turns to ; click <b>Instant Record</b> again to switch the record type back to Auto</p> <p> <b>NOTE</b> This function is only supported by main stream.</p>
l back	<p>Plays back the video file (.dav) stored on the PC.</p> <p>Click <b>Local Playback</b>, select the video file in the pop-up dialog box, and then click <b>Open</b> to start playing back the video file</p>
ow tion ations	<ul style="list-style-type: none"> <li>• Configure the image quality, playback fluency, full screen, vertical sync, and window split mode.</li> <li>• For real-time monitoring, you can select the fluency or real-time to be the priority according to your actual requirement.</li> <li>• Select  to split the preview window as necessary</li> </ul>

**Description**

See "5.4.1.4PTZ Console

You can perform the operations through PTZ control panel, such as PTZ directions, speed, zoom, focus, iris, preset, tour, pattern, scan, horizontal rotate, auxiliary functions, light, wiper, and defrost.



- PTZ support rotating device toward eight directions, up, down. Left, right, left up, right up, left down, right down.
- Speed function controls the movement speed. For example, the rotation with the step length at 8 is faster than the rotation with the step length at 1.
- Click / to display or hide the **PTZ** settings and **PTZ** menu functions.

Figure 5-21 PTZ Console



**5.4.1.1.2 PTZ**

You can configure scan, preset, tour, pattern, and auxiliary functions.

Figure 5-22 PTZ

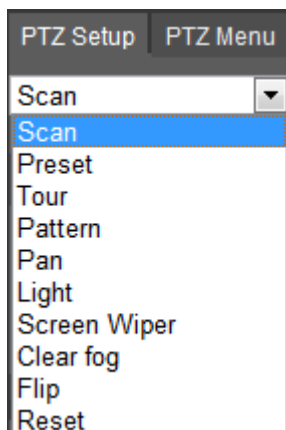

e	Description
e ng/Alarm ut	See "5.4.1.5Image and Alarm out Settings" for specific steps.

### 5.4.1.2 Real-time Monitoring Channels

Displays the list of monitoring channels.

Figure 5-24 Monitoring channels

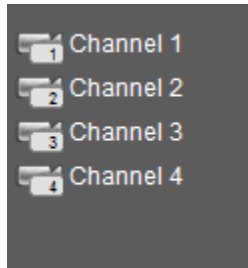

### Operations in monitoring channels

Click any monitoring channel to display its live video on the screen. See Figure 5-25.

Figure 5-25 Video monitoring screen

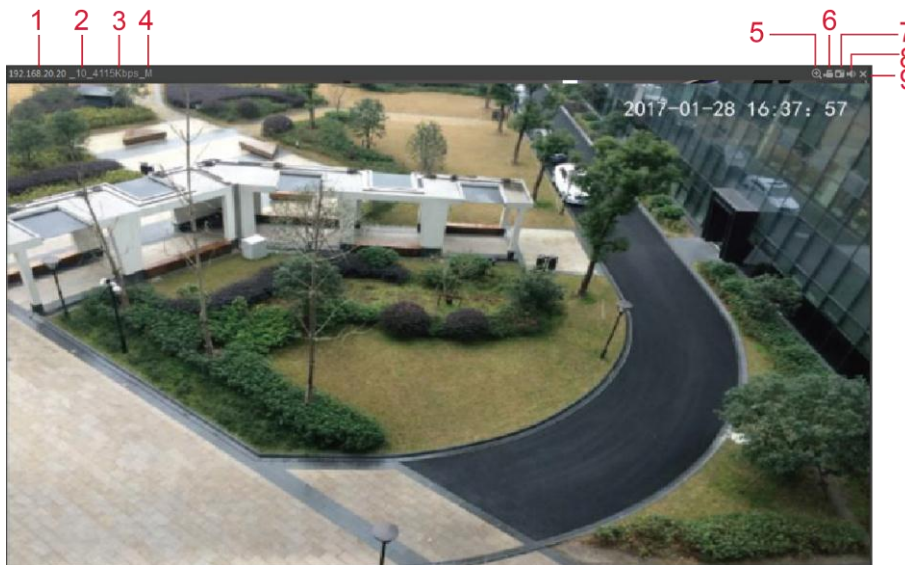



Table 5-11 Video monitoring window parameters description

No.	Parameter	Description
1-4	Device information	Displays the IP address, channel number, bit stream, and stream type (M represents main stream, S represents sub stream)
5	Area zoom in	Click this icon and then hold down the left mouse button to select the area you want to enlarge. The area is enlarged. Click this icon again or right-click on the window to exit

No.	Parameter	Description
6	Local Record	Click this icon to start recording; click it again to stop recording  <b>NOTE</b> The recorded files default storage path is C:\RecordDownload. You can modify this path if needed. For details, see "5.5.1.2.4Path."
7	Snapshot	Click this icon to start taking snapshot.  <b>NOTE</b> The snapshots default storage path is C:\PictureDownload. You can modify this path if needed. For details, see "5.5.1.2.4Path."
8	Audio	Turns on/off audio. If audio function is not enabled in the encode settings, the monitoring does not give sound
9	Close	Close the live view in the window.

## Bit rate

The system supports switching between main stream and sub stream in real-time monitoring window. See Figure 5-26. For details about stream settings, see 5.5.1.2Configuring encode parameters.

Figure 5-26 Bit rate

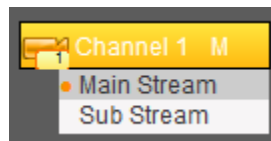

### 5.4.1.3 Voice intercom

You can do the two-way voice talk between the Device and Client.

Figure 5-27 Voice intercom

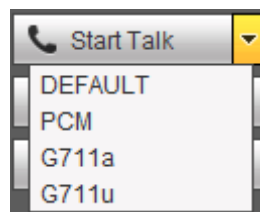

- Click **Start Talk** to enable the voice talk between the Device and Client.
- Click the drop-down list to select the voice talk mode. Available options include: DEFAULT, PCM, G711a, and G711u.
- After enabling voice talk, the **Start Talk** icon turns to . Click **Stop Talk** if you want to end the talk.

### 5.4.1.4 PTZ Console

You can perform the operations through PTZ control panel, such as PTZ directions, speed, zoom, focus, iris, preset, tour, pattern, scan, horizontal rotate, auxiliary functions, light, wiper, and defrost.



- PTZ support rotating device toward eight directions, up, down. Left, right, left up, right up, left down, right down.
- Speed function controls the movement speed. For example, the rotation with the step length at 8 is faster than the rotation with the step length at 1.
- Click / to display or hide the **PTZ** settings and **PTZ** menu functions.

Figure 5-28 PTZ Console



### 5.4.1.4.2 PTZ

You can configure scan, preset, tour, pattern, and auxiliary functions.



Figure 5-29 PTZ

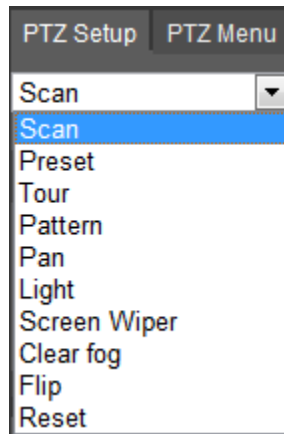



Table 5-12 PTZ functions settings parameters

Parameter	Description
Scan	<p>After setting up scan, the camera automatically scans the configured left border and right border</p> <p>39. In the <b>PTZ Setup</b> list, select <b>Scan</b>, and then click <b>Setup</b>. Two buttons of <b>Set the left border</b> and <b>Set the right border</b> are displayed.</p> <p>40. Through the PTZ control panel, move the camera to the left border that you want and click Set the left border; move the camera to the right border that you want and click Set the right border. Configuration finished.</p> <p>41. Click <b>Start</b> to start scanning; click <b>Stop</b> if you want to end scanning</p>
Preset point	<p>You can quickly move the PTZ camera to the configured presets after configuration. In the PTZ Setup list, select Preset, and then move the camera to the direction that you want to monitor</p> <p>42. Click <b>Preset</b>, and control the PTZ console to turn the camera to the target monitoring direction</p> <p>43. In the Preset box, enter the preset value.</p> <p>44. Click <b>Add</b> to complete adding preset.</p> <p>45. In the Preset box, enter the preset value, and then click <b>Go to</b>, the camera moves to the location of preset. Click <b>Del</b> to delete the preset.</p>
Calling Tours	<p>The PTZ camera repeats performing tours among the configured presets after configuration.</p> <p>46. Click <b>Tour</b> and set up the value of the tour</p> <p>47. Click <b>Add</b>, and then enter the preset value</p> <p>48. Click <b>Add Preset</b> or <b>Del Preset</b> to add or delete the presets</p> <p> <b>NOTE</b> You can do this repeatedly to add presets to delete presets from the tour</p> <p>49. Enter the tour value, and then click <b>Start</b>. The camera starts rotating according to the configured tour. Click <b>Del</b> to delete the tour.</p>

Parameter	Description
Touring pattern	<p>The PTZ camera repeats movement according to the configured patterns. The operation records include the information such as the manual operations and focus adjustment</p> <p>50. Click <b>Pattern</b> and enter the pattern value</p> <p>51. Click <b>Add</b>. Two buttons of <b>Start Rec</b> and <b>Stop Rec</b> are displayed.</p> <p>52. Click <b>Start Rec</b>. Then operate the PTZ control panel to adjust the camera with regard to the parameters such as monitoring direction, zoom, and focus.</p> <p>53. Click <b>Stop Rec</b> to complete the touring pattern setting.</p> <p>54. Enter the pattern value, and then click <b>Start</b>. The camera moves according to the configured patterns. Click <b>Stop</b> to stop the pattern.</p>
Pan	In the <b>PTZ Setup</b> list, Click <b>Pan</b> , and then click <b>Start</b> . The camera keeps rotating with 360° horizontally. Click <b>Stop</b> to stop rotating.
Light	<p>Controls the light of external device through RS-485 command. To use this function, make sure it is supported on the external device</p> <p>In the <b>PTZ Setup</b> list, Click <b>Light</b>. Click <b>On</b> to turn on the light, and click <b>Off</b> to turn off the light.</p>
Wiper	<p>Controls the screen wiper of external device through RS-485 command. To use this function, make sure it is supported on the external device.</p> <p>In the <b>PTZ Setup</b> list, Click <b>Screen Wiper</b>. Click <b>On</b> to turn on the screen wiper, and click <b>Off</b> to turn off the screen wiper.</p>
Clear fog	<p>Controls the warming-up module of external device through RS-485 command. To use this function, make sure it is supported on the external device</p> <p>In the <b>PTZ Setup</b> list, Click <b>Clear fog</b>. Click <b>On</b> to turn on the warming-up module, and click <b>Off</b> to turn off the warming-up module.</p>
Using Flip function	Select and click <b>Flip</b> if you want to flip display the video image
Reset	Click <b>Reset</b> to reset the PTZ

#### 5.4.1.4.3 PTZ menu

After the PTZ menu is turned on, it displays on the monitoring window. You can configure the settings for the options such as camera, PTZ, and system, and apply the settings through arrow buttons and **Save** button.

#### NOTE

This function is supported only on the camera with PTZ menu function.

**Step 5** Turn on the camera monitoring screen.



**Step 6** On the PTZ control interface, click the **PTZ Menu** tab.

The **PTZ Menu** is displayed.

Figure 5-30 PTZ menu



Table 5-13 PTZ menu parameters description

Parameter	Description
	Up and down buttons: Select the item that is pointed
	Left and right buttons: When the item is pointed, perform configurations to the item
Open	Click <b>On</b> to turn on the <b>PTZ menu</b> that is displayed on the monitoring window
Off	Click <b>Off</b> to turn off the <b>PTZ menu</b>
Save	The <b>Save</b> button provides the following functions <ul style="list-style-type: none"> <li>• If there is sub-menu for an item, click <b>Save</b> to enter the sub-menu</li> <li>• Move the pointer to <b>Return</b>, and then click <b>Save</b> to return to the higher level menu</li> <li>• Move the pointer to <b>Exit</b>, and then click <b>Save</b> to exit the menu</li> </ul>

Step 7 Click **On**.

The OSD menu is displayed on the monitoring screen.

Table 5-14 OSD menu parameters description

Parameter	Description
Camera	Move the pointer to <b>Camera</b> , and then click <b>Save</b> to enter the sub-menu of <b>Camera</b> You can configure the camera parameters such as image, exposure, backlight, white balance, day & night, zoom, and focus.
PTZ	Move the pointer to <b>PTZ Setup</b> , and then click <b>Save</b> to enter the sub-menu of <b>PTZ Setup</b> You can configure the PTZ parameters such as preset, tour, scan, pattern, pan, and reboot
System Manager	Move the pointer to <b>System</b> , and then click <b>Save</b> to enter the sub-menu of <b>System</b> . You can configure the settings such setting analog PTZ, restoring factory default, and viewing camera version and PTZ version.
Back	Move the pointer to <b>Return</b> , and then click <b>Save</b> to return to the higher level menu
Exit	Move the pointer to <b>Exit</b> , and then click <b>Save</b> to exit the menu

Step 8 Click **Off** to turn off the PTZ menu.

## 5.4.1.5 Image and Alarm out Settings

For each channel, you can configure the image settings such as adjusting brightness and contrast, and enable or disable the alarm out.

### 5.4.1.5.1 Configuring Image settings

You can adjust the video image color effect such as brightness, contrast, saturation, and hue by clicking on the channel.

**Step 1** Click on a live view channel window to select it.

**Step 2** Click the **Image Setup** tab.

The **Image Setup** interface is displayed. See Figure 5-31.

Figure 5-31 Image setup

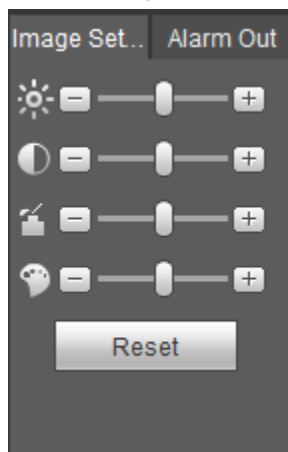

**Step 3** Configure TCP/IP parameters. For details, see Table 5-15.

Table 5-15 Image setting parameters description

Name	Description
Brightness	Adjusts the image brightness. The bigger the value is, the brighter the image will become
Contrast	Adjusts the contrast of the images. The bigger the value is, the more obvious the contrast between the light area and dark area will become
Saturation	Adjusts the color darkness. Adjust the saturation according to the actual situation. The bigger the value, the lighter the color will become
Hue	Adjusts the image brightness. Adjust the saturation according to the actual situation. The bigger the value, the brighter the image will become
Reset	Click Reset to clear the existing image settings

### 5.4.1.5.2 Configuring Alarm Output Settings

Turn on or off the alarm signal of corresponding channel.

**Step 1** Click on a live view channel window to select it.

**Step 2** Click the **Alarm Out** tab.

The **Alarm Out** interface is displayed. See Figure 5-32.

Figure 5-32 Alarm Output

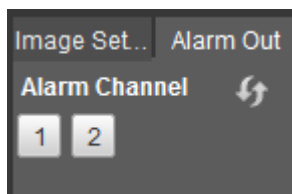

**Step 3** Click the number to select the alarm signal for the corresponding channel.

After the alarm signal is enabled, the icon turns orange like .

 **NOTE**

Click  to refresh the list.

### 5.4.1.6 Multi-channel preview

After the multi-channel preview is enabled, the output image is compressed to combine multiple channels in the local interface to one channel. Then you can view multiple channels from remote access, and save much of the network transmission bandwidth.

Select a channel, and then select the split mode from . Then you can view the multiple channel views in one channel. See Figure 5-33.

Figure 5-33 Multi-channel preview



### 5.4.2 Video playback

On the PLAYBACK interface, you can play back and download recorded video files.

Click **Playback** tab, and the **Playback** interface is displayed. See Figure 5-34.

Figure 5-34 Playback

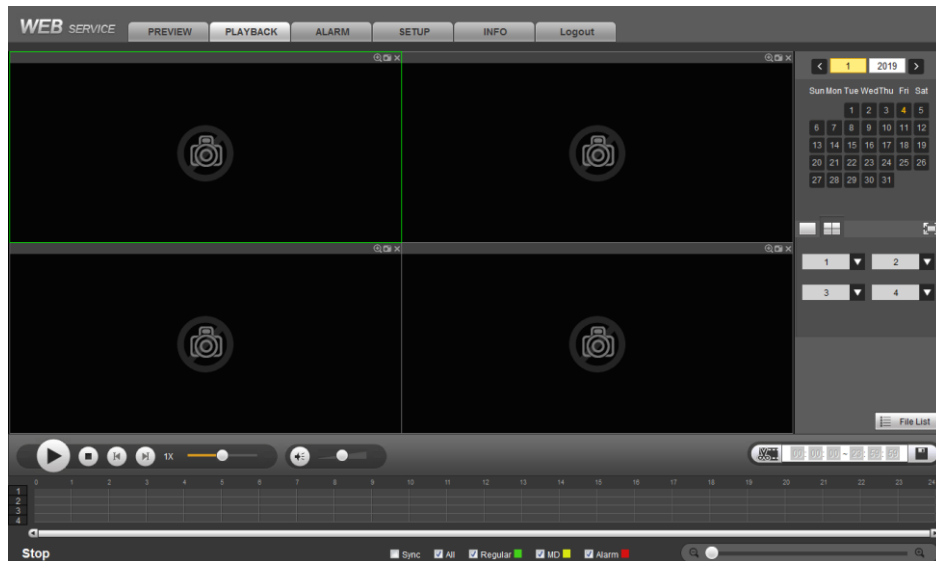







Table 5-16 Function bar description





No.	Function	Description
1	Playback Controls Bar	For detailed information about control buttons, see “5.4.2.1 Playback Controls Bar”
2	Progress Bar	Displays the video type and the time period <ul style="list-style-type: none"> <li>Click any point in the colored area, and the playback starts from this moment</li> <li>Each color matches with a certain video type, see the matching relationship in the video type selection list</li> </ul>
3	Volume adjustment	Controls playback volume, there are two states <ul style="list-style-type: none"> <li>, means mute state</li> <li>, means vocal state, the volume can be adjusted</li> </ul>
4	Sync	If the playback time of other channels is before the time of the selected channel, then other channels will speed up playback till sync with the selected channel. <ul style="list-style-type: none"> <li>If the playback time of other channels is after the time of the selected channel, then other channels will pause to wait till synced with the selected channel</li> <li>If the playback time of other channels is after the time of the selected channel, then other channels will pause to wait till synced with the selected channel</li> </ul>
5	Video type selection	The alarm type includes Regular, MD, and Alarm. Select the alarm type that you want to view
6	Time bar	Move the slider or click  /  to adjust the time bar
7	Select date	Click the date on which you want to play back the recorded video. Yellow indicates current system date; blue indicates there are recorded videos on this date

No.	Function	Description
8	Screen split layout for playback	<ul style="list-style-type: none"> <li>Select the screen split layout and enter the corresponding channel number</li> <li>Click  to display in full screen. Press ESC to exit full screen</li> </ul>
9	File list	You can download recorded video by file type or time, and verify the completeness
10	Video editing	Capture and save certain video section See "5.4.2.3Clipping" for specific steps.

### 5.4.2.1 Playback Controls Bar



See detailed description in Table 5-17.

Table 5-17 Play Control Bar

Icon	Function	Description
	Play	When this icon displays, it means the video is paused or not being played, click this icon to play video
	Stop	Click this icon to stop playback
	Previous frame	Click this icon to jump to the previous frame <b>NOTE</b> You need to pause the playback before using play by frame
	Next frame	Click this icon to play the next frame <b>NOTE</b> You need to pause the playback before using play by frame
	Fast playback and slow playback	Move the slider to adjust the playback speed

### 5.4.2.2 Playing Back Recorded Video Files

You can play back recorded video by time or file type. During playback, the following operations are supported.

- On the channel window, click  then hold down the left mouse button to select the area you want to enlarge. The area is enlarged. Click this icon again or right-click on the window to exit.
- Click  to take a snapshot.
- Click  to close playback.

### 5.4.2.2.1 Playing Back Recorded Video by date

**Step 1** Select the month and year that you want to search, and then select the screen split layout and enter the corresponding channel number.

**Step 2** Select a date with recorded video files, click on the window channel to select a playback channel, and then select the record type.

Figure 5-35 Record Type



**Step 3** Click  to start playing back recorded video.

### 5.4.2.2.2 Playing Back Recorded Video by File List

**Step 1** Select the month and year that you want to search, and then select the screen split layout and enter the corresponding channel number.

**Step 2** Select a date with recorded video files, click on the window channel to select a playback channel.

**Step 3** Click File List.

The recorded videos are displayed in list. See Figure 5-36.

Figure 5-36 File list

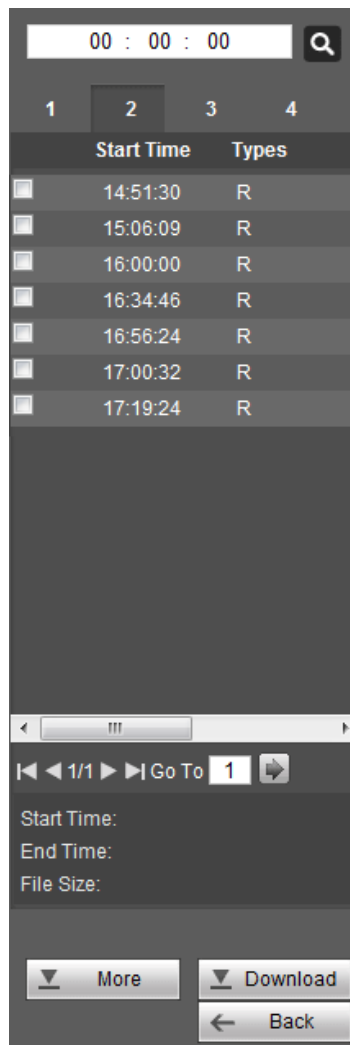



**Step 4** Set up the start time of the queried file list, and then click . The queried recording files are displayed.

**Step 5** Double-click the recorded video file to start playing back recorded video.

 **NOTE**

- Select the video files, and then click **Download**. The recorded files default storage path is C:\RecordDownload. You can modify this path if needed.
- Click **More** to search and download more recorded video files by file type or time. You can also verify whether the watermark is falsified. See "5.4.2.4 Downloading Recorded Files" for specific steps.

### 5.4.2.3 Clipping Recorded Video

You can clip sections of recorded video and save to the PC.

**Step 1** Search the recorded video that you want to clip by using the calendar and time axle.

**Step 2** Select the channel number.

**Step 3** Clip the recorded video by either of the following ways.







- Click , and the  and  sliders appear at the two ends of the time axle. Move the sliders to the proper location, and then click  to clip and save the section between the sliders.
- In the clip box, enter the start time and end time, and then click  to clip and save the section in this period.

Figure 5-37 Clip and save



The system displays the download progress bar. After downloading, the clipped video files are saved in the Record Download folder. You can also change the save path if needed.

 **NOTE**

Click  to stop the video download.

### 5.4.2.4 Downloading Recorded Files

Click **More** and you can search and download the recorded video files by file type or time, and verify whether the file is falsified.

#### 5.4.2.4.1 Download by file

You can download the recorded files by type.

**Step 1** Click the **Download by File** tab.

The **Download by File** interface is displayed. See Figure 5-38.

Figure 5-38 Download by file

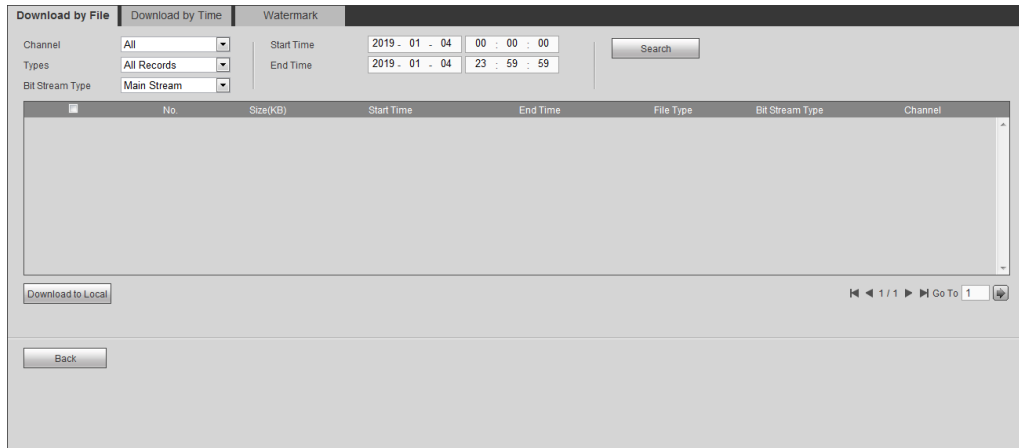

**Step 2** Select channel, type, start time, and end time. Then click **Search**.

The searched files are displayed in the table.

 **NOTE**

The system supports searching the recorded files through the record type (general, motion detect, or alarm), and supports searching the snapshots.

**Step 3** Select the file that you want to download, and then click **Download to Local**.

The **Download to Local** interface is displayed.

**Step 4** Select the record type and save path.

Downloaded video formats supported by the system include DVA and MP4. Choose according to the actual situation.

**Step 5** Click **Save**.

The system indicates the downloading progress and pops up a message after completed.

#### 5.4.2.4.2 Download by time

You can download the recorded video by time.

**Step 1** Click the **Download by Time** tab.

The **Download by Time** interface is displayed. See Figure 5-39.

Figure 5-39 Download by time

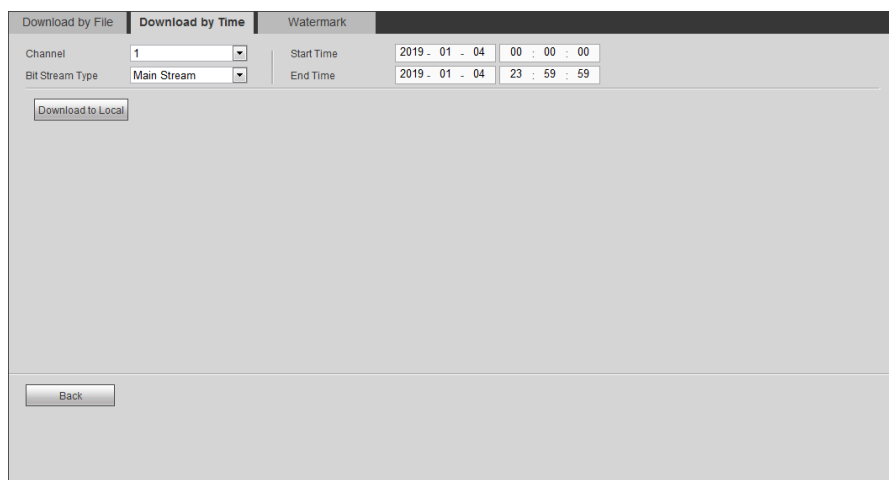

**Step 2** Select channel, bit stream type, start time, and end time.

**Step 3** Click **Download to Local**.

The **Download to Local** interface is displayed..

**Step 4** Select the **Record Format** and **Path**.

Downloaded video formats supported by the system include DVA and MP4. Choose according to the actual situation.

**Step 5** Click **Save**.

The system indicates the downloading progress and pops up a message after completed.

### 5.4.2.4.3 Watermark

You can also verify whether the watermark is falsified.

**Step 1** Click the **Watermark** tab.

The **Watermark** interface is displayed. See Figure 5-40.

Figure 5-40 Watermark

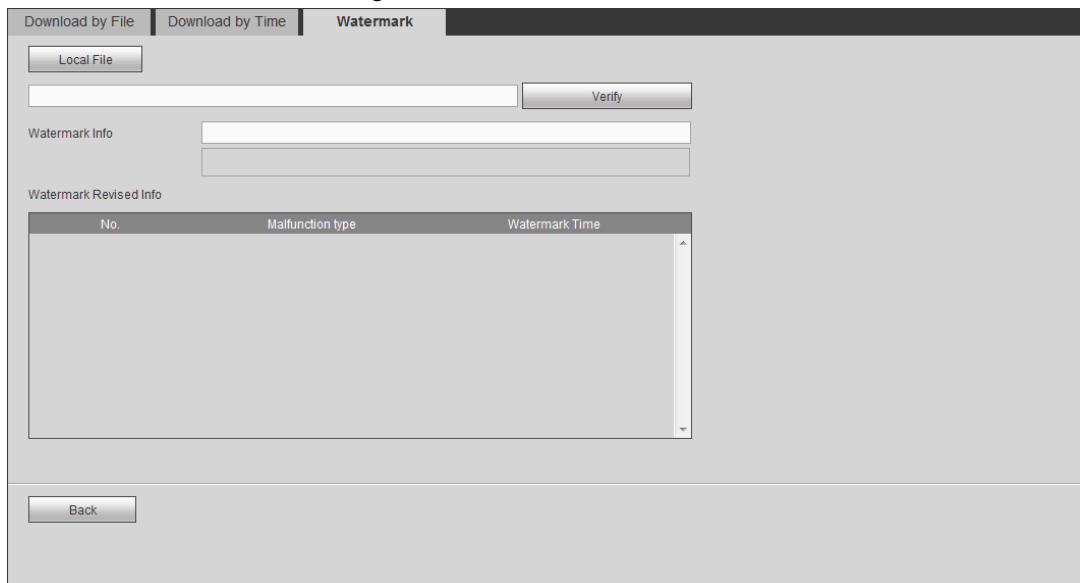

**Step 2** Click **Local File** and select a file that you want to verify.

**Step 3** Click **Verify**.

The system indicates the verifying progress and result after completed. See Figure 5-41.

Figure 5-41 Watermark

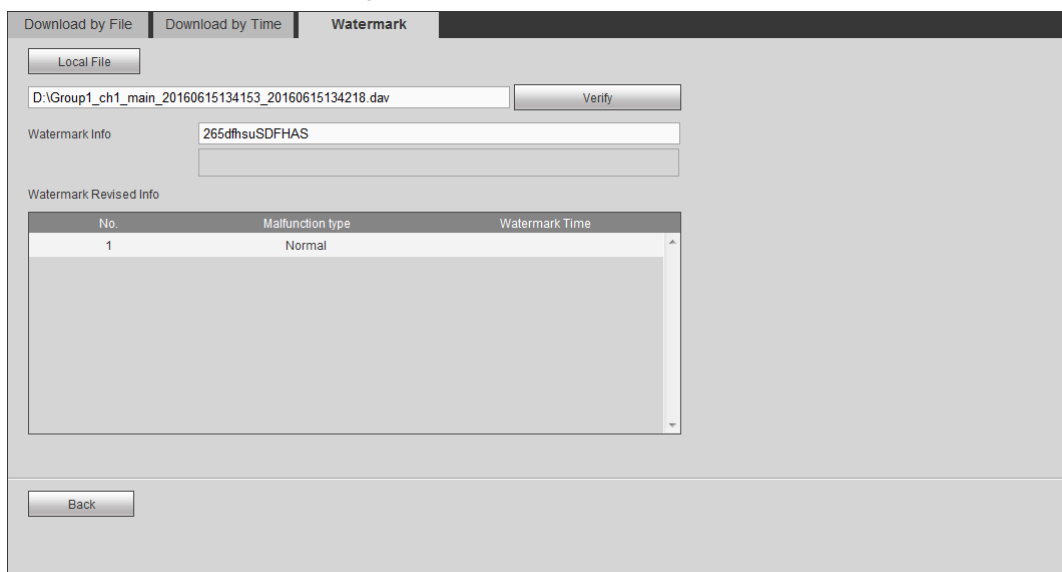

## 5.4.3 Configuring Alarm Events Settings

You can select alarm type as needed, when the selected alarms are triggered, the system would record detailed alarm information at the right side of the interface.

### NOTE

Function of different devices might vary, and the actual product shall prevail.

### 5.4.3.1 Alarm types

For the alarm types and conditions that can trigger the alarm events, see Table 5-18.

Table 5-18 Alarm type description

Alarm type	Description	Preconditions
Motion detection	The alarm is triggered when moving objects are detected	You have enabled motion detection. For detailed operation, see “5.5.3.1.1 Video Detection”
External alarm	The alarm is triggered by the alarm signal that is detected by the alarm input port on the Device	The local alarm function is enabled. For details, see “5.5.3.2 Configuring alarm events settings”
Video tampering	The alarm is triggered when the camera lens is covered	The tampering function is enabled. For details, see “5.5.3.1.2 Configuring Tampering Settings”
Disk error	The alarm is triggered when the HDD has failures or malfunctions	The HDD error detect function is enabled. For details, see “5.5.3.3 Abnormality”
Video loss	The alarm is triggered when video loss occurs	-
Disk full	The alarm is triggered when the free space is less than the set value	The HDD No Space function is enabled. For details, see “5.5.3.3 Abnormality”
Temperature Too High	The alarm is triggered when the Device temperature is too high	The temperature detect function is enabled. For details, see “5.5.3.3 Abnormality”
Low Battery	The alarm is triggered when battery is low	The low battery detection function is enabled. For details, see “5.5.3.3 Abnormality”

### 5.4.3.2 Alarm Event Settings

Enable alarm prompt based on your needs. You can also define alarm sound according to your preference.

**Step 1** Click **Alarm**.

The Alarm interface is displayed, see Figure 5-42.

Figure 5-42 Alarm



**Step 2** Select alarm type.

**Step 3** Select **prompt**, and the system prompts and records alarm information as needed.

- If you are not at the **Alarm** interface when the selected alarm is triggered, there will

be a  displayed on the Alarm tab and the alarm information will be recorded. Click the Alarm tab, and the sign disappears.

- If you are at the **Alarm** interface when the selected alarm is triggered, there will be detailed alarm information displayed at the right side of the interface.

**Step 4** (Optional) Set the alarm sound as needed and the preset alarm sound will be played when an alarm is triggered.

- Select the **Play Alarm Sound**.
- Click **Select** to select the alarm sound file.

## 5.5 System Settings

### NOTE

In this section, when you have configured the settings for a channel, click **Copy** to apply the configurations to other channels. Click **Refresh** to display the latest configuration. Click **Default** to restore to factory default settings.

### 5.5.1 Configuring lens parameter

Configure the image property, encoding parameter, and corresponding channel name of the remote device.

#### 5.5.1.1 Configuring Image Properties

Set up the image property parameters of the channel.

### NOTE

Different cameras correspond to different image parameters. Follow actual parameters.

**Step 1** Select **SETUP > CAMERA > Camera**.

The **Conditions** interface is displayed.

**Step 2** Select a channel.

The **Conditions** interface is displayed. See Figure 5-43.

Figure 5-43 Image settings

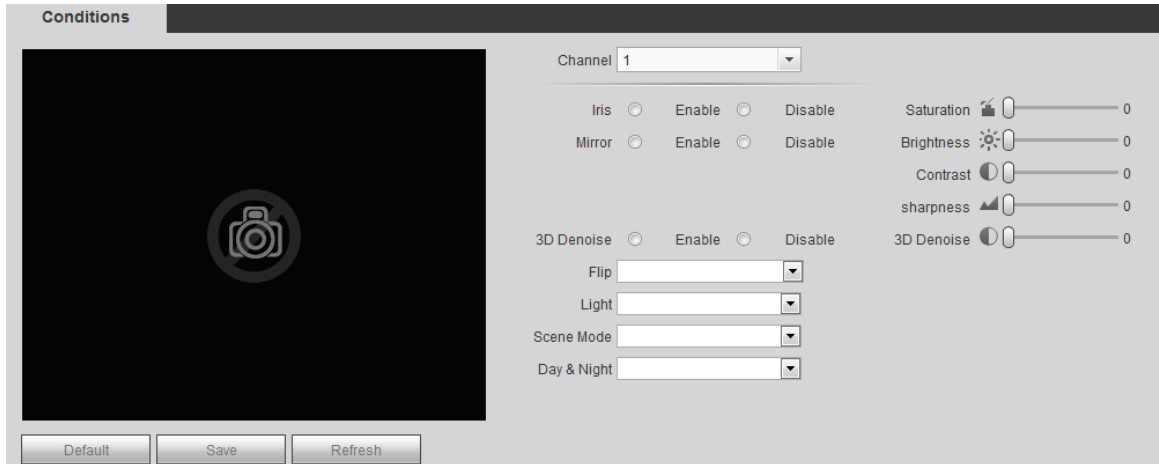

**Step 3** Set up parameters. See Table 5-19. Click **Save**.

Table 5-19 Image setting parameters description

Name	Description
Configuration files	Select the configuration files for the images. You can select Day, Night, Common, and Switch By Period When you select <b>Switch By Period</b> , set up the sunrise time and sunset time
Auto iris	If Enable is selected, the iris size changes automatically according to the ambient lighting, and the image brightness changes accordingly
Mirror	Select <b>Enable</b> and the image will flip left and right.
Saturation	Adjusts the color darkness. Adjust the saturation according to the actual situation. The bigger the value, the lighter the color will become
Brightness	Adjusts the image brightness through linear mode. The bigger the value is, the brighter the image will become
Contrast	Adjusts the contrast of the images. The bigger the value is, the more obvious the contrast between the light area and dark area will become
Sharpness	Adjusts the edge sharpness of images. The bigger the value is, the more obvious the image edge will become
3D NR	Reduces the noises of multiple-frame (at least two frames) images by using inter-frame information between two adjacent frames in a video. If <b>Enable</b> is selected, 3D noise reduction takes effect. Set up the reduction value as needed. The higher the value, the better the noise reduction effect
Auto focus	Select <b>Enable</b> to automatically adjust the image resolution
Flip	Defines how the images flip. Available options include No Flip, 180°, Clockwise 90°, Anticlockwise 90°
Backlight Correction	You can enable backlight correction in backlight scenarios. The system adjusts exposure according to ambient lighting automatically to ensure that images of the darkest area are clearly visible

Name	Description
Scene Mode	<p>In this mode, you can make a white object displaying itself clearly on the video image in all environments. You can select Auto, Sunny Day, Night, and Custom</p> <ul style="list-style-type: none"> <li>• Auto: The system makes color temperature correction according to different light conditions to ensure color precision</li> <li>• Sunny Day: The system makes color temperature correction according to different light conditions to ensure color precision</li> <li>• Night: The system makes color temperature correction according to different road light conditions to ensure color precision</li> <li>• Custom: You can set up the red gains and blue gains manually for the system to correct different color temperatures in the environment accordingly</li> </ul>
Day & Night	<p>You can select device display mode from color or black-and-white mode. You can select Auto, Black-and-White, and Colored</p> <p> <b>NOTE</b>  Day &amp; Night configuration is independent from profile management configuration</p> <ul style="list-style-type: none"> <li>• Colored: The camera displays colored images.</li> <li>• <b>Auto</b>: The system switches between color and black-and-white display according to the actual condition</li> <li>• Black&amp;White: The camera displays black&amp;white images.</li> </ul>

### 5.5.1.2 Configuring encode parameters

Includes setting up video stream, image stream, video overlay, and storage path.

#### 5.5.1.2.1 Configuring Video Streaming

You can configure the encode settings for main stream and sub stream.

Step 1 Select **SETUP > CAMERA > ENCODE > Video Stream**.

The **Video Stream** screen appears. See Figure 5-44.

 **NOTE**

Video stream parameters might be different by device, and the actual product shall prevail.

Figure 5-44 Video Stream

**Step 2** Select a channel.

**Step 3** Configure TCP/IP parameters. For details, see Table 5-20.

Table 5-20 Encode setting parameters description

Name	Description
Stream Type	The stream type is permanently fixed as common and cannot be changed The record types of general, motion detect, and alarm all adopt common bit stream configuration in recording.
Encode Mode	Encode Mode of video
Smart Code	Turning on Smart Code helps compress the images more and reduce the storage space.
Resolution	The higher the video resolution, the better the image quality
Frame Rate (FPS)	Configure the frames per seconds for video. The higher the value, the smoother and more vivid the image
Stream Ctrl	You can select bit rate type <ul style="list-style-type: none"> <li>● CBR: Constant Bit Rate, which changes around the configured value</li> <li>● VBR: Variable Bit Rate, which changes along with environment</li> </ul> <p><b>NOTE</b> It is recommended to select CBR when there might be only small changes in the monitoring environment, and select VBR when there might be big changes in the monitoring environment</p>
Bit Rate	Configure the encode value for main stream and sub stream <ul style="list-style-type: none"> <li>● When CBR is selected, select the bit rate according to the reference bit rate, and the bit rate changes along the configured value</li> <li>● When VBR is selected, select the upper limit value of bit rate according to the reference bit rate, and the bit rate changes along with the monitoring environment. But the maximum bit rate value changes around the configured value</li> <li>● Select <b>Customized</b>, and you can configure bit rate value manually</li> </ul>



Name	Description
Image Quality	This parameter can be set only when <b>Stream Ctrl</b> is set to <b>BRC_VBR</b> . Select the image quality level. The higher the value, the better the image will become
Ref Stream	The system recommends the optimal bit rate range according to the resolution and frame rate settings
Audio Enable	If the Audio Enable check box is selected, the recorded video files are composite audio and video stream
Audio encoding	Select an audio encode format  <b>NOTE</b> The parameters might be different depending on the model you purchased, and the actual product shall prevail
Watermark Enable	Select the <b>Watermark Enable</b> check box to verify whether the recorded video is falsified
Watermark String	Enter the strings for verifying watermark. The default string is DigitalCCTV The watermark string can only consist of number, letter, underline (_), and strikethrough (-), and maximum length contains 127 characters

Step 4 Click **Save**.

#### 5.5.1.2.2 Configuring Snapshot Settings

You can configure the snapshot settings such as snapshot type, image size, quality, and interval.

Step 1 Select **SETUP > CAMERA > ENCODE > Image Stream**.

The **Snapshot Stream** screen appears. See Figure 5-45.

Figure 5-45 Snapshot Stream

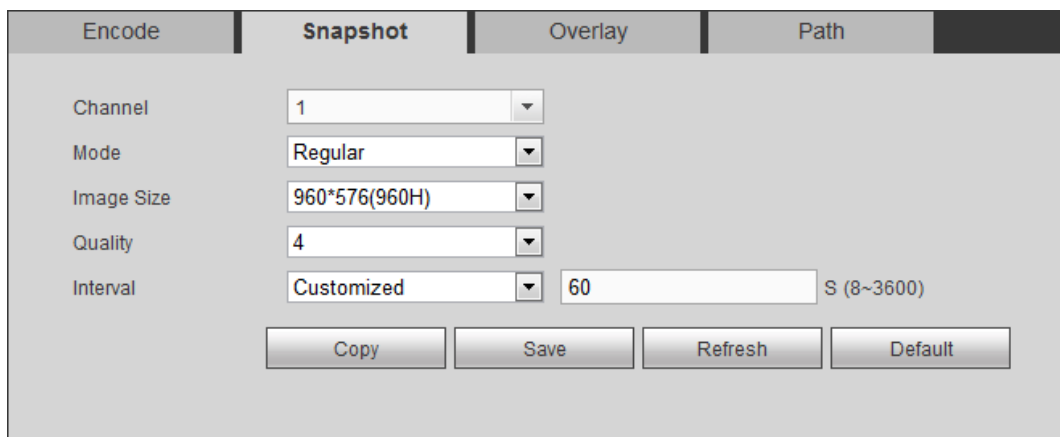

Step 2 Select a channel.

Step 3 Sets up DBHA parameters. See Table 5-21 for details.

Table 5-21 Snapshot setting parameters description

Name	Description
Snap Mode	Includes timing and events <ul style="list-style-type: none"> <li>Timing: Take a snapshot within the configured period</li> <li>Event: Take a snapshot when there is an alarm event triggered, such as for local alarm, video detection and abnormality</li> </ul>

Name	Description
Size	Image resolution of snapshots. It is the same as the resolution of the main stream and cannot be changed
Quality	Configures the image quality by 6 levels
Interval	Interval of taking snapshots Select <b>Customized</b> to configure the snapshot interval for manually capturing snapshots. The maximum value you can set is 3600 seconds as an interval between two snapshots

**Step 4** Click **Save**.

### 5.5.1.2.3 Configuring Video Overlay

You can configure the title of video image overlay.

**Step 1** Select **SETUP > CAMERA > ENCODE > Video Overlay**.

The **Overlay** interface is displayed. See Figure 5-46.

Figure 5-46 Overlay

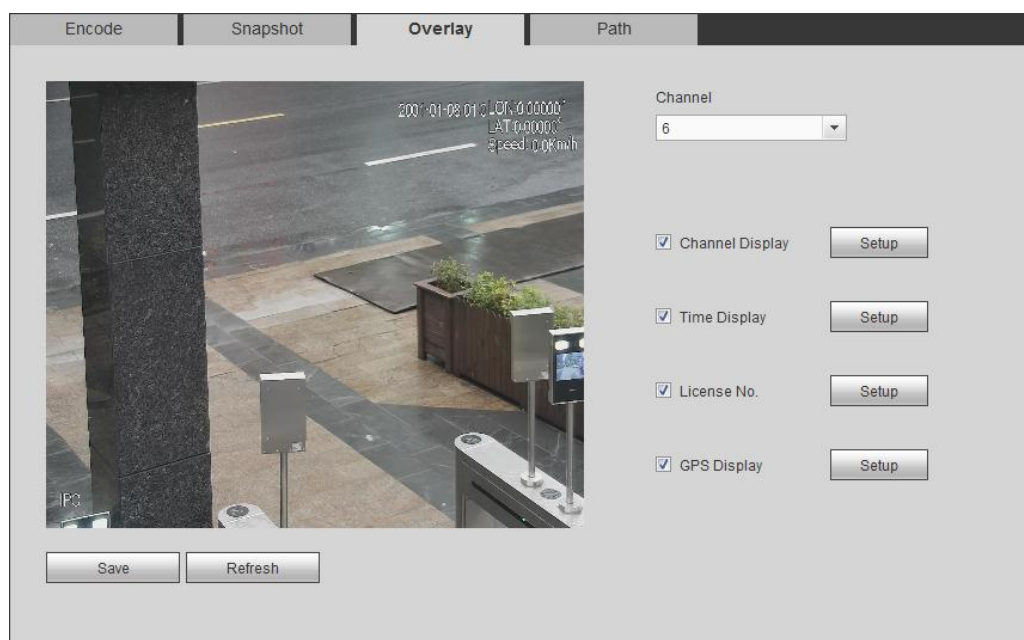

**Step 2** Select a channel.

**Step 3** Sets up DBHA parameters. See Table 5-22 for details.

Table 5-22 Overlay settings parameters description

Name	Description
Period Title	Select the <b>Time Display</b> check box, the <b>Setup</b> button is displayed. Then click <b>Setup</b> , the time is displayed on the channel window, and then drag it to a proper location
Channel Title	Select the <b>Channel Display</b> check box, the <b>Setup</b> button is displayed. Then click <b>Setup</b> , the channel display frame is displayed on the channel window, and then drag it to a proper location
License No.	Select the <b>License No.</b> check box, the <b>Setup</b> button is displayed. Then click <b>Setup</b> , the license number is displayed on the channel window, and then drag it to a proper location

Name	Description
GPS Display	Select the <b>GPS Display</b> check box, the <b>Setup</b> button is displayed. Then click <b>Setup</b> , the GPS display frame is displayed on the channel window, and then drag it to a proper location

Step 4 Click **Save**.

#### 5.5.1.2.4 Path



You can configure the storage path of captured snapshots and recorded videos.

Step 1 Select **SETUP > CAMERA > ENCODE > Storage Path**.

The **Path** interface is displayed, see Figure 5-47.

Figure 5-47 Path

Step 2 Click **Browse** to select the save path for snapshots and records.

On the **PREVIEW** interface, images  and recordings taken by snapshot and recording  are saved in the following paths by default: Default paths:

C:\PictureDownload and C:\RecordDownload

Step 3 Click **Save**.

#### 5.5.1.3 Configuring Channel Name

You can configure the channel name for the corresponding device.

Step 1 Select **SETUP > CAMERA > CHANNEL NAME**.

The **CHANNEL NAME** interface is displayed. See Figure 5-48.

Figure 5-48 Channel Name

Step 2 Configuring Channel Name

Step 3 Click **Save**.

#### 5.5.1.4 Configuring PoE

Review the connection status of the PoE port and reset the camera.

Select **Setup > Camera > PoE**. The **PoE Management** interface is displayed. See Figure 5-49.

Select **PoE Reset**, and click **Apply** to reset the camera with power but offline so that the camera can be online. If the camera is still offline after reset for 3 times, the system will not reset again.

When the total power of the cameras accessed through PoE exceeds the maximum power of the device, the device will force the camera connected to the maximum port number to go offline until the total power of the camera accessed through PoE does not exceed the maximum power of the device.

Figure 5-49 PoE management

Port	Status	Power(W)
1	Offline	0.0
2	Offline	0.0
3	Offline	0.0
4	Offline	0.0
5	Offline	0.0
6	Offline	0.0
7	Offline	0.0
8	Offline	0.0

## 5.5.2 Network Parameters Configuration

Set up the network parameters of the device as needed. This includes setting up the port, Wi-Fi parameters, 3G/4G parameters, Email, FTP, active registration, P2P, and SWITCH.

### 5.5.2.1 Connection Setting

Configure the maximum port numbers and values.

**Step 1** Select **Setup > Network > Connection Setting**.

The **Connection Setting** interface is displayed. See Figure 5-50.

Figure 5-50 Port

**Step 2** Configure the port parameters of the device. For details, see Table 5-23.

**NOTE**

The revised settings take effect after reboot. Proceed with caution.

Table 5-23 Connection setting parameters description

Name	Description
TCP Port	Transmission Control Protocol port, the value is 37777 by default

Name	Description
UDP Port	User Datagram Protocol. The default value setting is 37778. You can enter the value according to your needs
HTTP Port	Hyper Text Transfer Protocol port. The default setting is 80. You can enter the value according to your actual situation, and in this case, add the modified value after the address when logging the Device on the browser
HTTP S Port	Hyper Text Transfer Protocol over Secure Socket Layer port. Select the Enable check box, and then enter the value according to your actual situation. The default setting is 443
RSTP Port	<ul style="list-style-type: none"> <li>Real Time Streaming Protocol port, leave it if the value is 554 by default. If you use Apple browser QuickTime or VLC to play the real-time monitoring screen, the following formats can be used: This function is also available for Blackberry</li> <li>When the URL format requiring RTSP, you need to specify channel number and bit stream type in the URL, and also user name and password if needed</li> <li>When playing live view with Blackberry smart phone, you need to turn off the audio, and then set the code mode to H.264B and resolution to CIF</li> </ul> <p>URL format example  Rtsp://&lt;user name&gt;:&lt;password&gt;@&lt;IP address&gt;:&lt;port&gt;/cam/realmonitor?channel=1&amp;subtype=0</p> <ul style="list-style-type: none"> <li>Username, such as admin</li> <li>Password: For example, admin_123</li> <li>IP address: For example, 192.168.1.16</li> <li>Port: The default setting is 554. If the default setting is displayed, you do not need to configure this parameter</li> <li>Channel: Refers to the Channel number, starting from 1 For example, if it is channel 2, then enter channel=2</li> <li>Subtype refers to Bit stream type; 0 means main stream (Subtype=0) and 1 means sub stream (Subtype=1)</li> </ul> <p>So, if you require the sub stream of channel 2 from a certain device, then the URL should be  rtsp://admin:admin_123@192.168.1.16:554/cam/realmonitor?channel=2&amp;subtype=1</p> <p>If certification is not required, there's no need to specify the username and password. Use the following format  rtsp:// &lt;IP address &gt;: &lt;port&gt;/cam/realmonitor?channel=1&amp;subtype=0</p>

Step 3 Click **Save**.

## 5.5.2.2 Configuring Wireless Network

You can connect the Device to the Internet through Wi-Fi. Make sure the Device can communicate with other devices in the network diagram. The Device itself can also act as a hot spot to share flows with other terminals.

### NOTE

If both 3G/4G and Wi-Fi are available, the Device connects to Wi-Fi and disconnected from 3G/4G.

### 5.5.2.2.1 Configuring Wi-Fi Network

You can connect the Device to network through Wi-Fi. Then connect the PC to the same network. You can login to the web interface using the PC and operate the Device.

#### NOTE

This function is supported on the Device with the Wi-Fi module only. Follow on-device information.

## Preconditions

Make sure the Device is connected to a Wi-Fi module.

## Steps

**Step 1** Select **Setup > Network > WIFI**.

The WIFI interface is displayed.

**Step 2** Select Wifi as the working mode.

The WIFI configuration interface is displayed. See Figure 5-51.

Figure 5-51 Wi-Fi

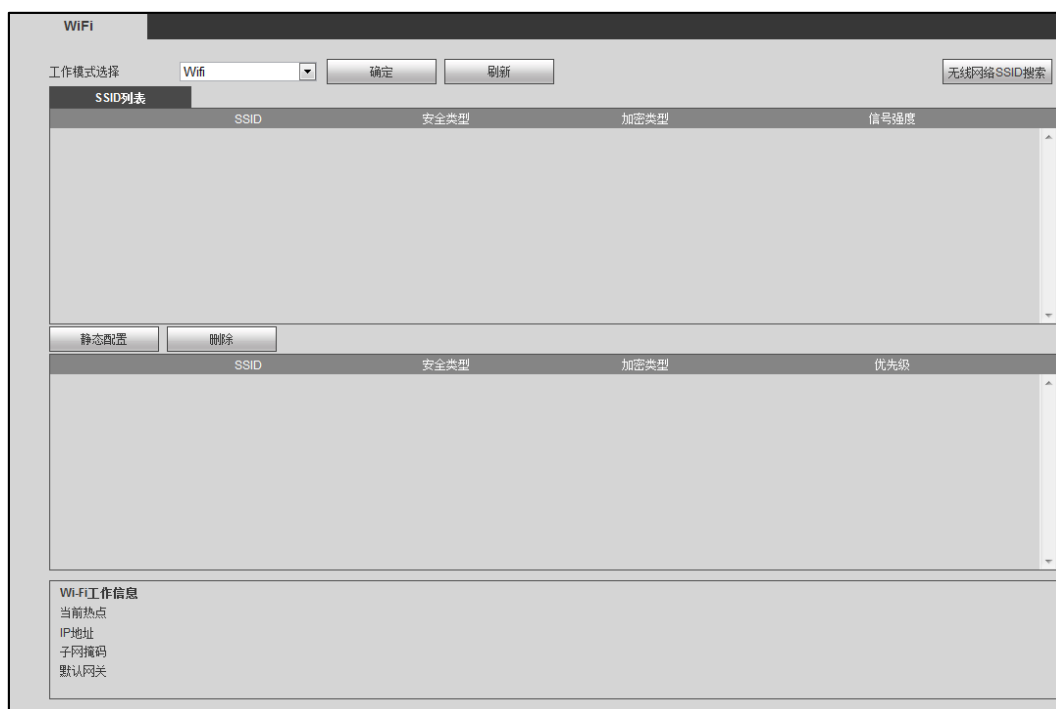

**Step 3** Connect to Wi-Fi.

- Auto search
  1. Click Search SSID.

In the SSID list, all the available Wi-Fi networks are listed, including the information such as network name, connect mode, authorize mode, and signal intensity.
  2. Double-click the Wi-Fi you want to connect, enter the password, and then click Save.
- Add Wi-Fi manually.
  1. Click **Static Setting**.

The **WIFI** interface is displayed. See Figure 5-52.

Figure 5-52 WIFI

The screenshot shows a 'WIFI' configuration window with the following fields and values:

- SSID: [Empty text box]
- Connection Status: No Connection
- Priority: 1 (dropdown menu)
- Verification: WPA2-PSK (dropdown menu)
- Encrypt Type: AES (dropdown menu)
- Input Password: [Empty text box]
- IP Address: 0 . 0 . 0 . 0 (with a checked  DHCP checkbox)
- Subnet Mask: 0 . 0 . 0 . 0
- Default Gateway: 0 . 0 . 0 . 0

Buttons: Save, Cancel

2. Enter SSID and password, select priority level and verification type, set IP address, subnet mask, and gateway.  
If you select the DHCP check box, after successful connection, the system automatically obtains the IP address, subnet mask, and gateway.
3. Click **Save**.

Step 4 Click **Save**.

Click **Refresh** to refresh the connection status.

After successful connection, you can view the current hotspot, IP address, subnet mask, and gateway in **WIFI Working Info**.

#### 5.5.2.2.2 Configuring Wi-Fi Hotspot

The Device can work as a hotspot to share the network connection to other terminals. The terminals connected to the hotspot can login to the Device through IP address (192.168.2.108). After login, you can preview videos on the Device.

Step 1 Select **Setup > Network > WIFI**.

The WIFI interface is displayed.

Step 2 Select **Ap** as the working mode.

The Ap Configuration interface is displayed. See Figure 5-53.

Figure 5-53 Ap configurations

**Step 3** Enter SSID information, select work band and verification type, and then enter the connection password.

- The work band can only be 2.4G.
- Select the Connection Password check box, the clear text password is displayed. The default password is 12345678.

**Step 4** Click **Save**.

### 5.5.2.3 Configuring 3G/4G Settings

#### Preconditions

- Make sure the Device is equipped with 3G/4G module and inserted with SIM card from the Communication Operator.
- The dial number, user name, and password have been obtained from the Communication Operator.

#### Steps

**Step 1** Select **Setup > Network > 3G**.

The **CDMA/GPRS Setup** interface is displayed.

 **NOTE**

After 3G/4G module is connected, the module information and wireless signal are displayed; if not, click **Search** to search for wireless signal.

**Step 2** Select **3G Network** and **Enable** to open the network. This function is enabled by default.

**Step 3** Configure TCP/IP parameters. For details, see Table 5-24.

Table 5-24 3G/4G setting parameters description

Name	Description
NetAccess	When the Device is accessed to private network, select the <b>NetAccess</b> check box, enter APN name and select authentication mode. If <b>PAP</b> or <b>CHAP</b> is selected for authentication mode, enter user name and password, then the Device is automatically accessed to private network



Name	Description
Wireless Network Type	When enabled, the network type is displayed, which is used to distinguish the 3G/4G modules among Communication Operators, such as TD-LTE
APN	Displays access point of Communication Operator. To manually set up APN, select <b>Customized</b>
AUTH	Includes PAP, CHAP, and NO_AUTH protocols. The system automatically recognizes and displays the enabled protocol
Dial Number	Enter the dial number provided from the Communication Operator
Username	This parameter needs to be set up when the authentication mode is PAP or CHAP The system automatically recognizes the username and password
Password	
Wireless network status	After successful dial-up, all relevant information is displayed without any setup needed. Such information includes module status, SIM status, dial-up status, working mode, IMSI, IMEI, IP address, subnet mask, gateway, and module number
Wireless Signal	Click <b>Search</b> to search for wireless signals

Step 4 Click **Save**.

After access is succeeded, the obtained IP address is displayed.

### 5.5.2.4 Configuring Email Settings

You can configure the email settings to enable the system to send the email as a notification when there is an alarm event occurs, such as video detection and system events.

Step 1 Select **SETUP > NETWORK > EMAIL**.

The **EMAIL** interface is displayed. See Figure 5-54.

Figure 5-54 Email



The screenshot shows the 'Email' configuration page. At the top, there is a tab labeled 'Email'. Below it, there is a section with a checkbox labeled 'Enable' which is currently unchecked. Underneath, there are several input fields: 'SMTP Server' with the value 'MailServer', 'Port' with the value '25' and a range '(0~65500)', 'Username', 'Password', and 'Sender', all of which are empty. Below these is a section for 'Encrypt Type' with a dropdown menu set to 'TLS'. The 'Subject' field contains 'MXVR ALERT'. The 'Receiver' field is empty and has '+' and '-' buttons next to it. Below that, there is an 'Interval' field with the value '120' and the unit 'sec. (0~3600)'. There is also a 'Health Enable' checkbox which is unchecked, with a '60' min. (30~1440) field next to it. At the bottom, there are four buttons: 'Email Test', 'Save', 'Refresh', and 'Default'.

**Step 2** Select **Enable** to enable email.

**Step 3** Configure TCP/IP parameters. For details, see Table 5-25.

Table 5-25 Email setting parameters description

Name	Description
SMTP Server	Configure the address of SMTP (Simple Mail Transfer Protocol) server.
Port	Enter the port value of SMTP server.
Username	Enter the user name and password of SMTP server.
Password	
Sender	Sender's email address
Encryption type	In the Encrypt list, select an encryption type from NONE, SSL, and TLS.
Title	You can enter no more than 63 characters in Chinese, English, and Arabic numerals
Attachment	Select <b>Attachment</b> . When an alarm takes place, the system can send alarm linkage and take snapshots
Receiver	Receiver's mail address You can enter up to three email addresses separated by colons

Name	Description
Interval	<p>This is the interval that the system sends an email for the same type of alarm event, which means, the system does not send an email upon any alarm event</p> <p>The interval ranges from 0 to 3600 seconds. 0 means that there is no interval</p> <p> <b>NOTE</b></p> <p>This setting helps to avoid the large amount of emails caused by frequent alarm events</p>
Health Enable	<p>The system sends test mail to check if the connection is successfully set up</p> <p>Select the <b>Health Enable</b> check box, and then enter the interval. The system can send a test email to check the connection after the specified interval</p> <p> <b>NOTE</b></p> <p>The value ranges from 30 minutes to 1440 minutes</p>
Email Test	<p>Click <b>Email Test</b> to test if emails can be sent out and received as intended. If the configuration is correct, you would receive test email.</p> <p>Before testing, click <b>Save</b> to save the email settings</p>

Step 4 Click **Save**.

## 5.5.2.5 Configuring FTP Settings

Back up recorded videos and images to the preset FTP (File Transfer Protocol) server for storage.

### Preconditions

Make sure you have purchased or download a FTP server and installed it on your PC.

 **NOTE**

For the created FTP user, you need to set the write permission; otherwise the upload of recorded videos and snapshots will be failed.

### Steps

Step 1 Select **Setup > Network > FTP**.

The **FTP** interface is displayed. See Figure 5-55.

Figure 5-55 FTP setting

**Step 2** Select **Enable** to enable FTP upload.

**Step 3** The system selects **SFTP** by default. It is recommended to keep this default setting.

When selecting **FTP**, the system gives a risk prompt. Select **Save** or **Cancel** based on your needs.

**Step 4** Configure TCP/IP parameters. For details, see Table 5-26.

Table 5-26 FTP parameter description

Name	Description
Server IP	The IP address of the PC that is installed with the FTP/SFTP server
Port	The default value is 21
Username	The username and password used to access the server
Password	
Anonymous	Select <b>Anonymous</b> if you want to login to the server anonymously
Remote Directory	<p>Create folder on FTP server</p> <ul style="list-style-type: none"> <li>If you do not enter the name of remote directory, the system automatically creates the folders according to the IP, time, and channel</li> <li>If you enter the name of remote directory, the system creates the folder with the entered name under the FTP/SFTP root directory first, and then automatically creates the folders according to the IP, time, and channel</li> </ul>

Name	Description
File Length	<p>Enter the length of the uploaded recorded video</p> <ul style="list-style-type: none"> <li>• If the entered length is less than the recorded video length, only a section of the recorded video can be uploaded</li> <li>• If the entered length is more than the recorded video length, the whole recorded video can be uploaded</li> <li>• If the entered length is 0, the whole recorded video will be uploaded</li> </ul>
Image Upload Interval	<ul style="list-style-type: none"> <li>• When the <b>Snap Mode</b> is <b>Regular</b>, the image upload method should be determined according to the upload interval and snapshot interval. <ul style="list-style-type: none"> <li>◇ If this interval is longer than snapshot interval, the system uploads the most recent snapshot. For example, if the upload interval is 5 seconds, and snapshot interval is 2 seconds per snapshot, then an upload command is issued every 5 seconds to upload the following picture captured.</li> <li>◇ If this interval is shorter than snapshot interval, the system uploads the snapshot per the snapshot interval. For example, if the interval is 5 seconds, and snapshot interval is 10 seconds per snapshot, the system uploads the snapshot every 10 seconds</li> </ul> </li> <li>• When the <b>Snap Mode</b> is <b>Event</b>, the system uploads captured pictures according to snapshot interval.</li> </ul> <p> <b>NOTE</b>  You can configure the <b>Snap Interval</b> and <b>Snap Mode</b>. For details, see “5.5.1.2.2Configuring Snapshot Settings”.</p>
Channel	Select the channel that you want to apply the FTP settings
Weekday	Select the week day and set the time period that you want to upload the recorded files. You can set two periods for each week
Time Period	Select the record type (Alarm, MD, and General) that you want to upload. After checking the corresponding recording type next to the corresponding period, the selected recording type will be uploaded during the configured period

**Step 5** Click **Test** to test if the FTP/SFTP server is successfully configured.

- The system pops up a message to indicate success or failure.
- If failed, check the network connection or configurations.

**Step 6** Click **Save**.

### 5.5.2.6 Setting up auto registration

After successfully auto registered, when the device is connected into the Internet, it will report the current location to the specified server to make it easier for the Client software to access the Device, and to preview and monitor it.

**Step 1** Select **Setup > Network > Register**.

The Auto Registration interface is displayed. See Figure 5-56.

Figure 5-56 Auto Registration

**Step 2** Select the Enable check box .(Selected by default)

**Step 3** Configure TCP/IP parameters. For details, see Table 5-27.

Table 5-27 Auto Registration descriptions

Name	Description
Server IP	In the Server IP box, enter the IP address or domain name of the server to register
Port	The port for auto-registration
Sub-device ID	Unique ID for identifying the device. When different devices register to the same server, the sub-device IDs should be different

**Step 4** Click **Save**.

### 5.5.2.7 Configuring P2P Settings

P2P is a private network penetration technology. With this technology, you do not need to apply for dynamic domain name, set port mapping, or deploy transit server. You can add devices for management by either of the following two ways.

- Download an app to your mobile phone by scanning the QR code on the interface by using mobile phone client, and sign up an account, see “Client Operation Examples.”
- Login [www.gotop2p.com](http://www.gotop2p.com) platform to register, and then add devices by device serial number. For details, see P2P Operation Manual.



**Before using P2P, make sure the device is connected to the Internet.**

#### Preconditions

- The device is connected to the Internet.
- DMSS Client is downloaded and installed on you mobile phone.

#### Steps

**Step 1** Select **SETUP > NETWORK > P2P**.

The P2P interface is displayed, see Figure 5-57.

Figure 5-57 P2P



Step 2 Select **Enable** to enable P2P.

Step 3 Use DMSS Client to scan the QR code under Device SN to add the device to DMSS Client.



Scan the QR code on the actual interface of Device.

Step 4 Click **Save**.

After configuration is complete, the Status box shows **Online**, meaning the P2P registration is successful.

## Adding Device into Mobile Phone Client

To use this function, take adding device into mobile phone client as an example.

Step 1 On your mobile phone, download the application.

Step 2 After the installation, run the client, select **Remote Monitoring** and go to the main menu.

Step 3 Add the device to the mobile client.



- 3) Click  and then select Device Manager.  
The **Device Manager** interface is displayed. See Figure 5-58.

Figure 5-58 Device management

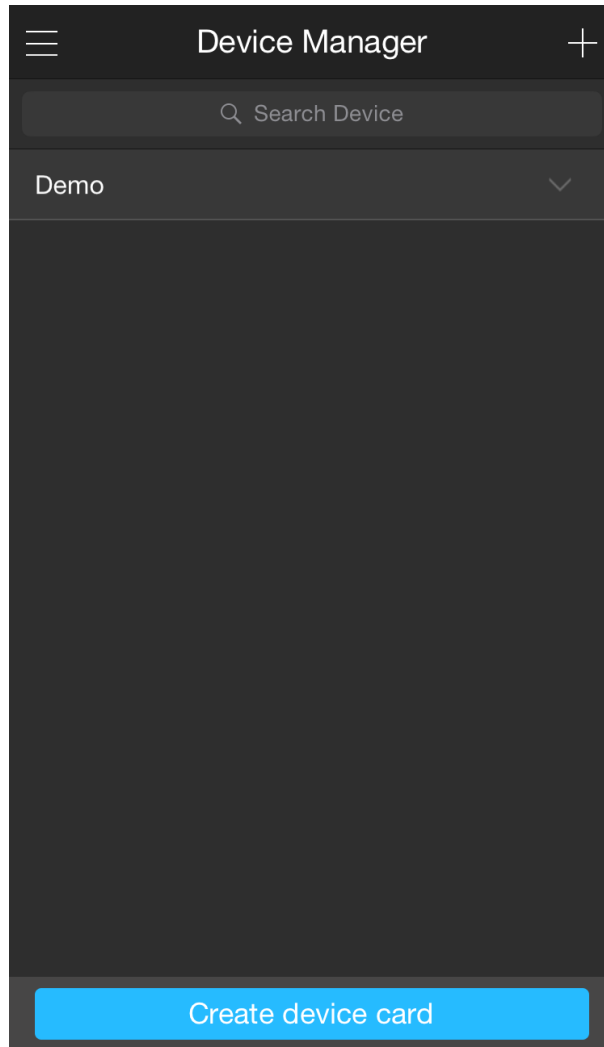

- 4) Click , initialize the device as needed and follow on-screen instructions to connect the device. To do so, you can scan the device label or the serial number QR code of the device on the device page.  
After scanning, the device is added. The serial number of the device is displayed in **Serial Number** section.

Step 4 To review the monitoring image of the device, click **Start Preview**.

## 5.5.3 Set alarm information

You can configure the alarm settings such as video detection, alarm events, abnormality, and alarm output.

### 5.5.3.1 Configuring Video Detection Settings

Video detection includes motion detect and tampering. This function detects abnormal video images.



### 5.5.3.1.1 Video Detection

When the moving object appears and moves fast enough to achieve the preset sensitivity value, the system triggers an alarm and alarm linkage.

**Step 1** Select **Setup > Event Handling > Video Detection > Motion Detect**.

The Motion detection interface is displayed, see Figure 5-59.

Figure 5-59 Motion detection

The screenshot shows the 'Motion Detect' configuration window. It has a 'Tampering' tab selected. The interface includes several settings: 'Enable' (checked), 'Anti-dither' (input field), 'Sensitivity' (dropdown set to 1), 'Region' (Setup button), 'Delay Motion' (checkbox), 'Record Channel' (Setup button), 'Delay' (input field), 'Alarm Out' (input fields 1 and 2), 'Latch' (input field), 'Snapshot' (Setup button), 'Show Message' (checkbox), 'Send Email' (checkbox), 'Buzzer' (checkbox), and 'Log' (checkbox). 'Save' and 'Refresh' buttons are at the bottom.

**Step 2** Select **Enable** and select target channels for dynamic detection.

**Step 3** Region configuration

1) Click **Setup** after Region

The **Setup** interface pops up. See Figure 5-60.

Figure 5-60 Motion detect region setup

The screenshot shows the 'Setup' dialog box for region configuration. It features a video feed with a red grid overlay. On the right, there are controls for 'Region' (color selection), 'Zone Name' (input field with 'Region1'), 'Sensitivity' (slider at 92), and 'Threshold' (slider at 5). 'Save' and 'Cancel' buttons are at the bottom right. 'Clear' and 'Delete' buttons are at the bottom left. Metadata like '2007-01-03 01:24:00' and 'Speed: 0.0 km/h' is visible on the video feed.

2) Select a region and set up the region name.

The higher the sensitivity value is, the easier the motion detection is triggered; the lower the threshold is, the easier the motion detection is triggered. By default, the entire video images are covered by dynamic detection.

 **NOTE**

Each color represents a certain region, you can set different motion detection areas for each region.

- 3) Drag the left button of the mouse, and select the area of the image to be detected, and set up its sensitivity and threshold value.



 **NOTE**

Channel alarm events: As long as any one of the four regions triggers alarm, the channel that houses the region will give alarm.

- 4) Click **Save** to finish configuration.

Step 4 Sets up DBHA parameters. See Table 5-28 for details.

Table 5-28 Motion detect parameter description

Name	Description
Anti-dither	The system records only one event during this period
Sensitivity	Sensitivity for detecting alarm events
Delay Motion	Select the <b>Delay Motion</b> check box, and then the system detects motion events after the delay time
Record Channel	Select the <b>Record Channel</b> check box and select a record channel(s), when an alarm event occurs, the corresponding channel starts recording automatically  <b>NOTE</b> Two more conditions must be satisfied before alarm recording function works: <ul style="list-style-type: none"> <li>• Motion detection recording is enabled. See 5.3.5.1Configuring Recording Schedule</li> <li>• Auto recording is enabled. See 5.3.4Configuring Record Settings</li> </ul>
Recording delay	After an alarm finishes, the alarm recording is extended for a period of time and stops.
Alarm Output	Connect the alarm device such as light and siren to the alarm output port. Select the check box of Alarm Outto enable the alarm linkage. When an alarm event occurs, the system links the alarm device to activate alarm
Latch	Set a length of time during which the device continues alarm output after the alarm ends
Snapshot	Select the Snapshot check box and select a snapshot channel(s).When an alarm event occurs, the corresponding channel starts capturing automatically  <b>NOTE</b> You can also configure the frequency, size, and quality of snapshot. For details, see “5.5.1.2.2Configuring Snapshot Settings”
Show Message	Select the Show Message check box to enable a pop-up message in your local host PC when an alarm event occurs
Buzzer	Select the Buzzer check box to activate a buzzer noise at the device when an alarm event occurs

Name	Description
Send Email	Select <b>Send email</b> , and when alarm is triggered, the system sends email to the specified mailbox  <b>NOTE</b> Set your e-mail first before enabling this function. See 5.5.2.4 Configuring Email Settings for detailed operations
System log	Select the System Log check box to enable the device to record a local alarm log when an alarm event occurs

Step 5 Click **Save**.

### 5.5.3.1.2 Configuring Tampering Settings

When the camera lens is covered, or the video is displayed in a single color because of the causes such as sunlight status, the monitoring cannot be continued normally, and in this case, the system activates alarm and links the configured actions.

Step 1 Select **SETUP > EVENT HANDLING > VIDEO DETECTION > TAMPERING**.

The **Tampering** interface is displayed. See Figure 5-61.

Figure 5-61 Video tampering

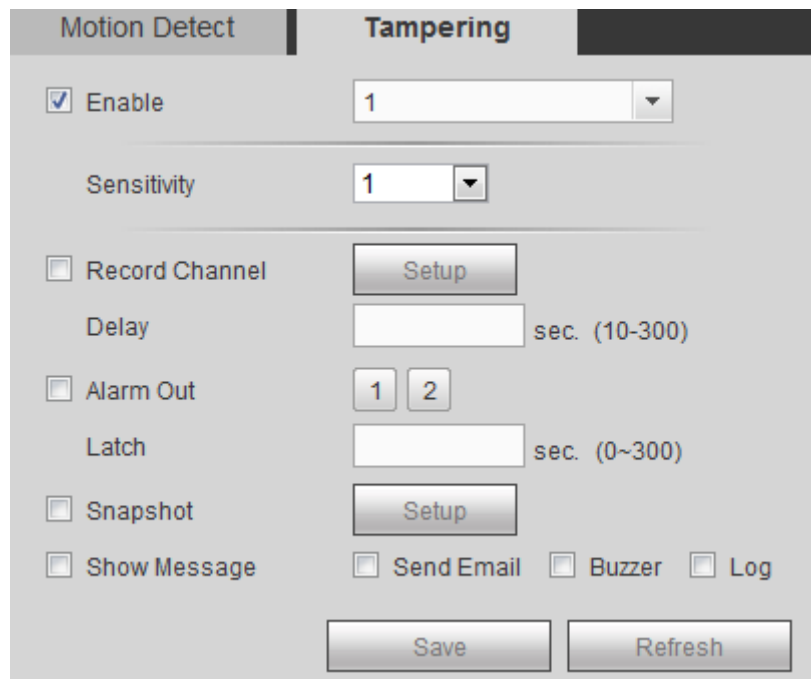

Step 2 Select **Enable Channel** and the target channel for video tampering detection.

Step 3 Sets up DBHA parameters. See Table 5-28 for details.

Step 4 Click **Save**.

### 5.5.3.2 Configuring alarm events settings

Select different types of input according to different source of alarms and set up alarm output manners.

Step 1 Select **SETUP > EVENT HANDLING > ALARM > LOCAL ALARM**.

The **LOCAL ALARM** interface is displayed. See Figure 5-62.

Figure 5-62 Alarm settings

**Step 2** Click Local Alarm or IPC Disconnect tab respectively based on your needs.



- Local Alarm: The alarm signal detected by the alarm input port on the Device.
- IPC Disconnect: The alarm signal is generated when the IP camera is disconnected.

**Step 3** Select the **Enable** check box and the target alarming channel number.

**Step 4** Sets up DBHA parameters. See Table 5-29 for details.

Table 5-29 Parameter description of relay-out

Name	Description
Alarm Name	Enter a customized alarm name
Overlay	Select the <b>Overlay</b> check box to overlay alarm names onto channel images
Anti-dither	The system records only one alarm event during this period
Device type	If selecting <b>Local Alarm</b> as the <b>Event Type</b> , configure this parameter <ul style="list-style-type: none"> <li>• Normal Open: The alarm signal is disconnected normally. The alarm is activated when alarm signal is connected</li> <li>• Normal Close: The alarm signal is disconnected normally. The alarm is canceled when alarm signal is disconnected</li> </ul>
Trigger	If selecting <b>Local Alarm</b> as the <b>Event Type</b> , configure this parameter If the alarm signal is 12V/24V voltage, select <b>High</b> as the triggering mode; if the alarm signal is ground voltage, select <b>Low</b> as the triggering mode
Record Channel	Select the <b>Record Channel</b> check box and select a record channel(s), when an alarm event occurs, the corresponding channel starts recording automatically <b>NOTE</b> Two more conditions must be satisfied before alarm recording function works: <ul style="list-style-type: none"> <li>• Alarm recording is enabled. See 5.3.5.1Configuring Recording Schedule</li> <li>• Auto recording is enabled. See 5.3.4Configuring Record Settings</li> </ul>
Recording delay	After an alarm finishes, the alarm recording is extended for a period of time and stops.

Name	Description
Alarm Output	Connect the alarm device such as light and siren to the alarm output port. Select the check box of Alarm Out to enable the alarm linkage. When an alarm event occurs, the system links the alarm device to activate alarm
Latch	Set a length of time during which the device continues alarm output after the alarm ends
Tour	Select the Tour check box and the channels. When an alarm event occurs, a tour of the selected channels is displayed on the Device local interface  <b>NOTE</b> After tour is completed, the live view screen returns to the window split mode before tour.
Snapshot	Select the Snapshot check box and select a snapshot channel(s).When an alarm event occurs, the corresponding channel starts capturing automatically  <b>NOTE</b> You can also configure the frequency, size, and quality of snapshot. For details, see “5.5.1.2.2Configuring Snapshot Settings”
Show Message	Select the Show Message check box to enable a pop-up message in your local host PC when an alarm event occurs
Buzzer	Select the Buzzer check box to activate a buzzer noise at the device when an alarm event occurs
Send Email	Select <b>Send email</b> , and when alarm is triggered, the system sends email to the specified mailbox  <b>NOTE</b> Set your e-mail first before enabling this function. See 5.5.2.4 Configuring Email Settings for detailed operations
System log	Select the System Log check box to enable the device to record a local alarm log when an alarm event occurs

Step 5 Click **Save**.

### 5.5.3.3 Abnormality

Configure the ways to handle the device when errors occur.

Step 1 Select **SETUP > EVENT HANDLING > ABNORMALITY HANDLING**.

The **HardDisk** interface is displayed. See Figure 5-63.

Figure 5-63 Abnormality

**Step 2** Select **Enable** to enable the handling of corresponding abnormal events.

**Step 3** Sets up DBHA parameters. See Table 5-30 for details.

Table 5-30 Abnormal event setting parameters description

Name	Description
Event type	<p>You can configure the corresponding abnormal events on following three tabs</p> <ul style="list-style-type: none"> <li>• HardDisk: Includes No HDD, HDD Error, HDD No Space</li> <li>• User: Includes illegal login</li> <li>• Device: Includes Temperature Too High, Low Battery, Over Speed, Low Speed, Collision, and Rollover</li> </ul> <p> <b>NOTE</b> The event type might be different depending on the model you purchased, and the actual interface shall prevail</p>
Attempt(s)	<p>If <b>Illegal Login</b> is selected, configure this parameter. In the Attempt(s) box, enter the maximum number of allowed password input errors. If the number of password input errors reaches this value, the user account will be locked.</p>
Lock Time	<p>If <b>Illegal Login</b> is selected, configure this parameter. Set up the lock time for the locked user account when the number of password input errors reaches this value.</p>
Ceiling temperature	<p>If <b>Temperature Too High</b> is selected, configure this parameter. Enter the upper limit of device temperature. The alarm is triggered when the device temperature exceeds this value.</p>
Less Than	<p>If <b>Battery Low Voltage</b> is selected, configure this parameter.</p>
Accumulator voltage	<p>In the Battery Voltage boxes, enter the minimum percentage of supply voltage and supply voltage to the device from the vehicle. When the vehicle is in ACC Off, the voltage supplied to the device is lower than the preset minimum percentage, the system generates an alarm.</p>

Name	Description
Max Speed	If Over Speed is selected, configure this parameter The upper limit of vehicle speed. When the vehicle speed exceeds this value, the system generates an alarm
Min Speed	If Low Speed is selected, configure this parameter The lower limit of vehicle speed. When the vehicle speed is lower than this value, the system generates an alarm
Alarm Output	Connect the alarm device such as light and siren to the alarm output port. Select the check box of Alarm Out to enable the alarm linkage. When an alarm event occurs, the system links the alarm device to activate alarm
Latch	Set a length of time during which the device continues alarm output after the alarm ends
Show Message	Select the Show Message check box to enable a pop-up message in your local host PC when an alarm event occurs
Send Email	Select <b>Send email</b> , and when alarm is triggered, the system sends email to the specified mailbox  <b>NOTE</b> Set your e-mail first before enabling this function. See 5.5.2.4 Configuring Email Settings for detailed operations
Buzzer	Select the Buzzer check box to activate a buzzer noise at the device when an alarm event occurs
System log	Select the System Log check box to enable the device to record a local alarm log when an alarm event occurs
Auto reboot	Select the Auto Reboot check box. If No HDD alarm occurs, the system restarts within three minutes

Step 4 Click **Save**.

### 5.5.3.4 Configuring Alarm Output Settings

Configuring Alarm Output Mode

Step 1 Select **Setup > Event Handling > Alarm Output**.

The **Alarm Out** interface is displayed. See Figure 5-64.

Figure 5-64 Alarm Output



**Alarm Out**

Alarm Type      All    1    2

Auto                   

Manual                 

Stop                   

STATUS              

Save              Refresh

**Step 2** Select alarm output mode.

- Manual: After the alarm linkage is configured, no matter whether there is an alarm event occurs, the corresponding alarm output port keeps generating alarm.
- Auto: After the alarm linkage is configured, when an alarm event occurs, the corresponding alarm output port generates alarm.
- Stop: After the alarm linkage is configured, no matter whether there is an alarm event occurs, the corresponding alarm output port never generate alarm.

**Step 3** Click **Save**.

Status: Indicates the status of each alarm output port.  Indicates there is an alarm output, and  indicates there is not.

## 5.5.4 Managing storage device

Configure HDD storage, package basic information, manage HDD, and review HDD information.

### 5.5.4.1 HDD Management

Set up the read/write properties of HDD and review HDD capacity.

Select **Setup > Storage Management > HDD Management**. The **HDD Management** interface is displayed. See Figure 5-65.

You can set up the HDD as the read/write disk and redundancy HDD on the HDD Operation column.

- Read/Write: Read HDD data and save data to HDD.
- Redundancy HDD: If more than two HDDs are connected to the device or SD card, one HDD can be set to the redundancy HDD for recording backup.

Select the HDD and click **Formatting** to clear all data from the HDD. Proceed with caution.

Figure 5-65 Storage Device

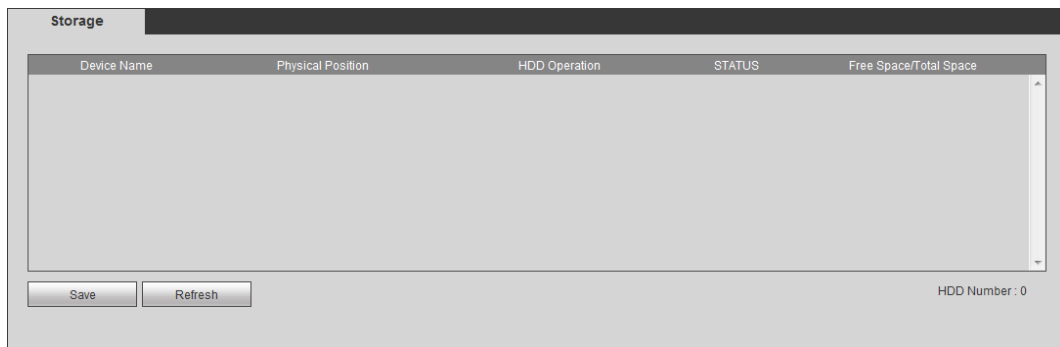

### 5.5.4.2 Viewing HDD Information

You can view the HDD information, time period of recording files, and Smart information.

Select **INFO > INFO > HDD**. The **HDD** interface is displayed. See Figure 5-66.

- Double-click the HDD. The **SMART** interface is displayed. See Figure 5-67. On this interface, you can find the name, model, serial number, healthy status, and details about the HDD.
- Click the **HDD Time** to view the record information in the HDD.



Figure 5-66 HDD information

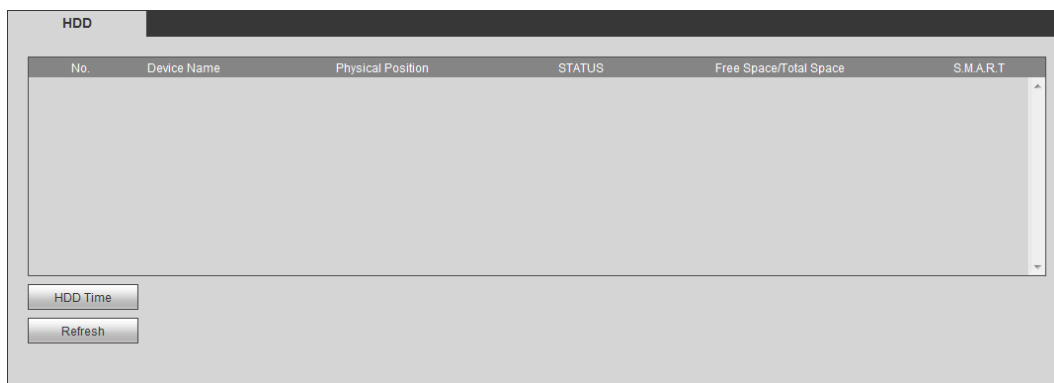
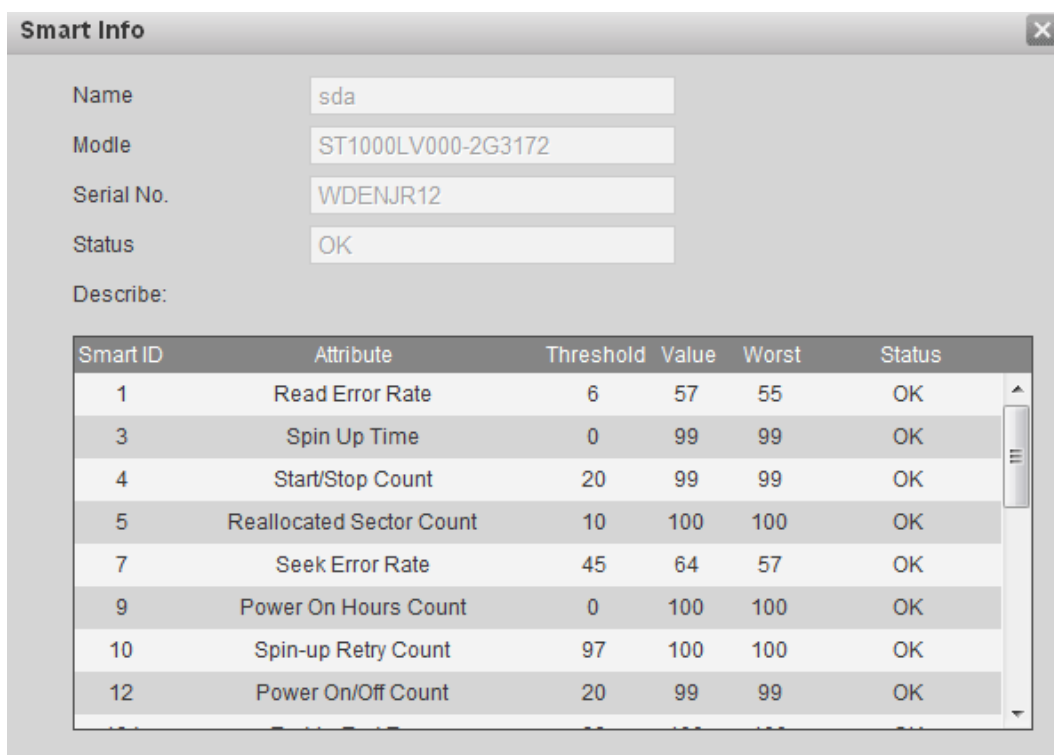

Figure 5-67 Smart Info



## 5.5.5 Configuring system settings

Set up system information, including the output mode, serial port parameters, and user account management.

### 5.5.5.1 Configuring Zero-Ch Encode Settings

You can configure the parameters such as compression mode, resolution, and frame rate for Zero-Channel view.

**Step 1** Select **Setup > System > Display Output**.

The **Zero-Ch Encode** interface is displayed. See Figure 5-68.

Figure 5-68 Zero-Ch Encode

**Step 2** Select the **Enable** check box to enable this function. It is enabled by default.

**Step 3** Sets up DBHA parameters. See Table 5-31 for details.

Table 5-31 Multi-channel encode parameters description

Name	Description
Encode Mode	Encode Mode of video Only H.264 encoding is available in this device
Resolution	The higher the video resolution, the better the image quality
FPS	Configure the frames per seconds for video. The larger the value is, the smoother and more vivid the image will be.
Bit Rate	Select a value for bit rate of video

**Step 4** Click **Save**.

The zero-ch encode icon is displayed on the PREVIEW interface. For details, see “5.4.1.6Multi-channel preview.”

### 5.5.5.2 Configuring RS-232 Port Parameters

You can configure the RS-232 serial port parameters such as baud rate, date bits, stop bits, and parity.

**Step 1** Select SETUP > SYSTEM MANAGEMENT > RS232

The RS232 settings interface is displayed, see Figure 5-69.

Figure 5-69 RS232 settings

Step 2 Sets up DBHA parameters. See Table 5-32 for details.

Table 5-32 Serial port parameter description

Name	Description
Function	Select the corresponding protocol <ul style="list-style-type: none"> <li>• Console: Upgrades programs and debug by suing the serial interface and mini terminal software</li> <li>• Vehicle lamp box: An external vehicle lamp box can be connected.</li> </ul>
Baud rate	The times of signal changes on the transmission line in time unit <ul style="list-style-type: none"> <li>• For a console, the default baud rate is 115200</li> <li>• The default baud rate of the vehicle lamp box is 9600.</li> </ul>
Data bit	Select a data bit. The options include <b>5,6, 7, and 8</b>
Stop bit	Select a stop bit. The options includes <b>1, 1.5, and 2</b>
Parity	Select a parity mode from None, Odd, Even, Mark, and Null

Step 3 Click **Save**.

### 5.5.5.3 Managing User Account

You can add, modify and delete user accounts and groups, and configure security questions for admin account.

#### The Default User and Authority

The default user account is admin.

- The admin account is defined as the high privileged user by default.
- To manage the user account easily, when defining the user account authority, it is recommended to give lower authority to the common user account than the advanced user account.

#### About User and User Group

You can manage the account by user and user group, and the name cannot be repeated.

- You can set maximum 64 users and 20 groups.
- The default group name by "User" and "Admin" cannot be deleted.
- Select the authorities to the user of a group. However, the authorities of the admin account cannot be randomly specified.
- Every user must belong to only one group. When selecting a group for a user, the authority that the user can be given should be no higher than the group authority.
- Both the username and group support 1–31 characters and can only consist of letter, number, underline (\_), and hyphen (-).

### 5.5.5.3.1 User Management

You can add, delete, or modify user, and set the authorities for the user of a group.

## Add User

**Step 1** Select **Setting > System > Account > User**.

The system displays the **User** interface. See Figure 5-70.

Figure 5-70 User

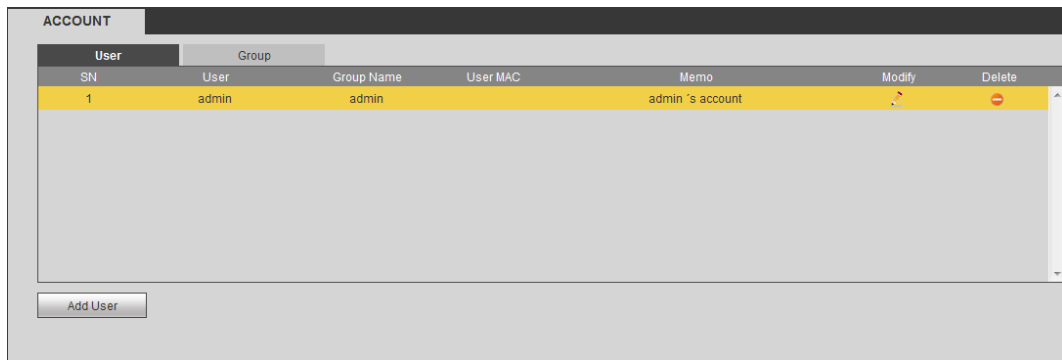

**Step 2** Click **Add User**.

The **Add User** interface is displayed. See Figure 5-71.

Figure 5-71 Add User

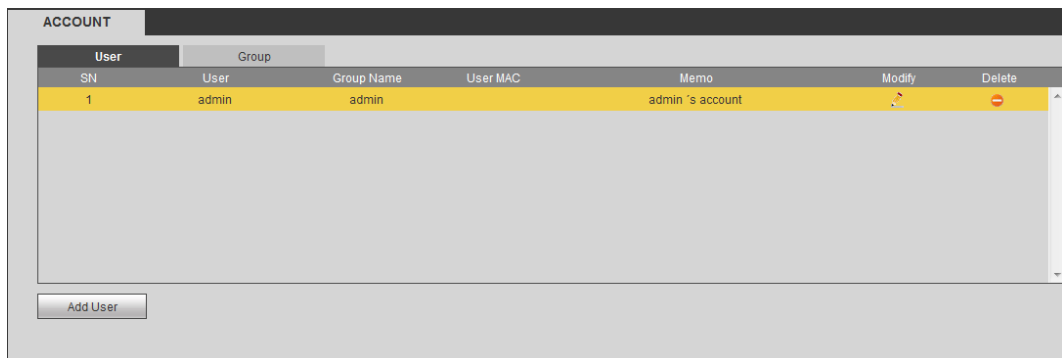

**Step 3** Sets up DBHA parameters. See Table 5-33 for details.



Table 5-33 Parameters description for adding user

Name	Description
Username	Enter the user name and password, and conform the password
Password	
Confirm Pwd	
Reusable	Select the check box, user name can also be used to login the web
Group name	Select a group for the user

Name	Description
User MAC	Enter user MAC address that is allowed to login the Device
Remarks	Enter a description of the user
Authority	<p>Select the authorities to the user of a group.</p> <p> <b>NOTE</b></p> <ul style="list-style-type: none"> <li>• The authorities of the admin account cannot be changed</li> <li>• To manage account easily, when defining the user account authority, it is recommended to give lower authority to the common user account than the advanced user account Authority</li> </ul>

**Step 4** Click **Save**.

 **NOTE**

Click  to modify user information; click  to delete the user.

## Change Password

**Step 1** On the **User** interface, click .

The **Modify User** interface appears. See Figure 5-72.

Figure 5-72 Change Password

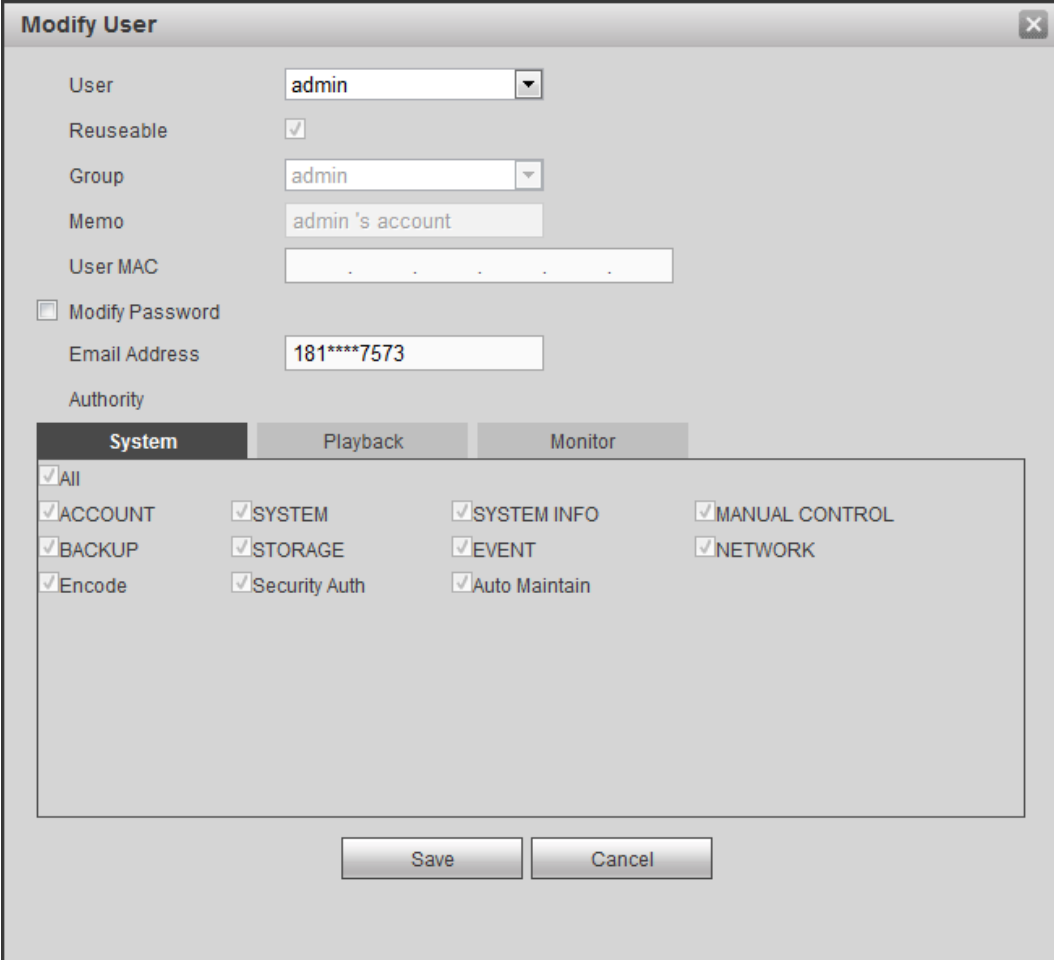

**Step 2** Select the **Modify Password** check box, and then enter old password, new password, and confirm password in the corresponding box.

**Step 3** (Optional) Set up the reserved phone number.

Set up the reserved phone number. The system pops up a message to ask you whether sync to the remote devices that are accessed through the default protocol.

- If you select **Cancel**, the system does not sync to your phone and does not find the remote device connected through the default protocol.
- If you select **Save**, the system syncs to your phone to find the remote device connected through the default protocol.

 **NOTE**

Setting up a reserved phone number lets you reset the login password of the admin account if it was lost. See 5.5.5.3.3Reset Password.

Step 4 Click **Save**.

 **NOTE**

- The new password can be set from 8 characters through 32 characters and contains at least two types from number, letter and special characters (excluding ' " ; :Please enter a strong password according to the password strength indication.
- A user authorized to manage user accounts can modify its own password and the passwords of other users.

### 5.5.5.3.2 Group Management





You can perform the operations to manage the group account, such as adding a group, deleting a group, and modifying a group.

Step 1 Select **Setup > System > User > User Group**.

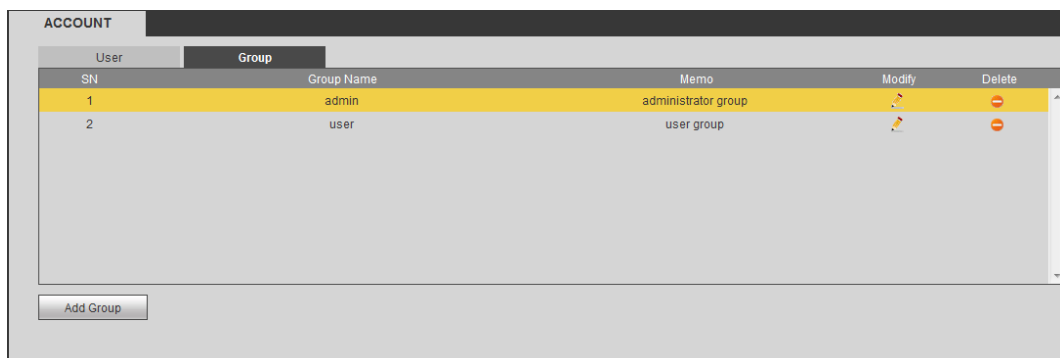
The Group name interface is displayed, see Figure 5-73.

Figure 5-73 Group name



SN	Group Name	Memo	Modify	Delete
1	admin	administrator group		
2	user	user group		

Step 2 Click Add Group.

The **Add Group** interface is displayed. See Figure 5-74.

Figure 5-74 Add group



The screenshot shows a window titled "Add Group" with a close button in the top right corner. Below the title bar, there are three text input fields labeled "Group Name", "Memo", and "Authority". Under the "Authority" field, there are three tabs: "System", "Playback", and "Monitor". The "System" tab is selected and contains a list of checkboxes: "All", "ACCOUNT", "STORAGE", "Security Auth", "SYSTEM", "EVENT", "BACKUP", "SYSTEM INFO", "NETWORK", "Auto Maintain", "MANUAL CONTROL", and "Encode". At the bottom of the dialog, there are "Save" and "Cancel" buttons.

**Step 3** Enter **User Group** and **Memo**.

**Step 4** Select authority control, including system, playback, and monitor.

**Step 5** Click **Save**.

 **NOTE**

Click  to modify the corresponding group information; click  to delete the group.

### 5.5.5.3.3 Reset Password

You can reset the password through the reserved phone number when the password for the admin account is lost.

**Step 1** Open a browser and login the web interface of Device.

The login interface is displayed.

**Step 2** Enter the username admin.

The password setting information is displayed. See Figure 5-75.

Figure 5-75 Login Interface



**Step 3** Click **Forgot password?**

The **Reset** dialog box is displayed.

**Step 4** Click **Save**.

The **Reset the password** is displayed. See Figure 5-76

Figure 5-76 Reset password (2)



**Step 5** Follow the on-screen instructions to scan the QR code and get the security code.

### **CAUTION**

- Scan the QR code on the actual interface of Device.
- You can get the security code twice by scanning the same QR code. If you need to get the security code once again, please refresh the interface.
- The security code is valid for 24 hours.
- Wrong security code entrance up to five times will cause the admin account locked for five minutes.

**Step 6** In the security code box, enter the security code received in your reserved email box.

**Step 7** Click **Next**.

The Reset the password interface is displayed. See Figure 5-77.



Figure 5-77 New password setting

**Reset the password2/2**

Username            admin

New Password       

                         Weak Moderate Strong

Use a password that has 8 to 32 characters, it can be a combination of letter(s), number(s) and symbol(s) with at least two kinds of them.(please do not use special symbols like ' ' ; : & )

Confirm Password   

                         Cancel            Save

**Step 8** In the New Password box, enter the **New Password** and enter it again in the **Confirm Password** box.

The new password can be set from 8 characters through 32 characters and contains at least two types from number, letter and special characters (excluding ' ' ; : Please set a high security password according to the prompt of password strength.

**Step 9** Click **Save**.

The system prompts successful operation. You can use the new password to login to the device.

#### 5.5.5.3.4 Online User

Review online user information.

Select **INFO > INFO > ONLINEUSES**, the **Online User** interface is displayed. See Figure 5-78.

Figure 5-78 Online User

No.	Username	Group Name	IP Address	User Login Time
1	admin	admin		2019-01-04 19:02:59

Refresh

## 5.5.6 Safety

### 5.5.6.1 Set up system services

**Step 1** Select **SETUP > SECURITY MANAGEMENT > SYSTEM SERVICE**.

The **System Service** interface is displayed. See Figure 5-79.

Figure 5-79 System service

**System Service**

Password Reset

Mobile Phone Push

---

CGI

---

Audio/Video Transmission Encryption  **The corresponding device or software shall support video decryption function.**

Save Refresh Default

**Step 2** Select whether to enable password reset, CGI, or audio/video transmission encryption.

- After password reset is enabled, you can reset the password of the device by using your reserved phone number or through QR code when necessary.
- The P2P client can receive the alarm push information only after the mobile phone push is enabled and the P2P client subscribes to the alarm.
- After enabling CGI, the third-party platform can connect to this device through the CGI protocol.
- When enabled, this function encrypts audio/video transmission. Related devices or software shall support video decryption.

**Step 3** Click **Save**.

## 5.5.6.2 HTTPS Settings

Through creating server certificate or downloading root certificate, and setting port number, the PC can login the Device by HTTPS to ensure the security of communication data and guard the users information and device security with stable technology measure.

### Preconditions

On the **Connection Setting** interface, select the **Enable** check box for HTTPS Port. Then you can start creating server certificate or downloading root certificate. For details, see “5.5.2.1 Connection Setting.”

#### 5.5.6.2.1 Create server certificate

For the first time to use this function or after changing the Device IP address, you need to create server certificate.

**Step 1** Select **SETUP > SECURITY MANAGEMENT > HTTPS**.

The **HTTPS** interface is displayed. See Figure 5-80.

Figure 5-80 HTTPS



**Step 2** Click **Create Server Certificate**.

The **Create Server Certificate** interface is displayed. See Figure 5-81.

Figure 5-81 Create server certificate

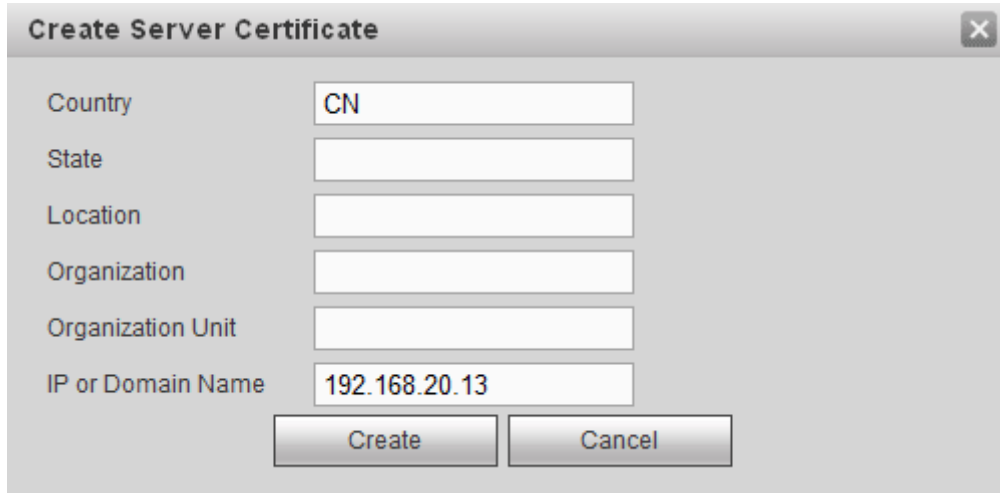

**Step 3** Enter the information for the parameters such as Country, State, and Location.

 **NOTE**

In **IP or Domain Name** box, enter the same IP or domain name of the Device.

**Step 4** Click **Create**.

The system pops up a message after the creating is succeeded.

### 5.5.6.2.2 Root certificate Installation

For the first time to use HTTPS after changing the PC, you need to download root certificate.

**Step 1** Select **SETUP > SECURITY MANAGEMENT > HTTPS**.

The **HTTPS** interface is displayed. See Figure 5-80.

**Step 2** Click **Download Root Certificate**.

The **File Download** interface is displayed. See Figure 5-82.

Figure 5-82 File Download



Step 3 Click **On**.

The **Certificate** page is displayed. See Figure 5-83.

Figure 5-83 Certificate

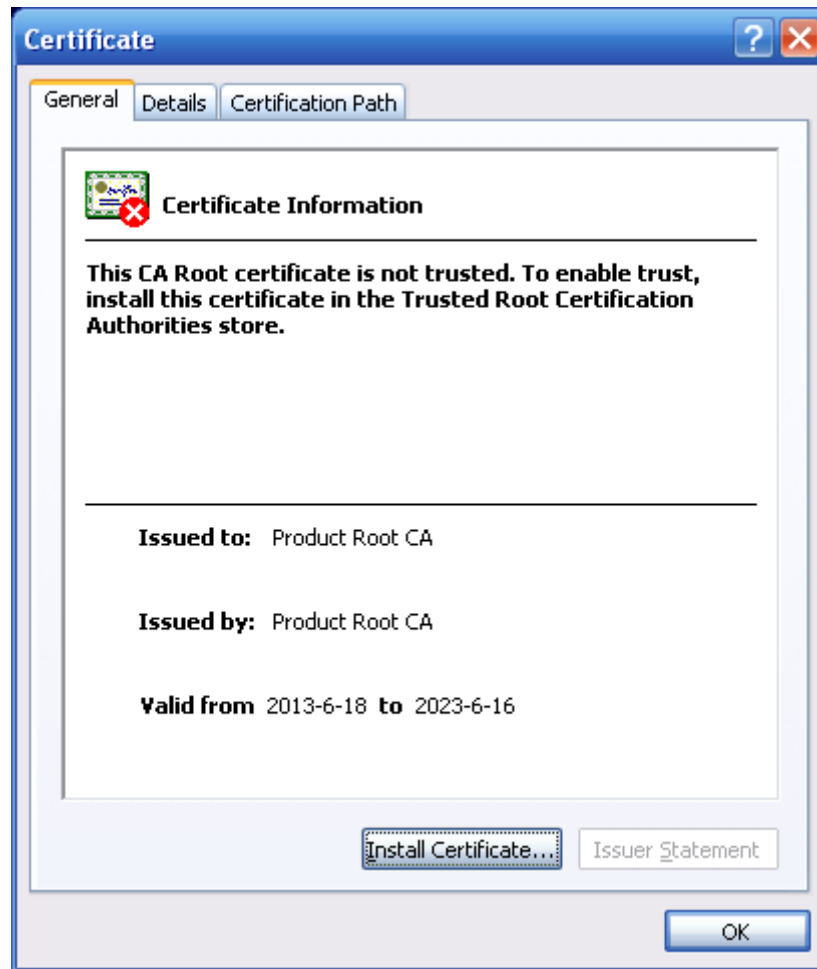

Step 4 Click **Install Certificate**.

The **Certificate Import Wizard** interface is displayed. See Figure 5-84.

Figure 5-84 Certificate import wizard



Step 5 Click **Next**.

The **Certificate Store** interface is displayed. See Figure 5-85.

Figure 5-85 Certificate store

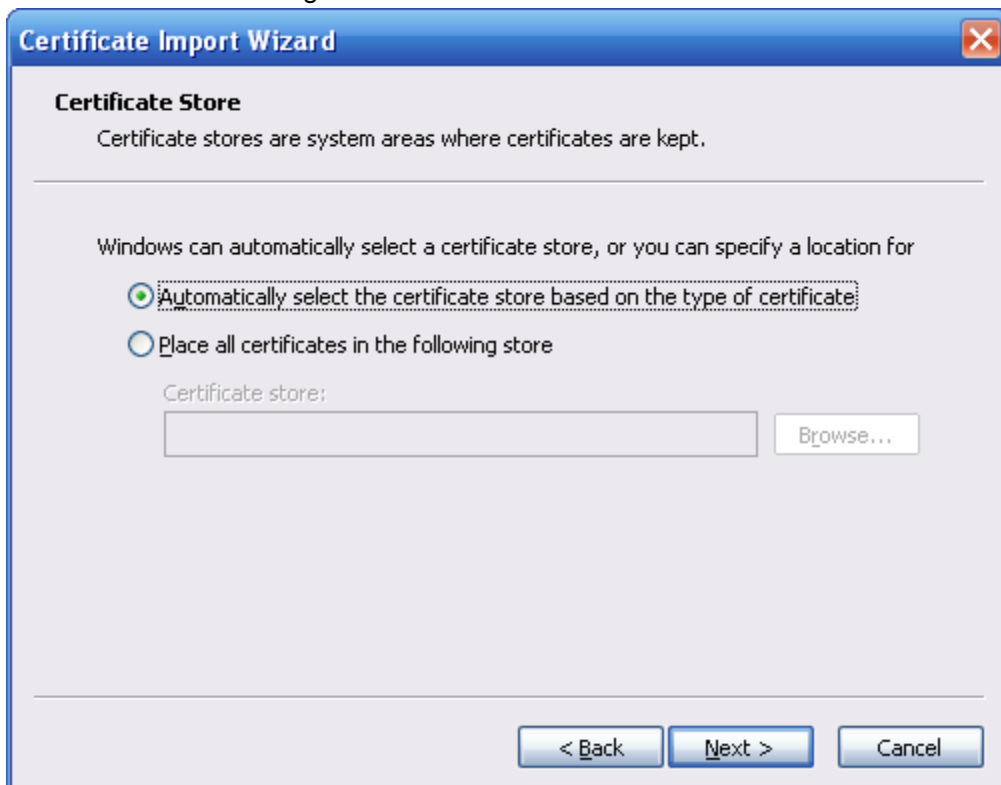

Step 6 Click **Next**.

The **Completing the certificate import wizard** interface is displayed. See Figure 5-86.

Figure 5-86 Completing the certificate import wizard certificate import wizard

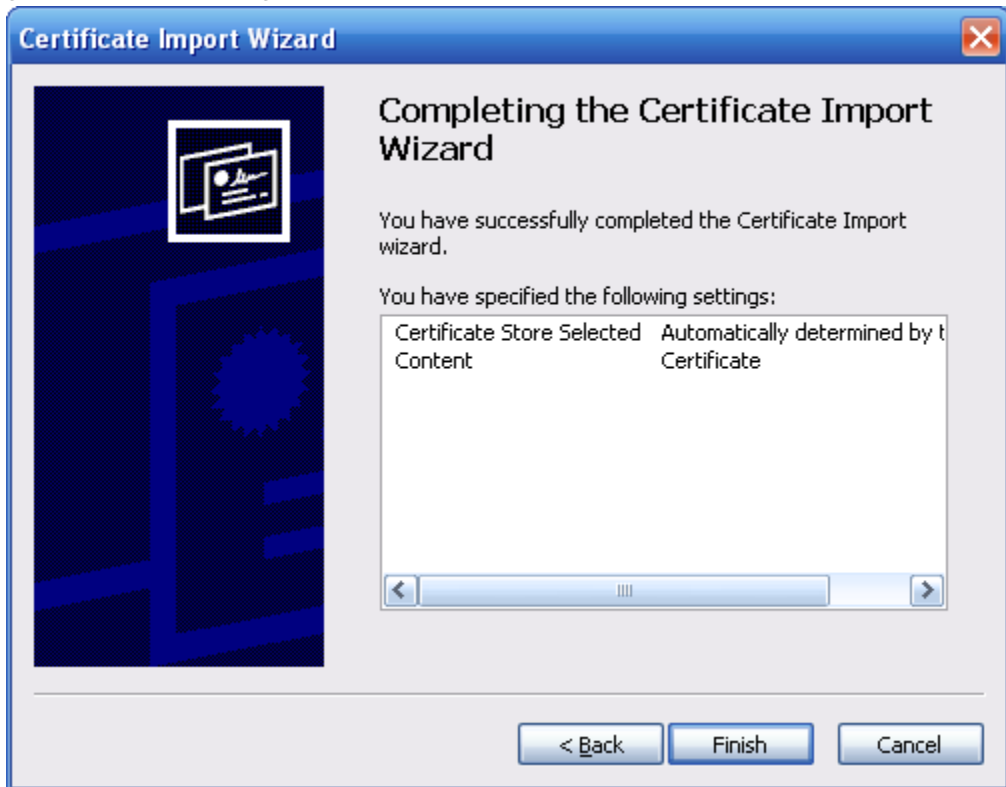

**Step 7** Click **Finish**.

The **Security Warning** interface is displayed.

**Step 8** Click **Yes**.

The **Import Completed** page is displayed. The certificate has been downloaded at this point.

### 5.5.6.2.3 Set up HTTPS Port

After creating server certificate or downloading the root certificate, you need to set up the HTTPS port.

**Step 1** Select **Setup > Network > Connection Setting**.

The **Connection Setting** interface is displayed. See Figure 5-87.

Figure 5-87 HTTPS port settings

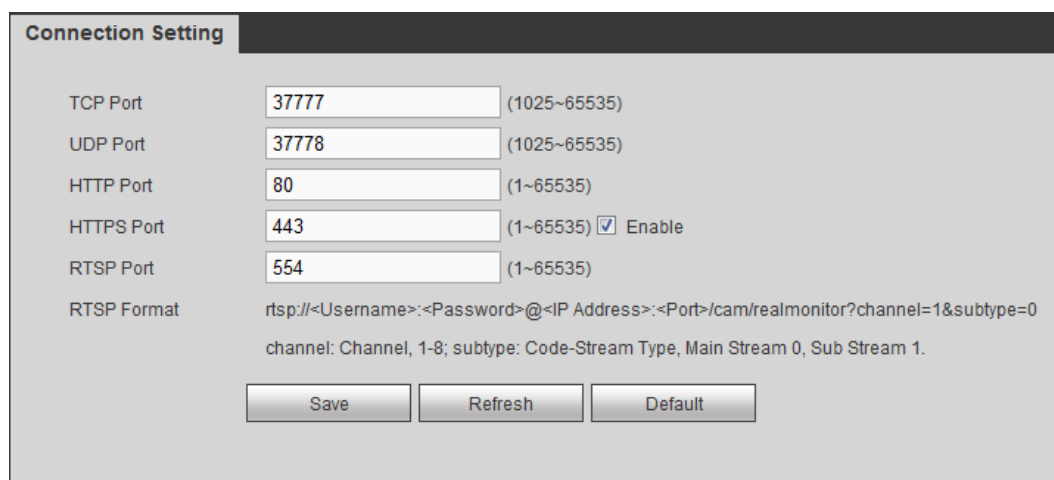

**Step 2** Enter the HTTPS port number that can be modified as needed. The default setting is 443.

Add the port number if it was modified to login to the device with the HTTPS.

Step 3 Click **Save**.

### 5.5.6.2.4 Logging through HTTPS

Use HTTPS to login to the WEB interface of the device.

Open the browser, enter `https://xx.xx.xx.xx:port`, the login interface is displayed.

#### NOTE

- `xx.xx.xx.xx` corresponds to your Device IP address or domain name.
- “Port” corresponds to your HTTPS port. If the default value is 443, do not enter “:Port”. Just enter “`https://xx.xx.xx.xx`” to visit.

## 5.5.7 Configuring Vehicle Settings

Set up the speed, mileage, sensor, and position report strategy of the vehicle.

### 5.5.7.1 Configuring Speed

Step 1 Select **SETUP > VEHICLE > SPEED**.

The **SPEED** interface is displayed. See Figure 5-88.

Figure 5-88 Speed

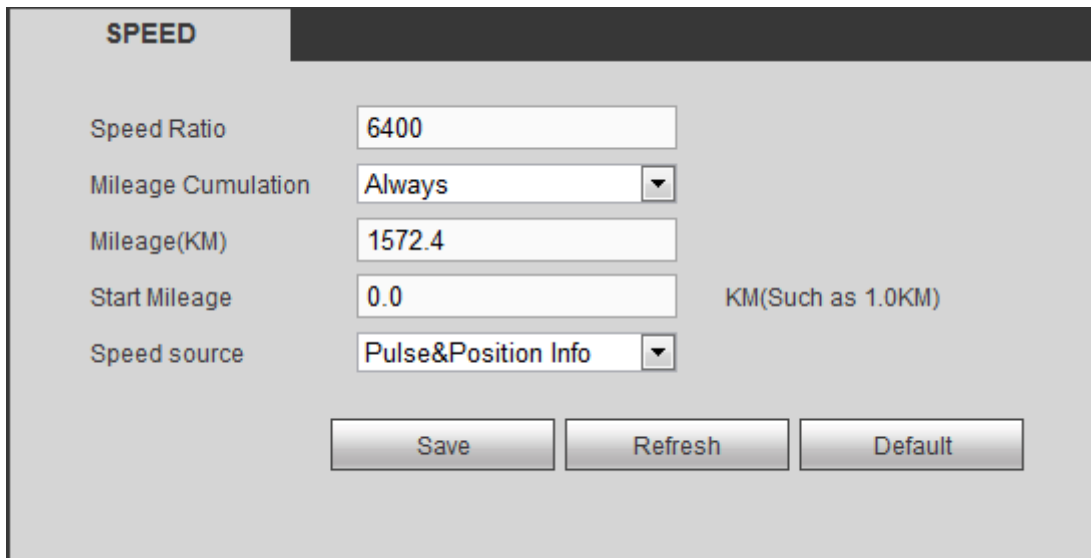

The screenshot shows a web interface for configuring vehicle speed settings. The title is "SPEED". It contains the following fields and controls:

- Speed Ratio: 6400
- Mileage Cumulation: Always (dropdown menu)
- Mileage(KM): 1572.4
- Start Mileage: 0.0 (with a note "KM(Such as 1.0KM)")
- Speed source: Pulse&Position Info (dropdown menu)

At the bottom, there are three buttons: "Save", "Refresh", and "Default".

Step 2 Sets up DBHA parameters. See Table 5-34 for details.

Table 5-34 Speed parameters description

Name	Description
Speed Ratio	The parameter for converting speed
Mileage Cumulation	Select the vehicle mileage cumulation mode
Mileage	Displays the total mileage
Start Mileage	Enter the initial mileage of the vehicle

Name	Description
Speed source	Select where the speed is obtained, including <b>Pulse</b> , <b>Positioning Info</b> , and <b>Pulse&amp;Positioning Info</b> <ul style="list-style-type: none"> <li>• Pulse 1: Get the speed information from vehicle pulse system</li> <li>• Positioning Info: Get the speed information from positioning system</li> <li>• Pulse&amp;Positioning Info: Get the speed data from both the pulse system and positioning system. Data from the impulse system is used first</li> </ul>

Step 3 Click **Save**.

### 5.5.7.2 Sensor settings

Used to detect the rollover, collision, sharp turn, rapid acceleration or deceleration of the vehicle.

Step 1 Select **SETUP > VEHICLE > SENSOR SETTINGS**.

The Sensor Settings interface is displayed. See Figure 5-89.

Figure 5-89 G-SENSOR

Step 2 Sets up DBHA parameters. See Table 5-35 for details.

Table 5-35 Sensor parameters

Name	Description
Type of vehicle head side axle	Select the type of vehicle head side axle coordinates and the tilt angle of the slope
Inclination angle of slope (Unit: °)	Vehicle head side axles include X/Y/Z axles Only when the <b>Vehicle Head Side Shaft</b> is not <b>Undetermined</b> can the system detect the rapid acceleration and deceleration events of the vehicle.

Step 3 Click **Save**.

### Position Correction

You can correct the device position on the Local interface.

The default values displayed on the interface can deviate from the actual installation position. Without correction, the vehicle running as intended can also trigger an alarm.

In the main menu, select **Other Settings > Vehicle > Gyro**. The **Gyro** interface is displayed. See Figure 5-90.

Click **Correct Position** to correct the vehicle position.



Figure 5-90 G-SENSOR

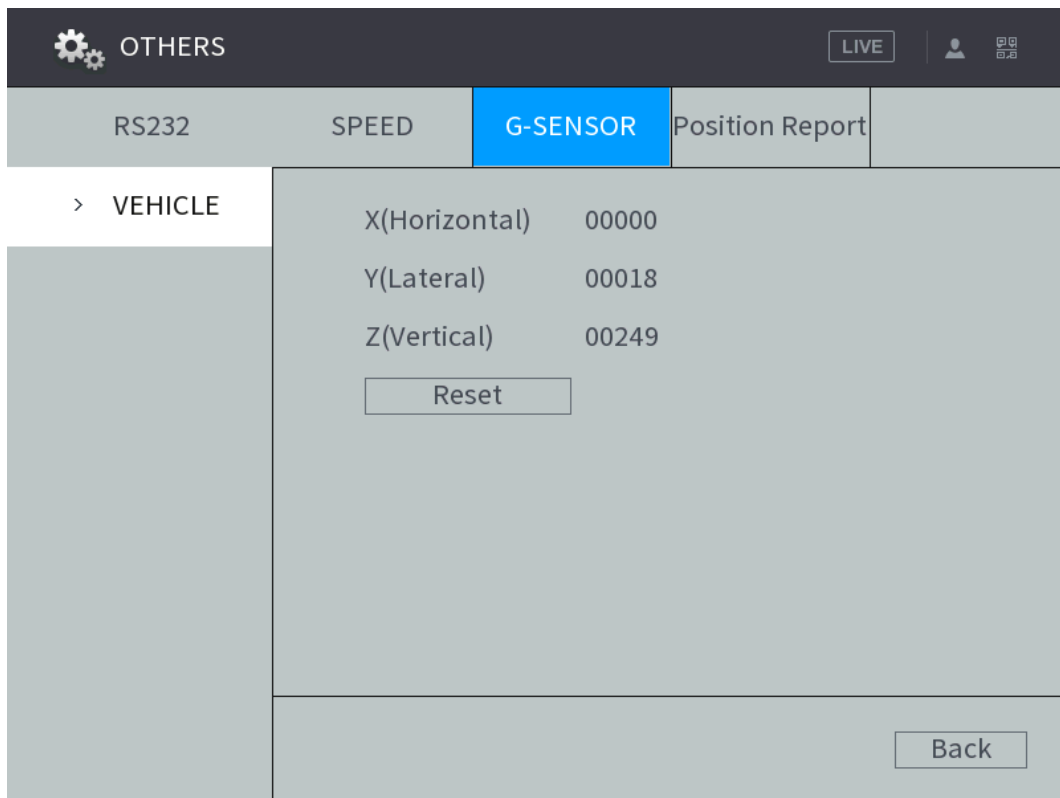

### 5.5.7.3 Configuring Position Report

You can configure the position report strategy to be device auto report or report per platform schedule.

**Step 1** Select **SETUP > VEHICLE > Position Report**.

The **Position Report** interface is displayed.

**Step 2** Configure the report strategy.

- Auto report.
  4. In the **Report Strategy** list, select **Device Auto**.

The **Device Auto** setting interface is displayed. See Figure 5-91.

Figure 5-91 Position report (device auto)

**Position Report**

Report Strategy: Device Auto

Report Interval: 30 sec. (1-300)

Report by Distance: 100 Meter(m) (50-500)

Inflexion Angle: 30 Degree(s) (30-120)

Report Interval When ACC off: 60 sec. (1-600)

Buttons: Save, Refresh, Default

5. Configure TCP/IP parameters. For details, see Table 5-36.

Table 5-36 Device auto report parameters description

Name	Description
Report Interval	When the vehicle ACC status is on, the system report the position to platform according to the configured report interval, report distance, and inflexion angle
Report by Distance	
Inflexion Angle	
Report Interval When ACC off	When the vehicle ACC status is off, the system report the position to platform according to the configured report interval

- Platform schedule.

In the **Report Strategy** list, select **Platform Schedule**. The **Platform Schedule** setting interface is displayed. See Figure 5-92.

The platform obtains the device position by the configured schedule. The schedule is configured at the Platform. See the User's Manual of the platform.

Figure 5-92 Position report (platform schedule)

**Position Report**

Report Strategy: Platform Schedule

Buttons: Save, Refresh, Default

**Step 3** Click **Save**.

## 5.6 System Update

### 5.6.1 View system version

You can view the Device version information.

Select **INFO > INFO > VERSION INFO**. Device type, recording channel, system version and other information are displayed.

### 5.6.2 Upgrading System Firmwares

You can import the upgrading file to upgrade the system. The upgrade file should be a .bin file.

#### CAUTION

- During upgrading, do not disconnect from power and network, and reboot or shut down the Device.
- Upgrading the wrong file might result in the Device not working properly.

**Step 1** Select **Setting > System > System Upgrade**.

The Upgrade interface is displayed. See Figure 5-93.

Figure 5-93 System Update

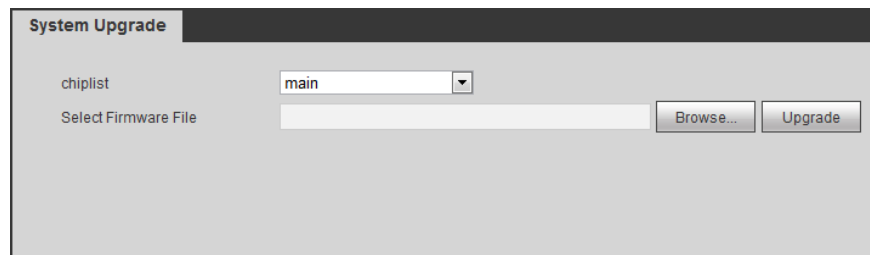

**Step 2** Select the chip list that suits your actual needs.

- To upgrade system programs, select main chip for the chip list.
- To upgrade the MCU firmware programs, select MCU for the chip list.

**Step 3** Click **Import** and select the upgrade file you want to upgrade.

**Step 4** Click **Update**.

The system starts upgrading. You should login to the web again after upgrading.

## 5.7 System Maintenance

### 5.7.1 Requirement for Maintenance

For the system's good and safe running, it's recommended to manage and maintain the system, backup files in the following methods.

- Check surveillance images regularly.
- Clear not frequently-used user and user group regularly.
- Modify your password every 3 months.

- Check your system log regularly. Handle problems asap.
- Backup your configuration of system regularly.
- Reboot this device regularly.
- Upgrade firmwares regularly.

## 5.7.2 System Information

Review the running status, version information, system log, and satellite info of the device.

### 5.7.2.1 Viewing System Log

You can search, view, and back up the system logs to PC.

**Step 1** Select **INFO > INFO > LOG**.

The Log interface is displayed. See Figure 5-94.

Figure 5-94 System log

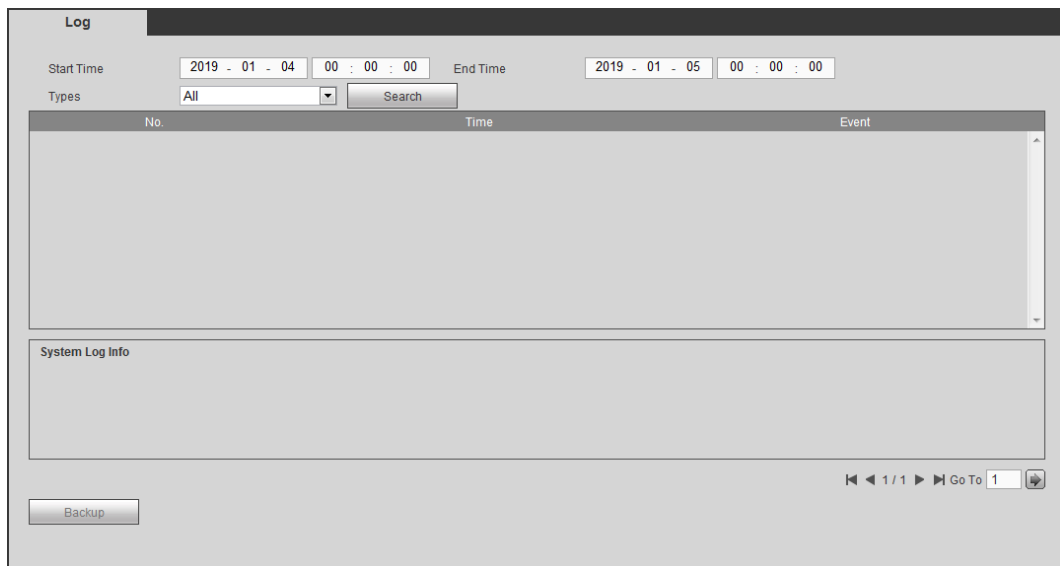

**Step 2** Set up **Start Time**, **End Time**, and **Types**.

**Step 3** Click **Search**.

The searched logs are displayed.



Select the log that you want to back up, and then click **Backup**. In the **Save as** dialog box, select the save path to save the log to PC.

### 5.7.2.2 Viewing Satellite Info

You can view the satellite positioning information such as module state, positioning status, latitude and longitude, and search results.

Select **INFO > INFO > SATELLITE INFO**. The **SATELLITE INFO** interface is displayed. See Figure 5-95.

Click **Refresh** and the latest satellite information is displayed.



- If the GPS module state indicates Normal and does not position within five minutes, the GPS module automatically resets and re-position. When the positioning information is

obtained again, the GPS module reset times is up to 20, or the Device is rebooted, you can view the GPS module reset records in the log.

- When the GPS module is short-circuited for more than 10 seconds, the module status is abnormal and the GPS module is automatically powered off and no longer powered on. After the Device is rebooted, the GPS module will be powered on again.

Figure 5-95 Satellite information

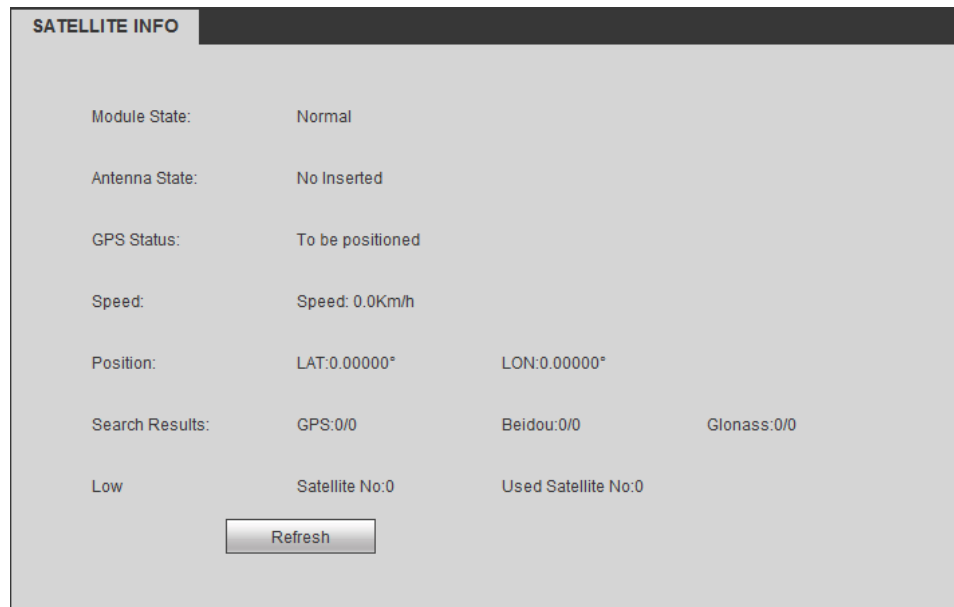

## 5.7.3 Auto Maintain

You can configure the automatic maintenance settings such as auto reboot, auto deleting old files, auto booting up, auto shutdown, and delay for auto shutdown.

### 5.7.3.1 Reboot system

After configuring auto reboot, when the Device is working, it reboots according to the schedule.

**Step 1** Select **Setting > System > Auto Maintain**.

The Auto Maintain interface is displayed, see Figure 5-96.

Figure 5-96 Auto Maintain

The screenshot shows the 'Auto Maintain' configuration window. It includes the following settings:

- Auto Reboot: Never (dropdown), 00:00 (time field)
- Auto Delete Old Files: Never (dropdown)
- Auto Boot up: Never (dropdown), 00:00 (time field)
- Auto Shutdown System: Never (dropdown), 00:00 (time field)
- ACC Delay: 5 (text input), Minute (label)

Buttons at the bottom: Manual Reboot, Save, Refresh.

Step 2 Reboot system.

- Auto reboot: Select the time when the system auto reboots, and click **SAVE**. The system auto reboots at the specified time.
- Manual reboot: Click **Manual Reboot** and the device is rebooted immediately.

### 5.7.3.2 Configuring auto deleting old files

After configuring auto deleting old files, when the Device is working, it deletes old recordings that occurred before the set schedule.



#### CAUTION

The deleted recordings cannot be restored. Use this function with caution.

Step 1 Select **Setting > System > Auto Maintain**.

The **AUTO MAINTAIN** interface is displayed.

Step 2 In the **Auto Delete Old Files** area, select **Customized**, and then enter the days.

You can enter 1 day through 31 days.

Step 3 Click **Save**.

### 5.7.3.3 Configuring auto boot up

After configuring auto boot up, the Device boots up automatically at the scheduled time. If the vehicle key is turned to the ACC before the preset auto boot up schedule, the device boots up immediately. When the ACC of the vehicle is off after booting up, the equipment will be shut down according to the preset automatic shutdown delay time.

Step 1 Select **Setting > System > Auto Maintain**.

The **AUTO MAINTAIN** interface is displayed.

Step 2 In the Auto Boot up area, select Valid, and then enter the specific time.

Step 3 Click **Save**.

### 5.7.3.4 Configuring auto shutdown system

After configuring auto shutdown, the Device automatically shuts down according to the ACC power off time and auto boot up setting.

- If you have set the time for auto boot up, there are two situations when the ACC is powered off: If the system time is between the auto boot up and auto shutdown, the Device is turned off at the configured time. If the system time is before the auto boot up or after the auto shutdown, the Device is turned off immediately.
- If the auto boot up is not set, when the ACC is disconnected, the Device shuts down at the scheduled time.

**Step 1** Select **Setting > System > Auto Maintain**.

The **AUTO MAINTAIN** interface is displayed.

**Step 2** In Auto Shutdown System, select Everyday, and then enter the specific time.

**Step 3** Click **Save**.

### 5.7.3.5 Auto Delay for Shutdown

After configuring auto delay for shutdown, when ACC is disconnected, the Device shuts down according to the settings of auto delay for shutdown.

- If you enter the delay value that is not 0, the Device automatically shuts down after the preset delay.
- If you enter 0, the Device shuts down according to the auto shutdown settings without delay.

**Step 1** Select **Setting > System > Auto Maintain**.

The **AUTO MAINTAIN** interface is displayed.

**Step 2** Configure the auto delay for shutdown.

The value ranges from 0 through 65535. The default value is 5 minutes.

**Step 3** Click **Save**.

## 5.7.4 Backing Up and Restoring

You can back up or restore the web configurations and restore to default settings.

### 5.7.4.1 Backing up Configurations

You can back up all the configurations of web.

**Step 1** Select **SETUP > SYSTEM MANAGEMENT > CONFIGURE BACKUP**.

The Import/Export interface is displayed, see Figure 5-97.

Figure 5-97 Import/Export



**Step 2** Click **Config Export**, and select the save path.

The system starts backing up configurations.

## 5.7.4.2 Restoring Configurations

You can use the backed up configurations to quickly configure the Device and restore the device configurations.

**Step 1** Select **SETUP > SYSTEM MANAGEMENT > CONFIGURE BACKUP**.

The Import/Export interface is displayed, see Figure 5-98.

Figure 5-98 Import/Export

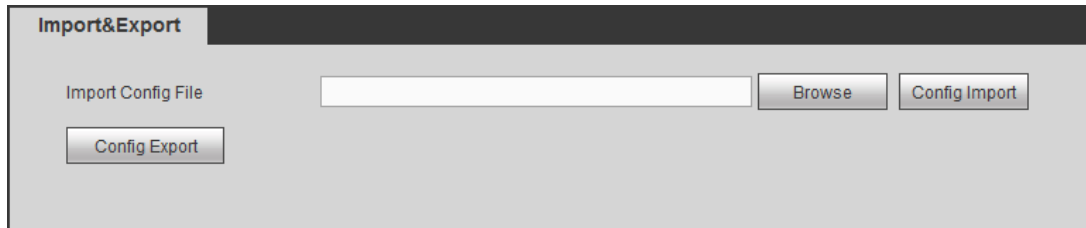

**Step 2** Click **Browse**, and then select the backup file you want to import.

**Step 3** Click **Config Import**.

The system pops up the reboot message. Click **Save**, the system starts importing the configurations and reboot the device after importing is completed.

## 5.7.4.3 Restoring to Default

You can restore the system to default configurations or the factory default. Only the user with the default&upgrade authorities can do this.

### CAUTION

The corresponding functions will be restored to the factory settings, and your current configurations will be lost. Proceed with caution.

**Step 1** Select **SETUP > SYSTEM MANAGEMENT > DEFAULT**.

The **Default** setting interface is displayed. See Figure 5-99.

Figure 5-99 Factory default setting

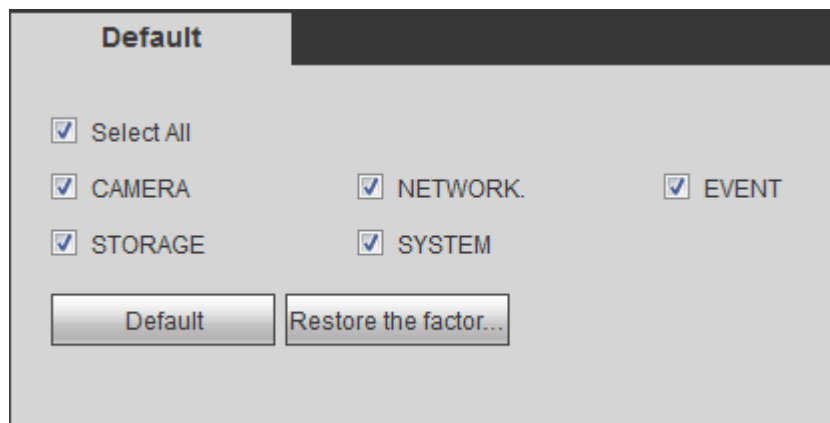

**Step 2** Select the check box of the options that you want to restore to the factory default.

- Default: Select the options, and then click **Default**. In the pop-up message, click **Save**. The selected options will be restored to the factory default settings.
- Restore the factory settings: Click **Restore the factory settings**. In the pop-up message, click **Save**. The system starts rebooting. After the device is rebooted,



the system will return to the default settings and needs to be initialized again. Proceed with caution.

When there is a user operating on the local interface, the factory default settings cannot be performed until the local user log out.

## 5.7.5 Network packet capturing

The packet data can be provided to the developers or engineers to analyze the network usage status.

### Preconditions

The device for packet capturing is connected to an external backup device.

### Steps

**Step 3** Select **INFO > INFO > NETWORK SNIFFER**.

The **NETWORK SNIFFER** interface is displayed, see Figure 5-100.

Figure 5-100 Network sniffer



**Step 4** Select the Ethernet card and save path.

**Step 5** Select the Target Filter check box, and then enter the IP address that you want to filter.

**Step 6** Click **Start**.

The system indicates the start of capturing, and the packet data will be stored in the external backup device.

**Step 7** Click **Stop**.

The system pops up a prompt.

**Step 8** Click **Download** or **Cancel** to finish the packet capturing.

Click **Download** to download the packet data to the local, where you can view the file in the saved path. Click **Cancel** to not download the packet data.

# 6

## Operating by DSS

Beside from web, you can also remotely login the Device from Digital Surveillance System (DSS).

For details, see the manual of DSS.

If your questions cannot be answered by the following contents, please contact your local service engineer or the service of our Headquarters for help. We can guide you to solve this problem.

**1) Q: Disconnect the constant electricity but the device is still working.**

A: Possible causes:

- The default 5-minute shutdown delay is effective.
- The UPS setting provides constant power supply to the device when the lithium battery voltage is above 7V.
- ACC is connected.

**2) Q: The device gives squeal after start.**

A: Possible causes:

- Connecting to the display and being too close to the camera.
- A single channel interface or a large-image multi-channel interface. The first route of sound comes from a local source.

**3) Q: The interface shows that no SIM card is detected.**

A: Possible causes:

- SIM card not inserted.
- Micro SIM card reversely inserted with its notch facing outward. Follow instructions on the label to insert the SIM card.
- SIM card is damaged.

**4) Q: DVR cannot boot up properly.**

A: Possible causes:

- The input power is not correct; the input voltage is too low or too high.
- Poor contact in the input power cable or incorrect wiring.
- Main board is damaged.

**5) Q: DVR automatically reboots or frequently crashes.**

A: There are the following possibilities

- Input voltage is not stable or too low.
- The Device is not properly installed, which result in poor contact between components.
- Poor heat dissipation and too many dusts result in poor working environment for the Device.
- Hardware malfunction.

**6) Q: Blank screen in a channel of the display**

A: Possible causes:

- A camera is damaged. Replace the damaged camera.
- The connection wire is damaged. Replace the damaged connection wire.

**7) Q: No video output from single-channel, multiple-channel or all-channel.**

A: Possible causes:

- Program is not compatible. Please upgrade to the correct version.
- Brightness value of all channel is 0. Please restore to default setting.
- No video input signal or the signal is too weak.
- Channel protection or screen protection is configured.
- Hardware malfunction.

**8) Q: Real-time video image is abnormal, such as color and brightness is distorted.**

A: Possible causes:

- NTSC and PAL settings are not correct, and the image becomes black and white.
- Device and monitor resistance is not compatible.
- Video network transmission distance is too far or transmission line signal attenuation is too much.
- NVR color or brightness settings are not correct.

**9) Q: No recorded video can be found in local playback.**

A: Possible causes:

- SD card has poor contact
- SD card is broken
- Upgraded program is not compatible.
- The recording file that you want to search has been overlapped.
- The recorded file is not opened.

**10) Q: Video is distorted in local search.**

A: Possible causes:

- Video quality setting is too low.
- Program read error, bit data is too small, and there is full of mosaic in the screen.  
Please firstly try to restart the DVR to solve this problem.
- SD card has a failure
- Hardware malfunction.

**11) Q: The monitor has no sound.**

A: Possible causes:

- It is not an active speaker.
- Audio cable is damaged.
- Hardware malfunction.

**12) Q: There is audio under monitoring state but no audio under playback state.**

A: Possible causes:

- Audio function is not enabled.
- The corresponding channel does not connect to the camera. Playback is not continuous when the screen is blue.

**13) Q: System time is not correct.**

A: Possible causes:

- Setting is not correct.
- Poor battery contact or voltage is too low.
- Crystal oscillator is poor.

**14) Q: USB backup error.**

A: Possible causes:

- Too much data which occupies CPU resources. Please stop recording first and then begin backup.
- Backup device is not compatible.
- Backup device is damaged.
- The backup device features high power and needs separate power supply.

**15) Q: Alarm function does not work.**

A: Possible causes:

- Alarm setting is not correct.
- Alarm cable connection is not correct.
- Alarm input signal is not correct.
- There are two loops connected to one alarm device.

**16) Q: Messy channel display.**

A: Possible causes:

- Incorrect selection of camera type. Auto switch is recommended.
- The camera is damaged.

**17) Q: Record storage time is not enough.**

A: Possible causes:

- Low camera quality, dirty lens, camera installed against the light, or iris not properly adjusted caused large big rate.
- SD card capacity is not enough.
- Part of SD card is broken

**18) Q: No 3G/4G dial-up. No dial-up IP,**

A: Possible causes:

- Check if the SIM card is normal.
- Check if the SIM card is not in service.
- Check if the 3G/4G antenna is connected as intended.

- Check if the 3G/4G signals are strong enough.
- Try out with another SIM card.

**19) Q: 3G/4G platform is not online.**

A: Possible causes:

- Check if 3G/4G dial-up is normal.
- Check if local active registration is correctly set up.
- Check if the sever terminal is correctly set up.

**20) Q: No GPS data.**

A: Possible causes:

- Check if the GPS antenna is connected as intended.
- Make sure the GPS antenna is in a place where signals are not blocked.

**21) Q: GPS drifting and produces speed for no reason.**

A: Possible causes:

Weak GPS signal.

**22) Q: Video record is silent.**

A: Possible causes:





Check if a normal analog camera is connected. Only HDCVI camera with audio input supports audio.

# Appendix 1 Mouse Operations

## NOTE

The operations are based on the considerations for right-handed users.

Beside the operations from the front panel and remote control, you can also use mouse to operate menus. Insert the mouse to the USB port of the Device.

Operation	Function
	If the user has not logged into the system, the password box is displayed first. During real-time monitoring, click the left mouse button to go to the main menu.
	When you have selected one menu item, click it to view menu content.
	Implement the operations indicated on the control.
	Change the status of the check box
	Click the combo box, the drop-down list is displayed.
	<p>In text box, click the corresponding button on the panel to enter a numeral, punctuation, English character (small/capitalized), or Chinese. Left-click the symbol on the panel to complete value input; ← represents backspace, and _ represents space.</p> <p>In English input mode: Click _ to enter a space, and click ← to delete the previous character.</p>
Click the left mouse button	<div style="display: flex; justify-content: space-around; align-items: center;">   </div>
	<p>In numeral input mode: Click _ to delete all numbers, and click ← to delete the previous number.</p>
	
	<p>In special characters input mode: For the numbers and characters on the soft panel, press the numbers on the front panel to enter the corresponding characters, for example, press 1 means entering /. You can also directly use the mouse to click to enter the characters.</p>
	

Operation	Function
Double-click the left mouse button	The special operation to perform a specific action. For example, double-click the recorded video file to start playback.
	In multi-image, double-click a channel image to display it in full screen. Double-click again to restore the previous multi-window screen.
Right-click	In the real-time monitoring screen, right-click on the screen, the shortcut menu is displayed. You can configure the settings including multi-image mode (related to the number of routes of the device), PTZ control, color setting, recording search, recording control, alarm output, and main menu. To use PTZ control and color setting apply to the images corresponding to the pointer. If it was multi-image mode before settings, the system auto switches to the single images of corresponding channels first.
	Do not save the setting and exit the current menu.
Wheel button	In numeral input box, rotate the wheel button to increase or decrease the numeral value
	Switch between items in the combo box
	Page up or page down
Move	Select and move a control of the current coordinates or one of its items
Drag	Box select an area and set up area overlap.



## Appendix 2 Storage Capacity Calculation

When the Device is installed for the first time, make sure the HDD (or SD card) is installed.

Capacity calculation formula:

Total capacity (M) = Channel quantity × Demand time length (hour) × storage capacity occupied per hour (M/hour)

Recording time calculation formula:

Recording time (hour) =  $\frac{\text{Total capacity (M)}}{\text{Storage capacity occupied per hour (M/hour) \times Channel quantity}}$

Storage capacity occupied per hour (M/hour) × Channel quantity

The Device adopts MPEG4/H.264 compression technology, which features a large dynamic range. Therefore, when calculating HDD capacity, you should accord to the bit rate to evaluate the file size generated per hour from each channel.

# Appendix 3 Technical parameters

Model		MXVR4104-4 (4 identification routes)	MXVR4104-8 (8 identification routes)
SYSTEM	Main processor	High performance industrial embedded microcontroller	
	Operating system	Embedded Linux	
	System resources	Multiplex operations, including making multichannel recording, video play back, and network operations simultaneously	
	Operation interface	User-friendly graphic menu dialog interface	
	Input device	Mouse operations, remote control operations	
	Input method	Number, English letter, symbol, expandable Chinese input	
	Shortcut functions	<ul style="list-style-type: none"> <li>The same settings in the menu can be quickly copied and pasted</li> <li>Right-click the menu to list out frequently used functions such as image split</li> <li>Double-click to directly switch between images</li> </ul>	
Compression standard	Image compression	H.265, smart H.265, H.264	
	Audio compression	G711A, G711U, G726, PCM	
Video	Video input	4 routes of complex videos (NTSC/PAL), aviation interface (1.0V <sub>P-P</sub> , 75Ω)	8 routes of complex videos (NTSC/PAL), aviation interface (1.0V <sub>P-P</sub> , 75Ω)
		One route of RJ45 interface that works with dual lenses and IPC cameras (that is two routes of digital image connection).	
	Video Output	One route of PAL/NTSC, aviation interface (1.0V <sub>P-P</sub> , 75Ω), complex video signal output; allows simultaneous TV video signal output; supports VGA output	
	Video standard	Supports PAL/NTSC	
	Video recording device	Real-time mode, 1 fps~25 fps (adjustable) per route	
	Split screen	1 image, 4 images, 6 images	1 image, 4 images, 8 images, 9 images, 16 images
	Monitor tour	Provides alarm, timed auto control and other monitoring tour functions	

Model		MXVR4104-4 (4 identification routes)	MXVR4104-8 (8 identification routes)
	Image resolution	<ul style="list-style-type: none"> <li>Allows connecting with four video routes, up to 1080P resolution</li> <li>When connecting with the analog camera, the device supports up to four routes of 960H resolution but does not support audio</li> <li>When connecting with IPC, this video enables the connection of two routes of 1080P digital image</li> </ul>	<ul style="list-style-type: none"> <li>Allows connecting with 8 video routes, up to 1080P resolution</li> <li>When connecting with the analog camera, the device supports up to four routes of 960H resolution but does not support audio</li> <li>When connecting with IPC, this video enables the connection of two routes of 1080P digital image</li> </ul>
		Provides dual streams, with the sum stream supporting up to D1 resolution and at the frame rate of 25 fps	
	Image quality	Image quality adjustable across six levels	
	Image information	Channel information, time information, covered area for confidentiality	
	TV adjustment	Adjustable TV output area to adapt to TV monitor with severe image loss	
	Channel lock-up	The monitoring image of confidential channels. When the monitoring image of a route is displayed in black screen, the actual encoded images are still normal	
		The channel is locked to limit users without permissions to review the current channel, and thus making the channel safer	
	Channel status display	The channel image can display channel name, recording status, channel locking status, and video loss status	
Color settings	Set up the hue, brightness, contrast ratio, saturation, and gains of the video input signals of each channel		
Audio	Audio input	<ul style="list-style-type: none"> <li>Four routes of aviation head input: 200mV~2000mV 10kΩ</li> <li>Built-in pickup, bound to videos of the first channel</li> </ul>	<ul style="list-style-type: none"> <li>Eight routes of aviation head input: 200mV~2000mV 10kΩ</li> <li>Built-in pickup, bound to videos of the first channel</li> </ul>
	Audio output	<ul style="list-style-type: none"> <li>One route of aviation head input: 200mV~3000mV 5kΩ</li> <li>One route of voice talk output</li> <li>One route of built-in trumpet output</li> </ul>	

Model		MXVR4104-4 (4 identification routes)	MXVR4104-8 (8 identification routes)
	<b>TTS broadcast</b>	Built-in trumpet provides TTS driving alert broadcasting	
	<b>Voice talk</b>	In voice talk, the built-in trumpet and pickup can combine to function as hand-free calls	
	<b>Voice intercom</b>	Allows voice talk by offering special car-mounted MIC and full-duplex talk terminals	
<b>LCD</b>	<b>LCD</b>	128x64 resolution, supports displaying vehicle status, speed, time, alarm information, locating information, drive information, and more	
<b>Storage</b>	<b>Hard disk</b>	One 2.5-inch HDD	
	<b>SD</b>	Two SD cards	
	<b>Cooling manner</b>	Built-in fan cooling	
<b>Recording and playback</b>	<b>Record Mode</b>	Manual recording, timed recording, alarm recording	
		Priority of recordings: Manual recording > alarm recording > timed recording	
	<b>Recording time</b>	Recording file can be recorded from one minute to 120 minutes (adjustable, 60 minutes by default)	
	<b>Recording circulation manner</b>	Supports HDD circulation to overlap recordings	
	<b>Video search</b>	Query recordings by time, type, and channel number	
	<b>Playback modes</b>	Multiple slow playback, multiple fast playback, manual single-frame playback, reverse playback	
	<b>Multiple file switching modes</b>	Allows switching to the previous/next file of the currently played file, or any other file in the play list	
		Able to switch to any existing file of another channel at the same time of the current channel	
		Allows playing files continuously. After such play, the device continues playing the next file in the same channel	
	<b>Playback</b>	Supports single channel playback	
<b>Scaling</b>	The playback image can freely switch between suitable window size/full screen		
<b>Area zoom in</b>	In single image playback, you can select to enlarge any local area of the image		
<b>Storage</b>	<b>Backup method</b>	Able to connect with external USB storage devices (such as U disk)	
		Supports downloading via network and storage	
<b>GPS</b>	-	Works with built-in GPS Beidou dual-mode	
<b>Network function</b>	<b>Network control</b>	Remotely access front-end monitoring image	
		Access and set up system parameters through network client or browser	

Model		MXVR4104-4 (4 identification routes)	MXVR4104-8 (8 identification routes)
		Upgrade program and realize remote maintenance through the client or browser network	
		Allows for reviewing external alarms and video loss alarms through the network	
		Allows for downloading, storing, and playing back recording files	
		Supports building in 3G/4G modules that work with Telecom, Mobile, and Unicom. Built-in Wi-Fi optional	
Video loss and alarm	Video loss	Able to link with external alarm output or pop up prompts	
	External alarm	Able to link with recording, or link with external alarm output or pop up prompts	
	Manual alarm control	Can enable or disable an alarm input channel	
		Able to simulate and generate alarm signals to be exported to an alarm output channel	
	Alarm Input	10 routes of alarm input (you can select alarm types by enabling/disabling Always Open or Always Close)	
	Alarm Output	Four routes of controllable 12V alarm output	
Interface	USB interface	Two USB interfaces (one on the front panel, and one extended out of the rear panel through cable)	
	Network interface	RJ45 10M/100M self-adaptive Ethernet port (allows fixing cables)	
	RS485	1	
	CAN	Two CAN interfaces that require the support of custom programs	
	RS232	Four RS232 interfaces: One front DB9 interface, one used as a common serial port (debugging), two for service connection	
	VGA	Supports (custom optional cable), workable with purpose-made car-mounted touchscreen	
	Speed	One route of impulse speed input	
	Analog input	Two routes of analog input	
Information	HDD information	Display HDD usage and relevant information	
	Viewing Data Rate Information	Stream statistics and waveform display of each channel	
	Finding log	Displays system log and allows for finding log information by time and type	
	System status information	Displays vehicle status, voltage, ACC status, system version, and release date	
User	User	Multi-level user management	

Model		MXVR4104-4 (4 identification routes)	MXVR4104-8 (8 identification routes)
Management	Management	Multiple management modes that cover the collective management of local users, serial port users, and network users, and allows for setting up user permissions	
		Allows for adding users and groups and modifying permissions, without limiting the number of users and groups	
	Password security protection	Allows for modifying password. An authorized user can also set up passwords for other users.	
		Supports gesture password and retrieving Email password	
Program upgrade		Through WEB, client, or upgrade tools	
Log out or reboot		Login with password to ensure security	
		User-friendly menu dialog when closing the system menu: Provides the options of logging out or rebooting the system	
General parameter	Power supply	DC 6V-36V, built-in lithium battery, enables system protection in normal power cut-off and in under-voltage of vehicle accumulator	
	Power consumption	Bare unit (basic function) power consumption: ≤12W	
	Low power consumption	≤ 0.3W	
	Lithium battery	2600mAh 7.2V	
	Working temperature	-30℃ ~ +70℃	
	Working humidity	10% ~ 90%	
	Atmospheric pressure	86kPa~106kPa	
	Size	1DIN case Front panel: 189.3mm×60.2mm Frame: 179.6mm×159.8mm×50.0mm	
	Weight	Complete package: 2.3kg	
	Installation	Front installation, bracket installation	