



Dahua Network Speed Dome & PTZ Camera Web 3.0

User's Manual








Foreword

General

The manual introduces the functions and operations of the web interface of the network speed dome and PTZ camera (hereinafter referred to as "the Device").

Safety Instructions

The following categorized signal words with defined meaning might appear in the manual.

Signal Words	Meaning
 DANGER	Indicates a high potential hazard which, if not avoided, will result in death or serious injury.
 WARNING	Indicates a medium or low potential hazard which, if not avoided, could result in slight or moderate injury.
 CAUTION	Indicates a potential risk which, if not avoided, could result in property damage, data loss, lower performance, or unpredictable result.
 TIPS	Provides methods to help you solve a problem or save you time.
 NOTE	Provides additional information as the emphasis and supplement to the text.

Revision History

Version	Revision Content	Release Time
V3.0.1	Added Configuring User Group function.	July 2021
V3.0.0	<ul style="list-style-type: none"> Modified overlay, audio, network settings, and destination sections. Added Bluetooth settings, construction monitoring, battery exception, screen off settings, emergency maintenance, life statistics, and battery status sections. 	March 2021
V2.0.2	Added the note to provide international calling codes for 4G models.	June 2020
V2.0.1	Updated OSD info, TCP/IP and smart plan, and delete life statistics.	April 2020
V2.0.0	Added some functions of the Baseline, and refine the whole manual.	January 2020
V1.1.1	Updated some functions of the Security Baseline.	September 2019
V1.0.0	First release.	May 2018

About the Manual

- The manual is for reference only. If there is inconsistency between the manual and the actual product, the actual product shall prevail.

- We are not liable for any loss caused by the operations that do not comply with the manual.
- The manual would be updated according to the latest laws and regulations of related regions. For detailed information, see the paper manual, CD-ROM, QR code or our official website. If there is inconsistency between paper manual and the electronic version, the electronic version shall prevail.
- All the designs and software are subject to change without prior written notice. The product updates might cause some differences between the actual product and the manual. Please contact the customer service for the latest program and supplementary documentation.
- There still might be deviation in technical data, functions and operations description, or errors in print. If there is any doubt or dispute, please refer to our final explanation.
- Upgrade the reader software or try other mainstream reader software if the manual (in PDF format) cannot be opened.
- All trademarks, registered trademarks and the company names in the manual are the properties of their respective owners.
- Please visit our website, contact the supplier or customer service if there is any problem occurred when using the device.
- If there is any uncertainty or controversy, please refer to our final explanation.

Important Safeguards and Warnings

The manual will help you to use the Device properly. Read the manual carefully before using the Device, and keep it well for future reference.

Operation Requirements

- Avoid heavy stress, violent vibration, and water splash during transportation, storage, and installation. Complete package is necessary during the transportation. We assume no responsibility for any damage or problem caused by the incomplete package during the transportation.
- To avoid damage, protect the Device from falling down and heavy vibration. Arrange more than one person to move the Device when necessary.
- Buckle the safety hook before installing the Device if it is included.
- Keep the Device away from devices that generate electromagnetic field like televisions, radio transmitters, electromagnetic devices, electric machine, transformers, and speakers; otherwise image quality will be influenced.
- Keep the Device away from smoke, vapor, heat, and dust.
- Do not install the Device near heating furnace, spotlight, and other heat sources. If it is installed on ceiling, in kitchen or near boiler room, the Device temperature might rise.
- Do not disassemble the Device; otherwise it might cause dangers or device damage. Contact your local retailer or customer service center for internal setup or maintenance requirement.
- Make sure that there is no metal, or inflammable, explosive substance in the Device; otherwise it might cause fire, short-circuit, or other damage. Power off the Device and disconnect the power cord immediately if there is water or liquid falling into the Device. And contact your local retailer or customer service center. Avoid sea water or rain eroding the Device.
- Avoid aiming the lens at intense light source, including sunlight, and incandescent light; otherwise the lens might be damaged.
- For the Device that supports laser, do not aim the laser directly at eyes. And keep a proper distance from the flammable to avoid fire.
- Clean the enclosure with soft cloth. To remove the dirt, you can dip the soft cloth in proper detergent, wring it out, and then dry the enclosure with soft cloth. Do not use gasoline, paint thinner, or other chemicals to clean the enclosure; otherwise it might result in enclosure transfiguration or paint flake. Read all the manuals included before using chemical cloth. Avoid long time touch between the plastic or rubber material and the enclosure; otherwise it might result in device damage and paint flake.
- It is recommended that you use the Device with a lightning-proof device for better lightning-proof effect.
- Contact your local retailer or customer service center if the Device is abnormal. Do not disassemble or repair the Device by yourself. We assume no responsibility for any problems caused by unauthorized modifications, disassembly or repair, incorrect installation or use, and overuse of certain components.

Requirements for Installation and Maintenance Personnel

- Have certificates or experiences related to installation and maintenance of the closed-circuit television (CCTV), and have certificates related to working at height.
- Have basic knowledge and installation skills of CCTV system.
- Have basic knowledge and operation technique for low-voltage wiring and low-voltage electronic circuit connection.
- Have the ability to read and understand the manual.

Requirements for Lifting the Device

- Use secure lifting appliances suitable for the installation place and the product installation mode.
- Make sure that the selected tools reach the installation height and have high safety performance.

Power Requirements

- All installation and operations shall conform to local electrical safety regulations.
- The power supply must conform to the requirements of ES1 in IEC 62368-1 standard and be no higher than PS2. Note that the power supply requirements are subject to the device label.
- Use the power adapter recommended by the manufacturer.
- Do not connect several devices to one power adapter; otherwise it might result in overheat or fire if it exceeds the rated load.
- Make sure that the power is off when you connect the cables, install or uninstall the Device.
- Power off the Device and disconnect the power cord immediately if there is any smoke, disgusting smell, or noise from the Device. And contact your local retailer or customer service center.

Table of Contents

Foreword	I
Important Safeguards and Warnings.....	III
1 Network Configuration.....	1
1.1 Network Connection	1
1.2 Logging in to the Web Interface.....	1
1.2.1 Device Initialization.....	1
1.2.2 First-time Login	5
1.2.3 Device Login.....	7
1.2.4 Resetting Password	8
2 Live.....	11
2.1 Encoding Setting.....	11
2.2 Video Window Adjustment.....	12
2.3 System Menu.....	17
2.4 Video Window Functions.....	17
2.5 PTZ Configuration	21
2.6 PTZ Status.....	24
3 AI Live	26
3.1 AI Live Interface.....	26
3.1.1 Information Display Area of Detected Targets.....	26
3.1.2 Snapshot Display Area	27
3.1.3 Statistics Area of the Detected Targets	27
3.2 AI Live Settings	28
4 Playback.....	30
4.1 Video Playback	30
4.1.1 Video Play Function Bar	31
4.1.2 Recording Type	31
4.1.3 Auxiliary Functions.....	32
4.1.4 Video Playback File Search and Display Area.....	32
4.1.4.1 Download Files in Batches.....	33
4.1.4.2 Displaying File List	34
4.1.5 Video Clipping Area.....	36
4.1.6 Progress Bar Time Formats.....	36
4.2 Picture Playback.....	36
4.2.1 Picture Playing Functions.....	37
4.2.2 Picture Playback File Search and Display Area.....	37

4.2.3 Snapshot Types.....	39
5 Setting.....	40
5.1 Camera.....	40
5.1.1 Conditions Settings.....	40
5.1.1.1 Conditions.....	40
5.1.1.1.1 Picture.....	40
5.1.1.1.2 Exposure.....	42
5.1.1.1.3 Backlight.....	46
5.1.1.1.4 WB.....	46
5.1.1.1.5 Day & Night.....	47
5.1.1.1.6 Focus & Zoom.....	49
5.1.1.1.7 IR Light.....	50
5.1.1.1.8 Defog.....	54
5.1.1.2 Profile Management.....	56
5.1.2 Video.....	57
5.1.2.1 Video Stream.....	57
5.1.2.2 Snapshot.....	59
5.1.2.3 Overlay.....	60
5.1.2.3.1 Privacy Masking.....	60
5.1.2.3.2 Channel Title.....	61
5.1.2.3.3 Time Title.....	61
5.1.2.3.4 OSD Info.....	62
5.1.2.3.5 Font Attribute.....	64
5.1.2.3.6 Picture Overlay.....	64
5.1.2.3.7 Mobile State.....	65
5.1.2.3.8 Custom Overlay.....	66
5.1.2.3.9 Abnormal.....	66
5.1.2.3.10 Latitude and Longitude.....	67
5.1.2.4 ROI.....	67
5.1.2.5 Path.....	68
5.1.3 Audio.....	69
5.1.3.1 Configuring Audio Parameters.....	69
5.1.3.2 Configuring Alarm Audio.....	71
5.2 Network Settings.....	72
5.2.1 TCP/IP.....	72
5.2.1.1 An Example of Configuring IP Address with ARP/Ping.....	75
5.2.2 Port.....	75

5.2.3 PPPoE.....	77
5.2.4 DDNS.....	78
5.2.5 SMTP (Email).....	79
5.2.6 UPnP.....	82
5.2.7 Bonjour.....	83
5.2.8 SNMP.....	84
5.2.9 Multicast.....	87
5.2.9.1 RTP.....	87
5.2.9.2 TS.....	87
5.2.10 Auto Register.....	88
5.2.11 Wi-Fi.....	88
5.2.11.1 Wi-Fi Settings.....	88
5.2.11.2 WPS Settings.....	90
5.2.11.3 AP Settings.....	90
5.2.12 802.1x.....	91
5.2.13 QoS.....	92
5.2.14 4G/5G.....	92
5.2.14.1 Dialing Setting.....	93
5.2.14.2 Mobile Setting.....	94
5.2.15 Access Platform.....	96
5.2.15.1 P2P.....	96
5.2.15.2 ONVIF.....	97
5.2.15.3 RTMP.....	98
5.3 Bluetooth Settings.....	99
5.4 PTZ Settings.....	101
5.4.1 Protocol.....	101
5.4.1.1 Network PTZ Settings.....	101
5.4.1.2 Analog PTZ Settings.....	101
5.4.2 Function.....	102
5.4.2.1 Preset.....	102
5.4.2.1.1 Preset Settings.....	103
5.4.2.1.2 Special Preset Settings.....	104
5.4.2.2 Tour.....	104
5.4.2.3 Scan.....	105
5.4.2.4 Pattern.....	106
5.4.2.5 Pan.....	107
5.4.2.6 PTZ Speed.....	108

5.4.2.7 Idle Motion	109
5.4.2.8 PowerUp	109
5.4.2.9 PTZ Limit	110
5.4.2.10 Time Task	111
5.4.2.11 PTZ Restart	112
5.4.2.12 Default	112
5.5 Event Management	113
5.5.1 Video Detection	113
5.5.1.1 Motion Detection	113
5.5.1.2 Video Tamper	117
5.5.1.3 Scene Changing	118
5.5.2 Smart Motion Detection	119
5.5.3 Audio Detection	120
5.5.4 Smart Plan	122
5.5.5 IVS	124
5.5.5.1 Tripwire	125
5.5.5.2 Intrusion	127
5.5.5.3 Abandoned Object	128
5.5.5.4 Missing Object	130
5.5.6 Construction Monitoring	131
5.5.7 Face Recognition	137
5.5.7.1 Face Detection	137
5.5.7.2 Face Database Config	138
5.5.7.2.1 Adding Face Database	138
5.5.7.2.2 Adding Face Pictures	139
5.5.7.2.3 Managing Face Pictures	143
5.5.7.2.4 Face Modeling	144
5.5.7.3 Alarm Linkage	145
5.5.8 People Counting	146
5.5.8.1 People Counting Settings	146
5.5.8.2 Report	148
5.5.9 Heat Map	148
5.5.9.1 Heat Map Settings	148
5.5.9.2 Report	149
5.5.10 Video Metadata	150
5.5.10.1 Scene Setting	150
5.5.10.2 Picture Overlay	152

5.5.10.3 Report	153
5.5.11 Alarm	154
5.5.12 Abnormality	155
5.5.12.1 SD Card	155
5.5.12.2 Network Exception	157
5.5.12.3 Illegal Access	158
5.5.12.4 Security Exception	158
5.5.12.5 Battery Exception	159
5.6 Storage	160
5.6.1 Schedule	160
5.6.1.1 Record	160
5.6.1.2 Snapshot	161
5.6.1.3 Holiday Schedule	162
5.6.2 Snapshot by Location	163
5.6.3 Destination	164
5.6.3.1 Path	164
5.6.3.2 FTP	165
5.6.3.3 Local	166
5.6.3.4 NAS	167
5.6.4 Record Control	167
5.7 System Management	169
5.7.1 Device Settings	169
5.7.1.1 General	169
5.7.1.2 Date & Time	169
5.7.1.3 Screen Off Settings	171
5.7.2 Account Settings	171
5.7.2.1 Account	171
5.7.2.1.1 Username	171
5.7.2.1.2 Group Name	175
5.7.2.2 Onvif User	177
5.7.3 Safety	178
5.7.3.1 RTSP Authentication	178
5.7.3.2 System Service	178
5.7.3.3 HTTPS	180
5.7.3.4 Firewall	188
5.7.4 Peripheral	189
5.7.4.1 Wiper	189

5.7.5 Default.....	190
5.7.6 Import/Export.....	190
5.7.7 System Maintenance.....	191
5.7.7.1 Auto Maintain.....	191
5.7.7.2 Emergency Maintenance.....	192
5.7.8 Upgrade.....	192
5.8 Information.....	193
5.8.1 Version.....	193
5.8.2 Log Information.....	194
5.8.2.1 Log.....	194
5.8.2.2 Remote Log.....	195
5.8.3 Online User.....	196
5.8.4 Life Statistics.....	196
5.8.5 Battery Status.....	196
6 Alarm.....	198
7 Logout.....	200
Appendix 1 Cybersecurity Recommendations.....	201

1 Network Configuration

1.1 Network Connection

To view the web interface on your PC, connect the Device to the PC first. There are mainly two connection modes between the Device and PC.



The models presented in the figures are for reference only, and the actual product shall prevail.

Figure 1-1 Direct connection by using a network cable

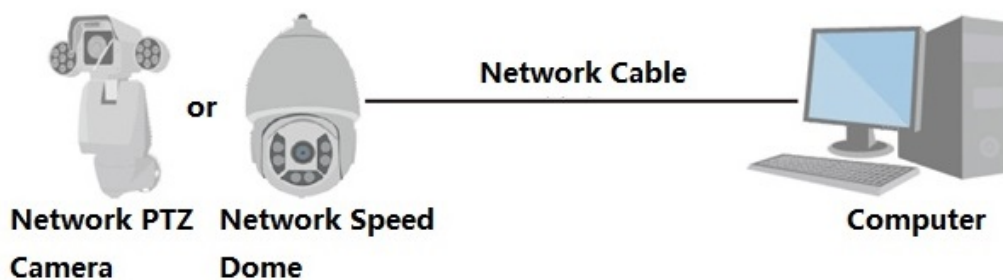
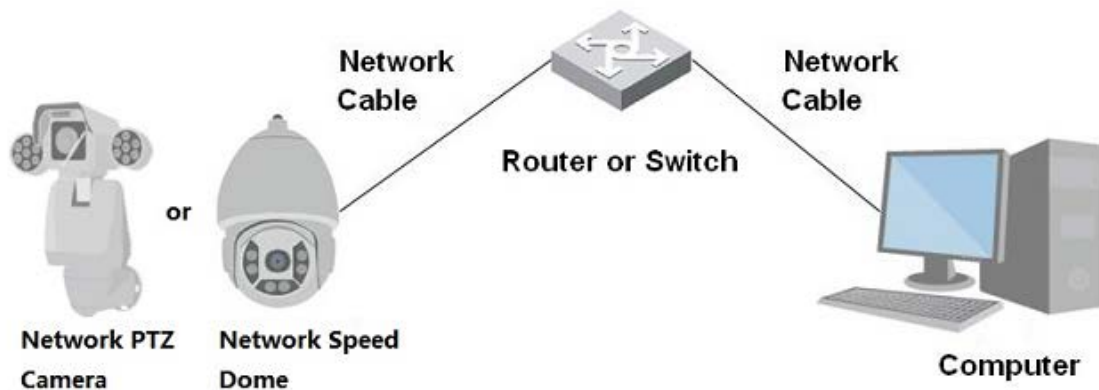


Figure 1-2 Connection by using a switch or router



All devices have the same IP address (192.168.1.108 by default) when they are delivered out of factory. To make the Device get access to network smoothly, plan available IP segment reasonably according to practical network environment.

1.2 Logging in to the Web Interface

1.2.1 Device Initialization

For first-time use or after you have restored the Device to defaults, you need to initialize the Device by performing the following steps.

Step 1 Open the browser, enter the IP address of the Device in the address bar, and then press the Enter key.

The **Country/Region Setting** interface is displayed. Set the **Country/Region**, **Language** and **Video Standard** as needed.

Figure 1-3 Country/region setting

The screenshot shows a web interface titled "Country/Region Setting". It contains three rows of settings, each with a label and a dropdown menu:

- Country/Region: Australia
- Language: English
- Video Standard: PAL

A "Save" button is positioned at the bottom center of the interface.

Step 2 Click **Save**, and the **Time Zone Setting** interface is displayed. Configure time parameters.

Figure 1-4 Time zone setting

The screenshot shows a web interface titled "Time Zone Setting". It contains the following elements:

- Date Format: YYYY-MM-DD
- Time Zone: (UTC+04:30) Kabul
- Current Time: 2019-02-27 13 : 51 : 36 (with a "Sync PC" button next to it)
- A red message: "It will be modified as 2019-02-27 10:21:36"
- A "Next" button at the bottom center.

Step 3 Click **Next**.

The **Device Initialization** interface is displayed. For the interface, see Figure 1-5. For the parameter description, see Table 1-1.

Figure 1-5 Device initialization

Device Initialization

Username: admin

Password:


Confirm Password:

Use a password that has 8 to 32 characters, it can be a combination of letter(s), number(s) and symbol(s) with at least two kinds of them. (please do not use special symbols like ' " ; : &)

Email Address

To reset password, please input properly or update in time.

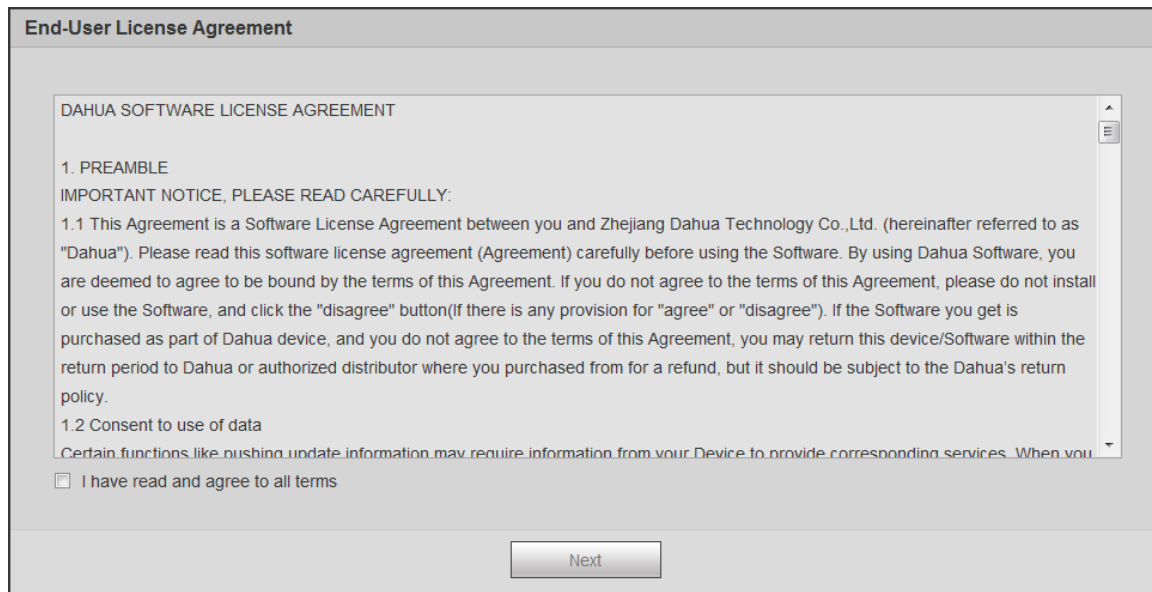
Table 1-1 Device initialization parameter description

Parameter	Description
Username	It is admin by default.
Password	The password should consist of 8 to 32 non-blank characters and contain at least two types of characters among upper case, lower case, number, and special characters (excluding ' " ; : &). Set a high security password according to the prompt of password strength. Make sure that the new password is the same as the confirming password.
Confirm Password	Enter the confirming password that shall be the same as the password you entered.
Email Address	Set the email address which is used to reset password.  Email address is enabled by default. You can disable the function as needed.

Step 4 Click **Save**.

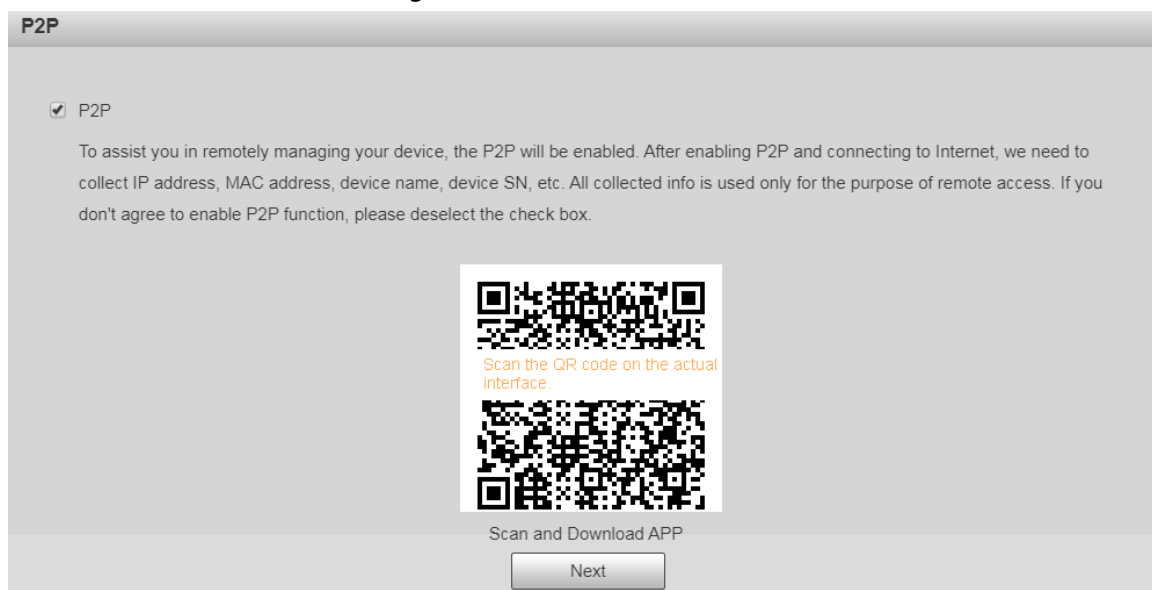
The **End-User License Agreement** interface is displayed.

Figure 1-6 End-user license agreement



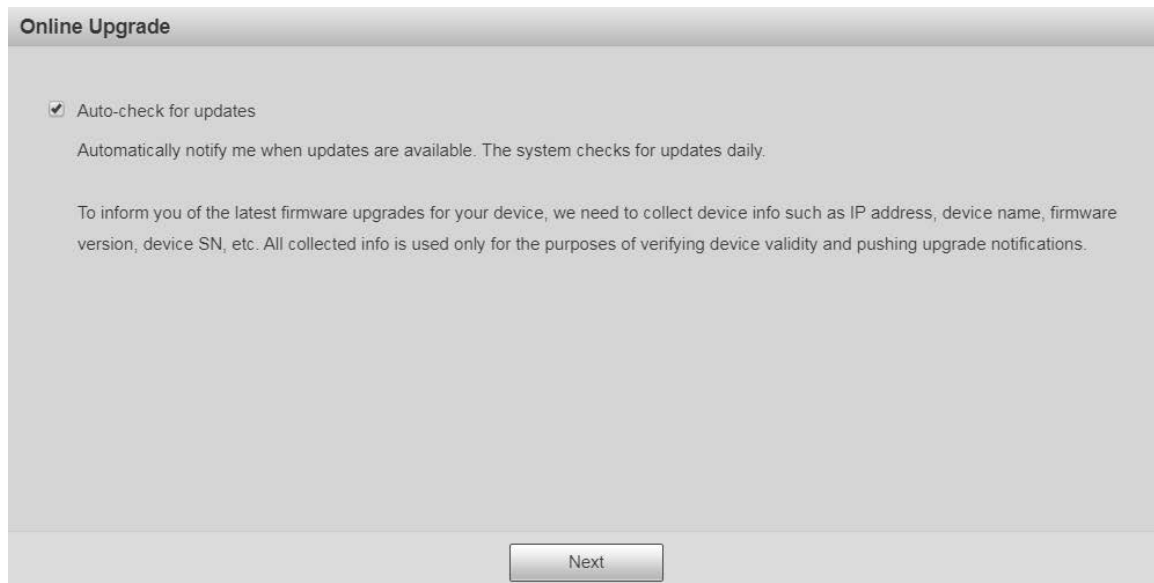
- Step 5** Select **I have read and agree to all terms** check box, and then click **Next**.
The **P2P** interface is displayed.

Figure 1-7 P2P interface



- Step 6** Scan the QR code on the interface, download the app, and then finish configurations according to the instructions on your mobile device. After that, click **Next**.
The **Online Upgrade** interface is displayed.

Figure 1-8 Online upgrade



- Step 7** Select **Auto-check for updates** check box as needed.
After the function is enabled, the Device will check for updates once a day automatically.
There will be system notice if any update is available.
- Step 8** Click **Next**, and the login interface is displayed.

Figure 1-9 Login interface



1.2.2 First-time Login

You need to download and install the plug-in for the first-time login.

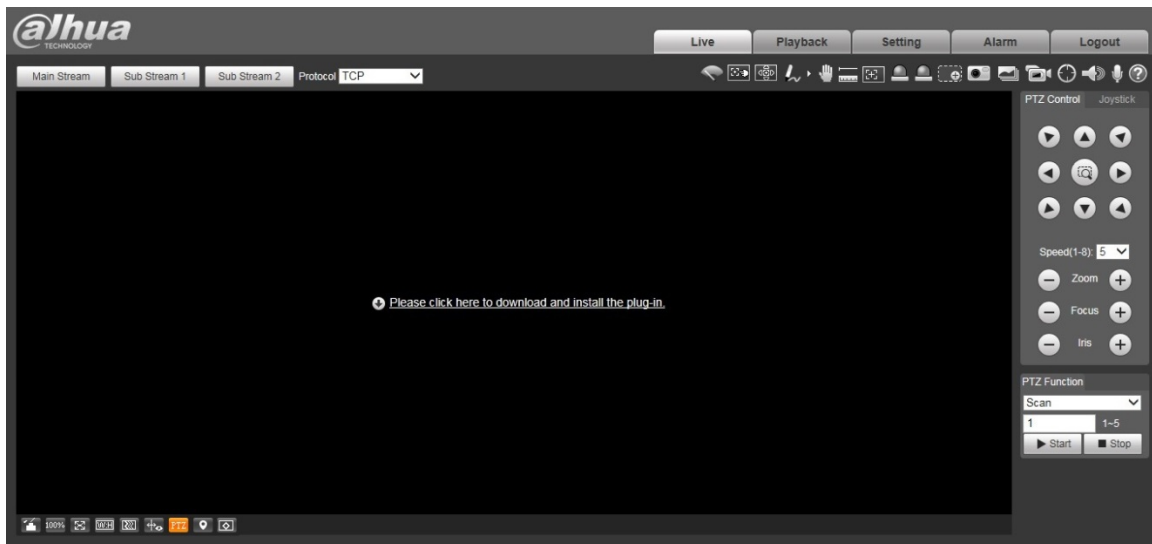
- Step 1** Open the browser, enter the IP address of the Device in the address bar, and then press Enter.
- Step 2** Enter the username and password, and then click **Login**.
The web interface is displayed.



- If you enter the wrong password for 5 times, the account will be locked for 5 minutes. After the locked time, you can log in to the web interface again.
- You can set the number of allowed password attempts and locked time in "5.5.12.3 Illegal Access".

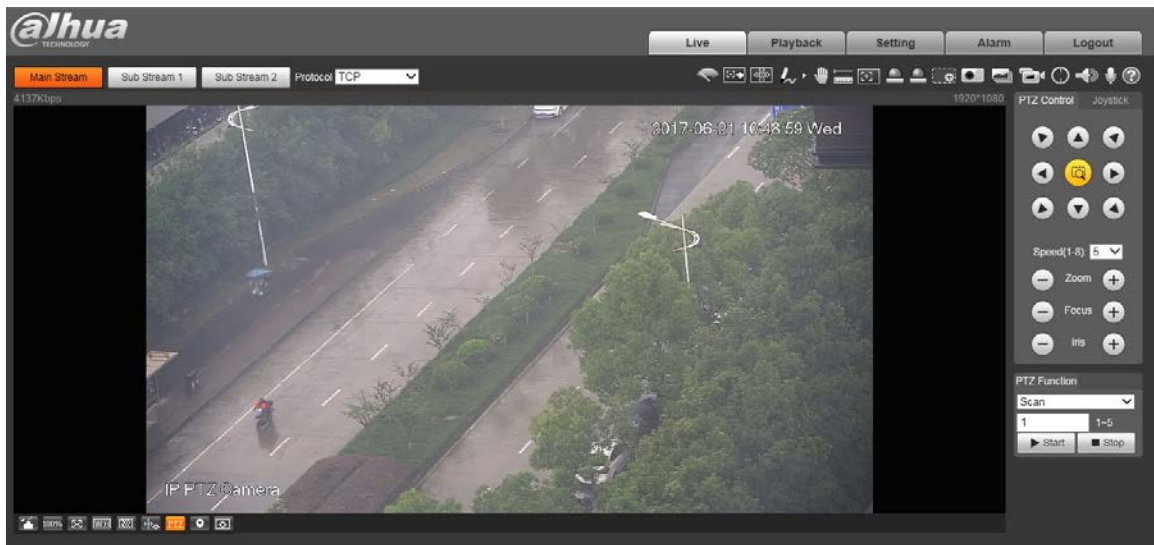
Step 3 Download and install the plug-in according to the on-screen instruction after logging in to the web interface.

Figure 1-10 Install the plug-in



Step 4 After the plug-in is installed, the web interface will be refreshed automatically, and the video is displayed on the **Live** interface.

Figure 1-11 Live interface



The **Live** interface shown in the manual is for reference only, and the actual interface shall prevail.

1.2.3 Device Login

Step 1 Open the browser, enter the IP address of the Device in the address bar, and then press Enter.

The **Login** interface is displayed.

Figure 1-12 Device login



Step 2 Enter the username and password, and then click **Login**.

The web interface is displayed, and the video is displayed on the **Live** interface.



- If you enter the wrong password for 5 times, the account will be locked for 5 minutes. After the locked time, you can log in to the web interface again.
- You can set the number of allowed password attempts and locked time. For details, see "5.5.12.3 Illegal Access".

1.2.4 Resetting Password

If you forget the password of the admin user, you can set the password through the provided email address.



Before resetting the password, you need to provide the email address in advance. For details, see "1.2.1 Device Initialization" or "5.7.3.2 System Service".

Step 1 Open the browser, enter the IP address of the Device in the address bar, and then press Enter.

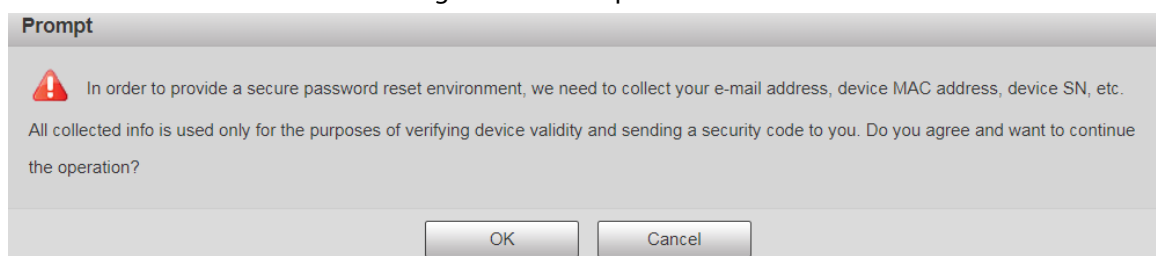
The **Login** interface is displayed.

Figure 1-13 Login



Step 2 Click **Forgot password?**, and the **Prompt** interface is displayed.

Figure 1-14 Prompt



Step 3 Click **OK** to reset the password.

The **Reset the password (1/2)** interface is displayed.



If you click **OK**, your email address, MAC address, device serial number, and other information might be collected.

Figure 1-15 Reset the password (1)

Reset the password(1/2)

SN: [redacted]

QR code:

Scan the QR code on the actual interface.

Note(For admin only):

Option 1. Please download DMSS and then from More-Reset Device Password, scan the left QR code.

Option 2. Please use an APP to scan the left QR code to get encryption strings. And then send the strings to support_rpwd@global.dahuatech.com.

The security code will be delivered to [redacted]

Security code:

Cancel Next

Step 4 Scan the QR code on the actual interface according to the instructions, and then enter the security code received in the mailbox.

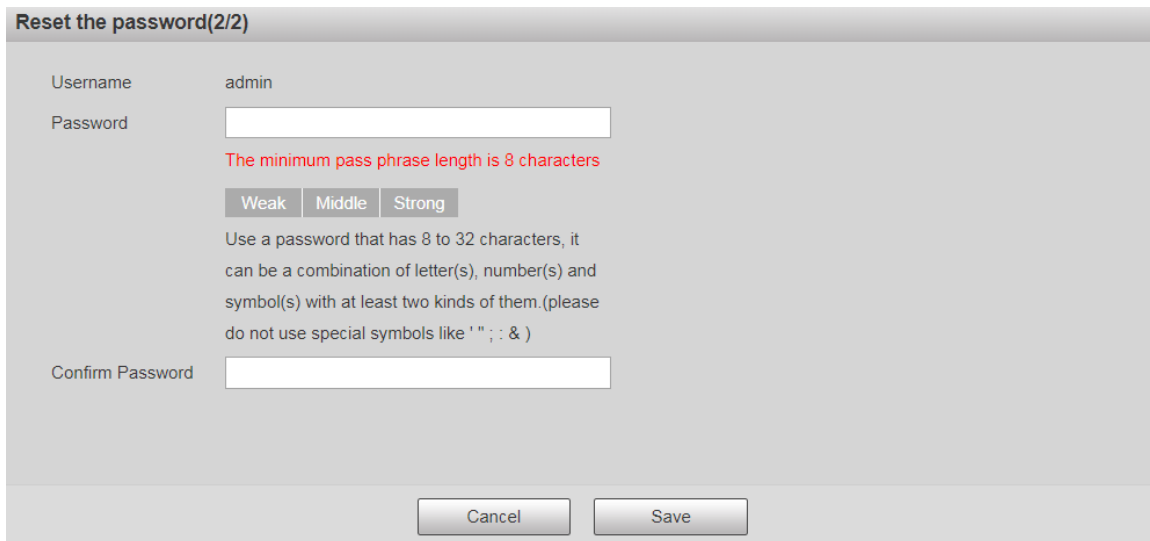


Reset the password with the security code you received within 24 hours, otherwise the code will be invalid.

Step 5 Click **Next**.

The **Reset the password (2/2)** interface is displayed.

Figure 1-16 Resetting the password (2)



Step 6 Set the password of the admin user again.



The password should consist of 8 to 32 non-blank characters and contain at least two types of characters among upper case, lower case, number, and special characters (excluding ' ' ; : &). Set a high security password according to the prompt of password strength.

Step 7 Click **Save**.

2 Live

Click the **Live** tab, and the **Live** interface is displayed.

Figure 2-1 Live interface

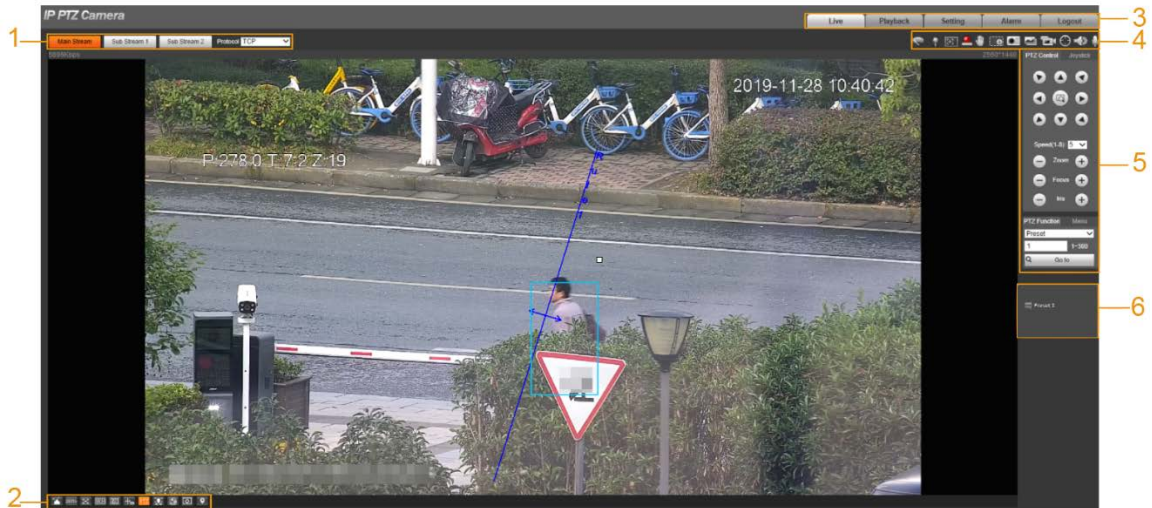


Table 2-1 Function bars description

No.	Description
1	Encoding setting
2	Video window adjustment
3	System menu
4	Video window functions
5	PTZ configuration
6	PTZ status

2.1 Encoding Setting



Some devices do not support two sub streams.

For the encoding setting area, see Figure 2-2. For the parameter description, see Table 2-2.

Figure 2-2 Encoding setting

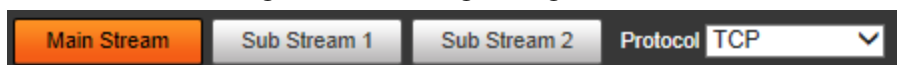


Table 2-2 Encoding setting parameter description

Parameter	Description
Main Stream	It has large bit stream value and image with high resolution, but requires large bandwidth. This option can be used for storage and monitoring.
Sub Stream 1	It has small bit stream value and smooth image, and requires little

Parameter	Description
Sub Stream 2	bandwidth. This option is normally used to replace main stream when bandwidth is not enough.
Protocol	Select a protocol for video monitoring. The supported protocols include TCP (Transmission Control Protocol), UDP (User Datagram Protocol), and Multicast .

2.2 Video Window Adjustment

For the video window adjustment bar, see Figure 2-3. For parameter description, see Table 2-3.

Figure 2-3 Video window adjustment

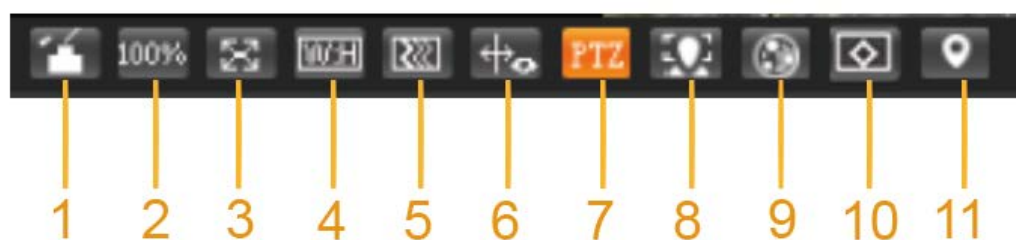


Table 2-3 Video window adjustment parameter description

No.	Parameter	Description
1	Image Adjustment	Click this button, and the Image Adjustment interface is displayed on the right side of the Live interface. You can adjust parameters such as brightness, contrast, hue, and saturation on the interface.
2	Original Size	Adjust the video image to original size.
3	Full Screen	Click this button, and the video is displayed in full screen. To exit full screen, double-click the screen or press the Esc key.
4	W:H	Adjust the video image to original ratio or a proper window.
5	Fluency	Click this button, and you can select Realtime , General , or Fluent . General is selected by default.
6	Rules Info	Click this button, and smart rules are displayed on the Live interface after the function is enabled. The function is enabled by default.
7	PTZ	Click this button, and PTZ configurations are displayed on the Live interface after the function is enabled.
8	Face	Click this button, and face pictures are displayed on the screen. See Figure 2-8.
9	Video Metadata	Click this button, and information about motor vehicles, non-motor vehicles, and people is displayed on the screen in real time. See Figure 2-11.
10	Anti-aliasing	Click this button to enable anti-aliasing, and then aliasing can be avoided when video windows are small.

No.	Parameter	Description
11	Panorama	Click this button, and a panorama window is displayed on the Live interface. You can perform operations such as positioning, calling presets, and setting tours.

Image Adjustment

For **Image Adjustment** interface, see Figure 2-4. For parameter description, see Table 2-4.

Figure 2-4 Image adjustment

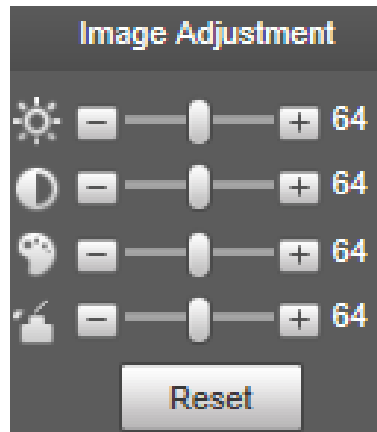




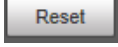


Table 2-4 Image adjustment parameter description

Parameter	Description
	Adjust the image brightness.
	Adjust the image contrast.
	Adjust the image hue.
	Adjust the image saturation.
	Restore brightness, contrast, saturation and hue to default values.



Only brightness, contrast, hue, and saturation of live view image on the web interface can be adjusted with this function. To adjust the brightness, contrast, hue, and saturation of the Device, you can go to **Setting > Camera > Conditions**.

Panorama

Figure 2-5 Panorama interface




- You can perform positioning in this window by drawing a box with the left mouse button. The located area is displayed on the **Live** interface and enlarged.
- After you click **Refresh**, the Device rotates from 0 to 360 degrees horizontally and from 6 to 65 degrees vertically to obtain a new panoramic image.
- You can adjust the size of the panoramic image by dragging the screen ratio bar .
- You can click **Preset** to call a corresponding preset on the right side of the window. For the interface, see Figure 2-6. For how to set a preset, see "5.4.2.1 Preset".

Figure 2-6 Preset



- You can click **Tour** to call a corresponding tour on the right side of the window. For the interface, see Figure 2-7. For how to set a tour, see "5.4.2.2 Tour".

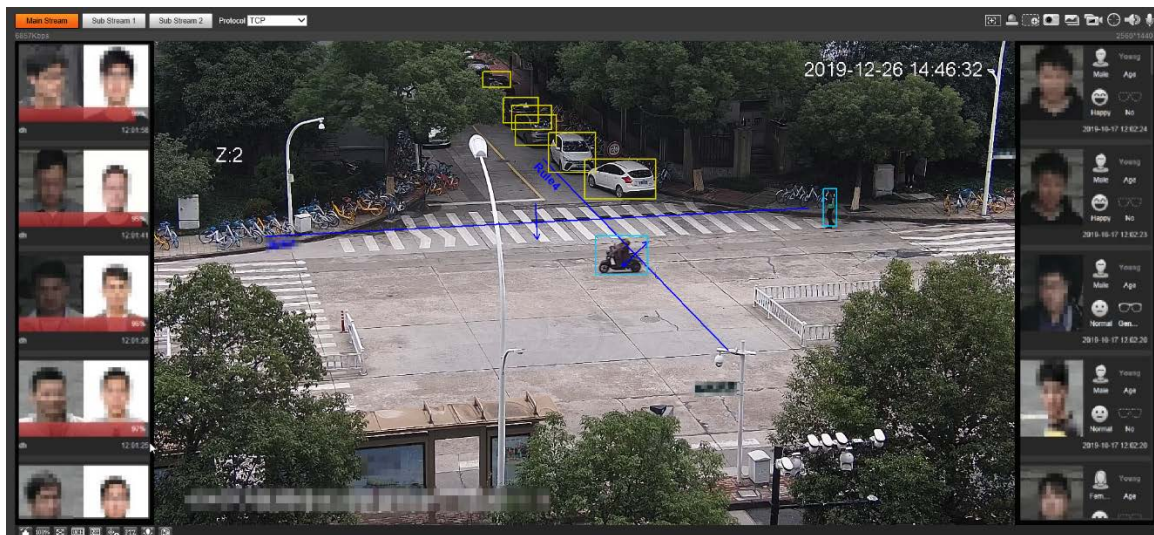
Figure 2-7 Tour



Face

For the **Face** interface, see Figure 2-8. Face recognition result is displayed on the left side, and the captured face picture and attributes are displayed on the right side.

Figure 2-8 Face



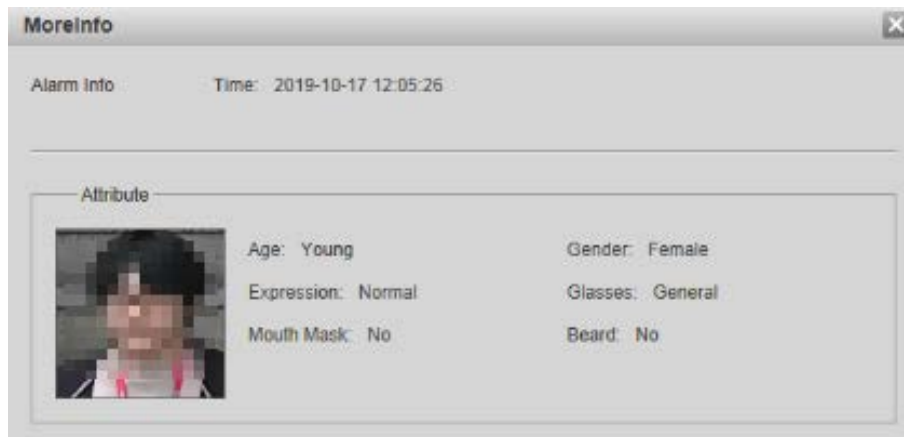
- Face recognition result display area: Displays the captured small face pictures, the corresponding face pictures in the database, and the similarities between them. After you click the picture, the attributes and details are displayed.

Figure 2-9 Face recognition result display



- Face and attributes display area: Displays the captured small face pictures and information such as gender, age, and expression. After you click the picture, the details are displayed.

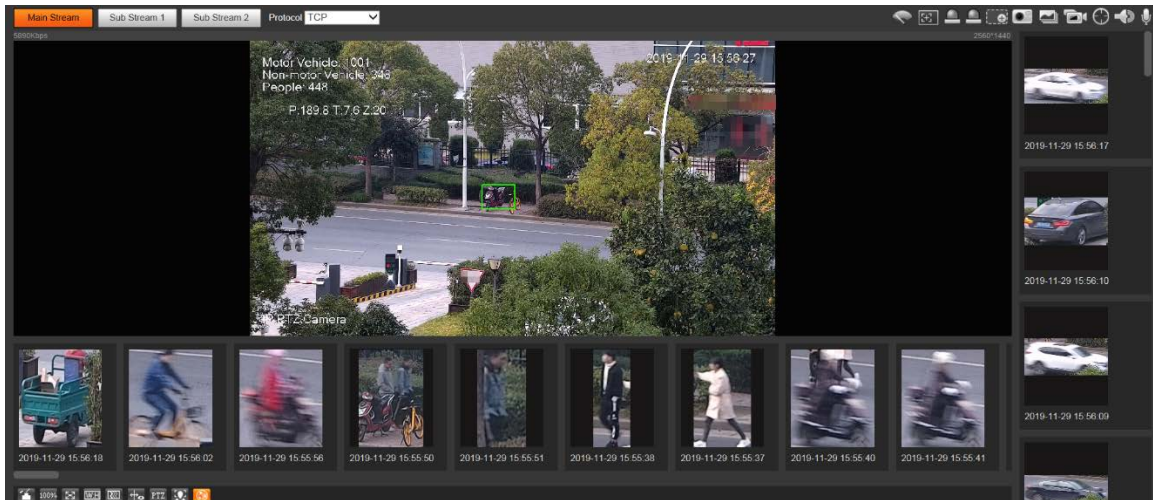
Figure 2-10 Face and attributes display



Video Metadata

For the interface, see Figure 2-11. Motor vehicle information is displayed on the right side, and the information about human and non-motor vehicles is at the bottom of the interface. For more details, see "5.5.10 Video Metadata".

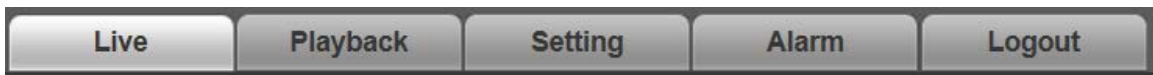
Figure 2-11 Video metadata



2.3 System Menu

To access an interface, click the corresponding tab on the system menu.

Figure 2-12 System menu



2.4 Video Window Functions

For the video window function buttons, see Figure 2-13. For the parameter description, see Table 2-5.

Figure 2-13 Video window function buttons

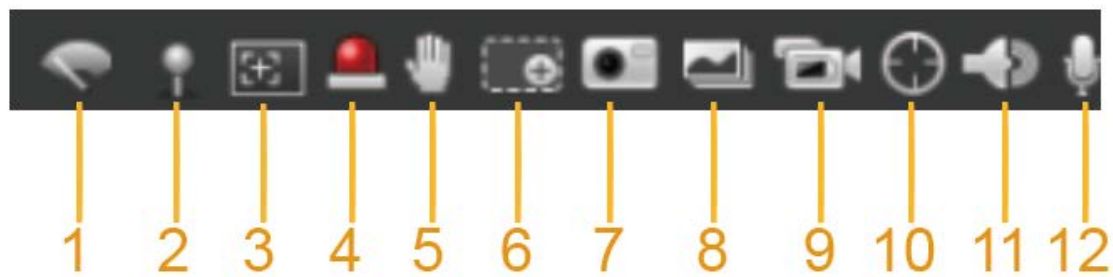


Table 2-5 Video window function button description

No.	Parameter	Description
1	Wiper Control	Click this button to select wiper operation. <ul style="list-style-type: none"> • Start: Click this button, and the wiper starts and waves continuously. • Stop: Click this button, and the wiper is turned off and stops waving. • Once: Click this button, and the wiper starts and waves from left to right for one time.
2	Mark	Click this button, right-click on the Live interface, and the function menu is displayed. See Figure 2-14. You can add information on the Live interface, and also manage added comments. <ul style="list-style-type: none"> • Add info: Select Add Info from the pop-up menu, and enter the comment. For the interface, see Figure 2-15. • Manage comments: Select Info Management from the pop-up menu to display, hide, or delete added comments. For the interface, see Figure 2-16.
3	Regional Focus	Click the button, draw a box with the mouse on the live view, and then the Device will automatically focus on the area in the box.
4	Relay-out	Click the button, and an alarm will be triggered. When an alarm is triggered, the icon turns red; and when an alarm is canceled, the icon turns grey.
5	Gesture Control	Click the button, and you can drag the live view by pressing and holding the left mouse button to control PTZ; and you can also zoom in or out through the mouse wheel.
6	Digital Zoom	<ul style="list-style-type: none"> • Click the button, and then select an area in the live view to zoom in; right-click on the image to restore to the original status. In enlarged status, drag the image to check other area. • Click the button, and then scroll the mouse wheel in the live view to zoom in or out.
7	Snapshot	Click the button to capture one picture of the current image, and it will be saved to the live snapshot storage path set in "5.1.2.5 Path."


No.	Parameter	Description
8	Triple Snapshot	Click the button, and three pictures of the current image are captured with one snapshot per second. These snapshots will be saved to the live snapshot storage path set in "5.1.2.5 Path."
9	Record	Click the button to record videos. The recording will be saved to the live recording storage path set in "5.1.2.5 Path."
10	Manual Track	Click the button and select any area by dragging the left mouse button in the video window; the Device tracks objects in this area intelligently.
11	Audio	<p>Click the button to enable or disable audio output of the monitoring stream.</p>  <p>Before using the function, you need to enable the audio of the corresponding stream in Setting > Camera > Audio first.</p>
12	Talk	Click the button to enable or disable the two-way audio.

Figure 2-14 Mark—menu

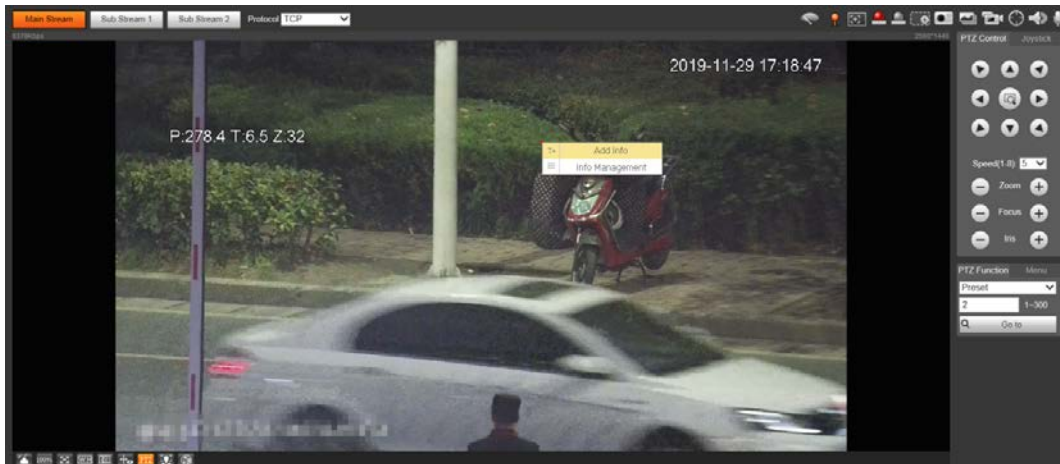
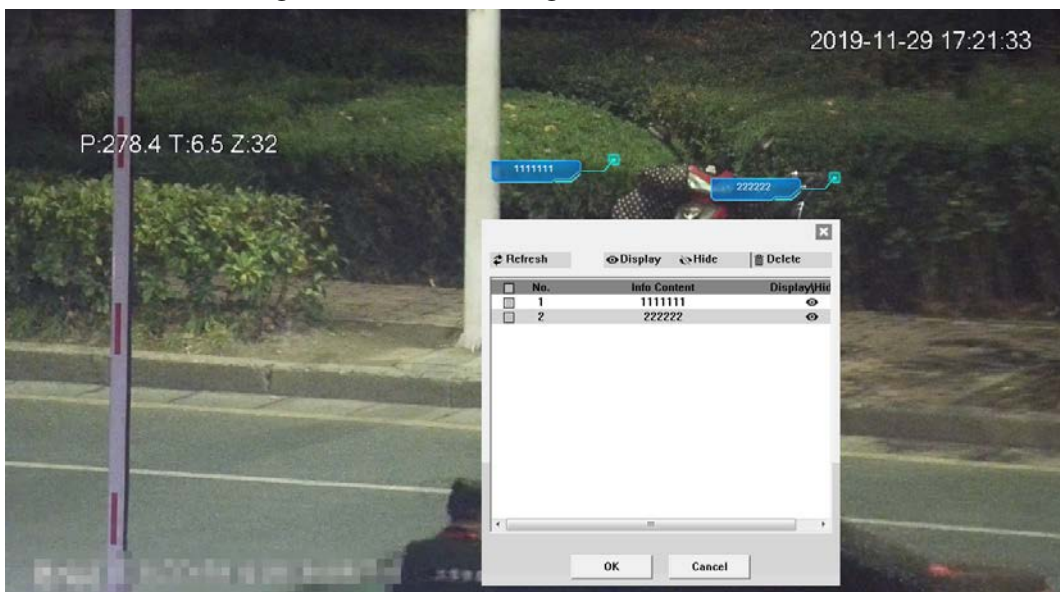


Figure 2-15 Mark—add comments



Figure 2-16 Mark—manage comments



2.5 PTZ Configuration

You can control PTZ by using the **PTZ Control** panel or joystick. You can also set preset, scanning, and other functions in the **PTZ Function** area.

PTZ Control



Before using the **PTZ Control** panel, you need to set the PTZ protocol by selecting **Setting > PTZ > Protocol**.

For **PTZ Control** panel, see Figure 2-17. For parameter description, see Table 2-6.

Figure 2-17 PTZ control

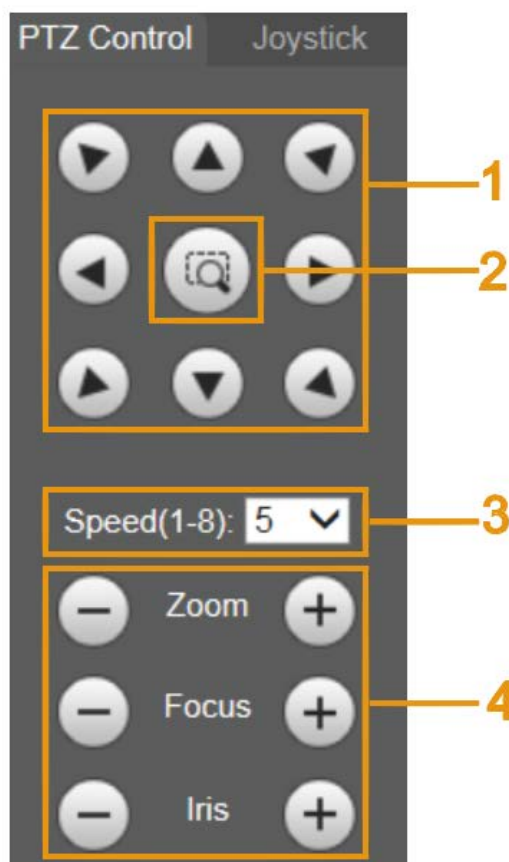




Table 2-6 PTZ control parameter description

No.	Parameter	Description
1	Direction Buttons	There are 8 directions: Up, down, left, right, upper left, upper right, lower left, and lower right.
2	Position	Provides quick positioning function. Draw a box in the live view with the mouse, and then the PTZ rotates to and focuses on the selected area rapidly.
3	Speed	The changing speed of PTZ direction. The higher the value, the faster the speed.

No.	Parameter	Description
4	Zoom/Focus/Iris	Click  to increase the value, and click  to decrease the value.

Joystick

You can drag the middle button to simulate joystick operations to control device rotation. For the operation interface, see Figure 2-18. Speed, zoom, focus, and iris configurations are the same as that of **PTZ Control** panel.

Figure 2-18 Joystick



PTZ Functions


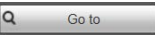

The PTZ supports multiple functions. Select a function, click  or  to start using the function, and then click  to stop using the function. For the configuration interface, see Figure 2-19. For the supported functions and settings, see Table 2-7.

Figure 2-19 PTZ functions

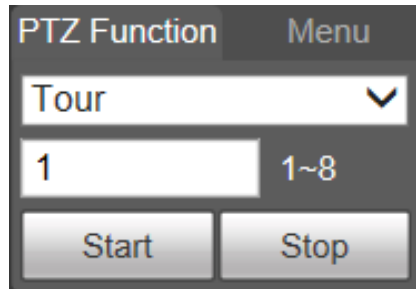



Table 2-7 PTZ functions description

Parameter	Description
Scan	Select Scan from the list, enter a scan number, and then click Start . The PTZ starts scanning, and the default number is 1.
Preset	Select Preset from the list, enter a preset number, and then click Go to . The PTZ will rotate to the preset position.
Tour	Select Tour from the list, enter a tour number, and then click Start . The PTZ starts to tour.
Pattern	Select Pattern from the list, enter a pattern number, and then click Start . The PTZ starts to pattern.
Assistant	Reserved for special requirements.  If necessary, enable this function under the guidance of professionals.
Pan	Select Pan from the list, and then click Start . The PTZ starts to pan.
Go to	<ul style="list-style-type: none"> Select Go to from the list, enter horizontal angle value, vertical angle value and zoom, and then click Go to. The Device will turn to the position you want. One unit of the horizontal angle value or vertical angle value you enter equals 0.1 degree.

Menu

For the menu interface, see Figure 2-20. For the parameter description, see Table 2-8.

Figure 2-20 Menu interface

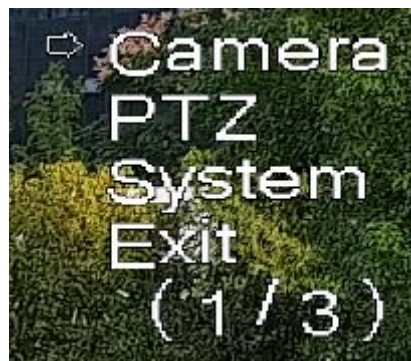


Table 2-8 Menu parameter description

Parameter	Description
Direction Buttons	Click the up and down buttons to select parameters, and click the left and right buttons to select parameter values.
OK	Confirmation button.
Open	Open the OSD menu.
Close	Close the OSD menu.

Click **Open** to open the OSD menu. The OSD menu is displayed on the live view.

Figure 2-21 OSD menu



You can finish the following settings through the menu.

- Camera settings: For details, see "5.1 Camera".
- PTZ settings: For details, see "5.4 PTZ Settings".
- System management: For details, see "5.7 System Management".

2.6 PTZ Status

On the **Live** interface, the PTZ status is displayed at the lower right corner.



The function is available on select models.

Figure 2-22 PTZ status



When the PTZ lifespan is close to the threshold, a warning will be displayed on the **Live** interface.

Figure 2-23 Warning (1)

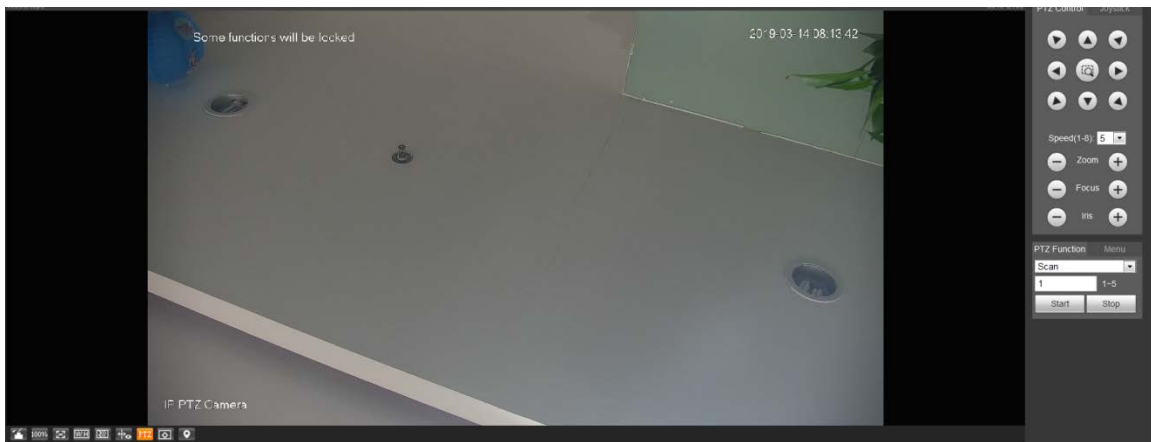


Figure 2-24 Warning (2)



3 AI Live

You can check the information of the detected human faces, human bodies, motor vehicles, and non-motor vehicles.



This function is available on select models.

3.1 AI Live Interface

For the **AI Live** interface, see Figure 3-1. For the layout description, see Table 3-1.

Figure 3-1 AI live interface

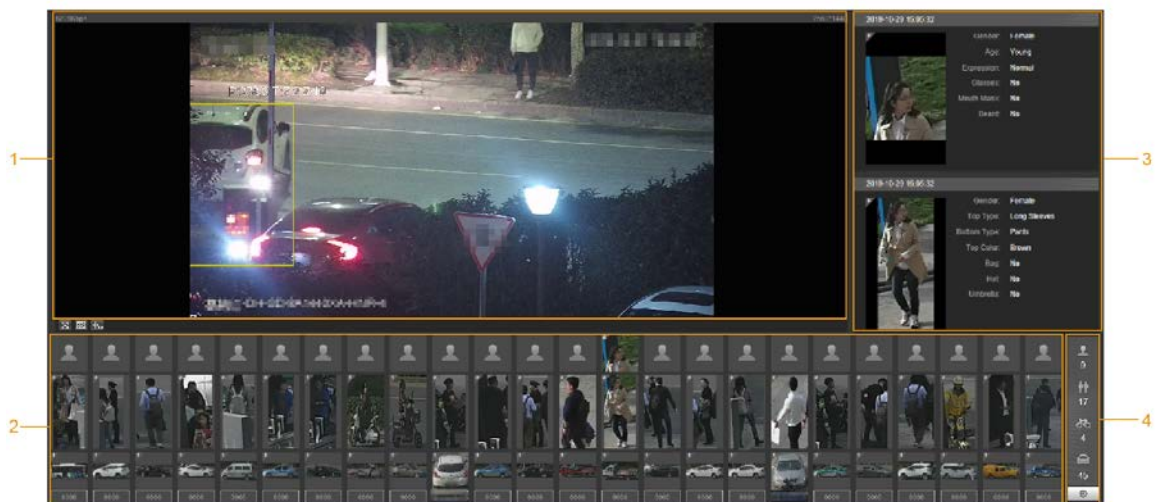


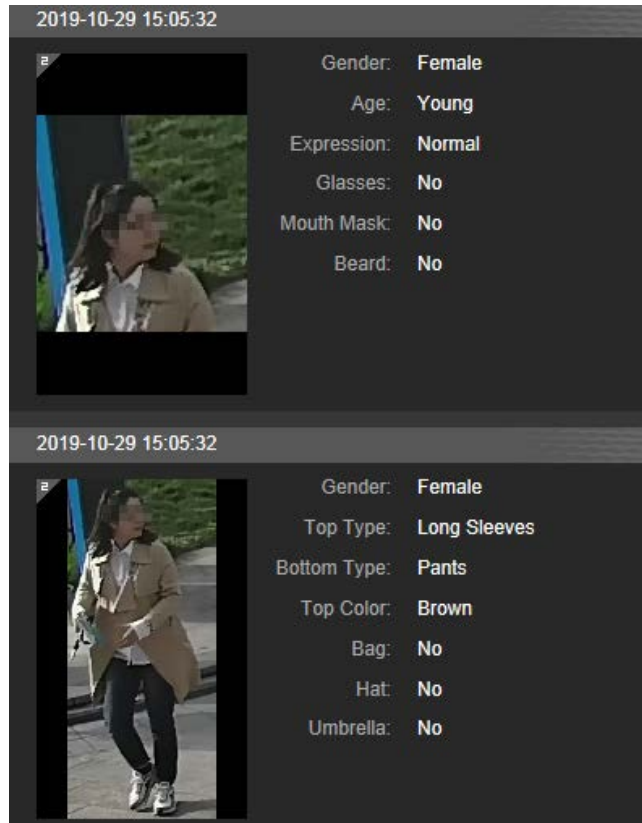
Table 3-1 AI live interface description

No.	Function
1	Live view
2	Snapshot display area
3	Information display area of detected targets
4	Statistics area of the detected targets

3.1.1 Information Display Area of Detected Targets

This area displays the information of the captured targets in real time.

Figure 3-2 Information display of the detected targets



3.1.2 Snapshot Display Area

This area displays the snapshots of the detected targets. Click any snapshot to view the information of the detected target in information display area.

Figure 3-3 Snapshot display area



3.1.3 Statistics Area of the Detected Targets

This area displays the number of the captured target in real time.

Figure 3-4 Statistics area of the detected targets



Table 3-2 Statistics area description of the detected targets

Icon	Detected Target	Description
	Face	Available detection items: Gender, age, expression, glasses, mouth mask, and beard.
	Human	Available detection items: Top, bottom, top color, bottom color, bag, hat, and umbrella.
	Non-motor vehicle	Available detection items: Vehicle type, vehicle body color, top, top color, occupancy, and hat.
	Motor vehicle	Available detection items: License plate, vehicle body color, vehicle type, vehicle logo, vehicle series, sunshield, seatbelt, smoking, calling, ornament, and annual inspection mark. Up to 7 items can be selected at the same time for motor vehicle detection.
	Settings	Click the button to select the detection items.

3.2 AI Live Settings

Prerequisites

Select **Setting** > **Event** > **Smart Plan**, and then enable **Face Detection**, **Face Recognition** or **Video Metadata**.

For the method to enable the function, see "5.5.4 Smart Plan". For the operations, see "5.5.7 Face Recognition" or "5.5.10 Video Metadata".

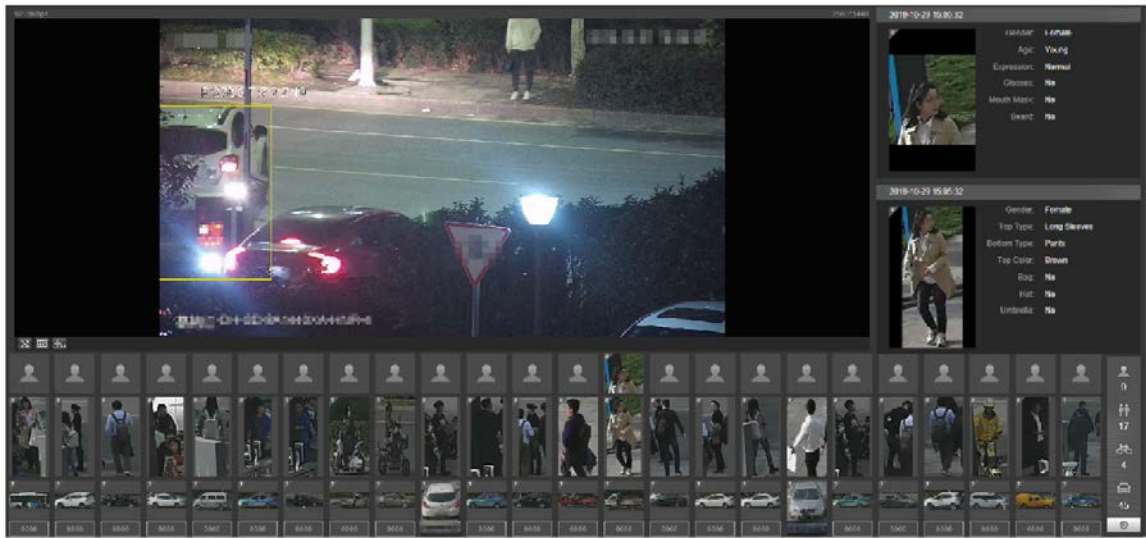
Procedure

Step 1 Click the **AI Live** tab.

The **AI Live** interface is displayed. See Figure 3-5. The information display area of detected

targets is on the right side; the snapshot display area is on the bottom; the statistics area of the detected targets is on the lower right corner.

Figure 3-5 AI live interface




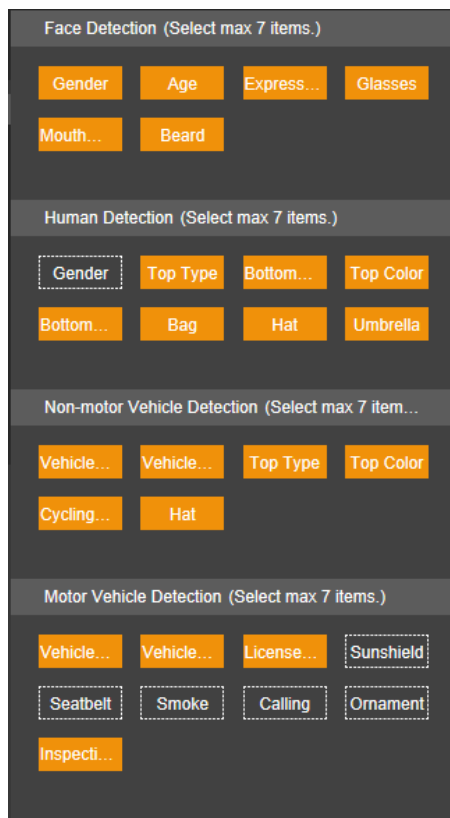

Step 2 Click  to set the detection items of the targets.

Figure 3-6 Detection items selection interface



Step 3 Click  to complete the configuration.

4 Playback

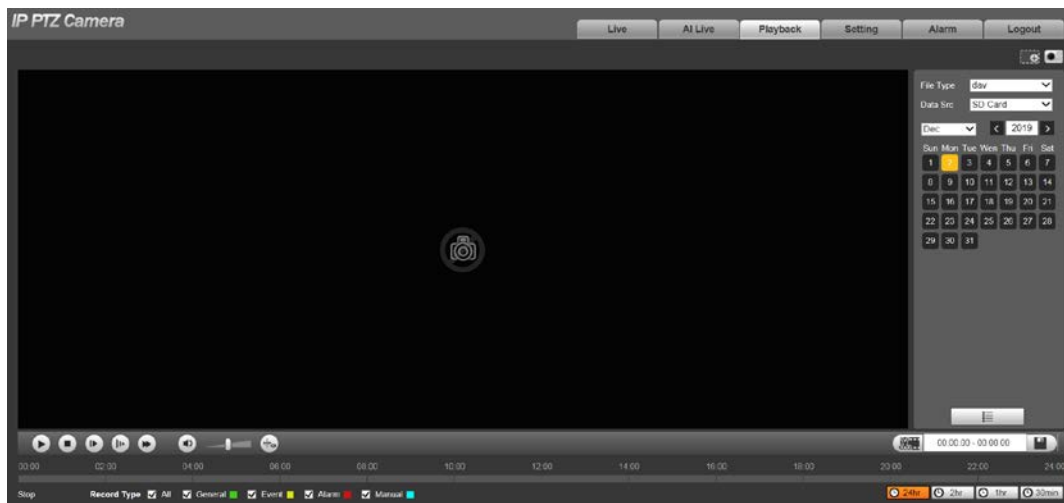
You can view the saved pictures and videos on the **Playback** interface.



Before using the function, you need to set the period, storage method, and record control of recording and snapshot first. For details, see "5.6 Storage".

Click the **Playback** tab, and the **Playback** interface is displayed.

Figure 4-1 Playback interface



4.1 Video Playback

Select **dav** from the **File Type** list, and the video playback interface is displayed. See Figure 4-2. For parameter description, see Table 4-1.

Figure 4-2 Video playback

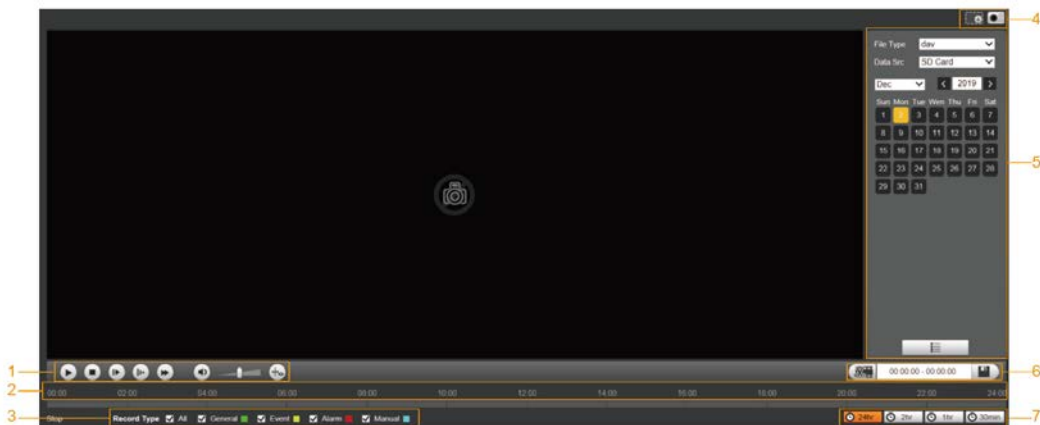


Table 4-1 Video playback parameter description

No.	Description
1	Video playing function bar

No.	Description
2	Progress bar
3	Recording types
4	Auxiliary functions
5	Video playback file search and display area
6	Video clipping area
7	Progress bar time formats

4.1.1 Video Play Function Bar

For the video playing function bar, see Figure 4-3. For the parameter description, see Table 4-2.

Figure 4-3 Video playing function bar

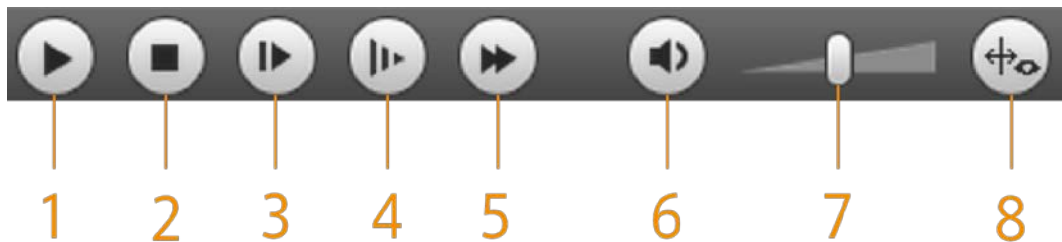



Table 4-2 Video play function bar description

No.	Parameter	Description
1	Play	Play the video.
2	Stop	Stop playing the video.
3	Next Frame	Play the next frame.  You need to pause the playback before playing the next frame.
4	Slow	Slow down video playing.
5	Fast	Speed up video playing.
6	Sound	Mute or unmute the sound.
7	Volume	Adjust the volume.
8	Rules Info	Click this button, and smart rules will be displayed on the video playback interface if the smart rules are enabled.

4.1.2 Recording Type

Select a recording type, and then only files of the selected types will be displayed in the progress bar and file list.

Figure 4-4 Recording type



4.1.3 Auxiliary Functions

For the auxiliary functions, see Figure 4-5. For the parameter description, see Table 4-3.

Figure 4-5 Auxiliary functions



Table 4-3 Auxiliary functions parameter description

No.	Parameter	Description
1	Digital Zoom	<ul style="list-style-type: none"> Click the button, and then select an area in the live view to zoom in; right-click on the image to restore to the original status. In zoomed-in status, drag the image to check other areas. Click the button, and then scroll the mouse wheel in the live view to zoom in or out.
2	Snapshot	Click the button, and then you can take snapshots of the video in playback, and save them in the playback snapshot path set in "5.1.2.5 Path".

4.1.4 Video Playback File Search and Display Area

There are videos and snapshots on days with blue shading. See Figure 4-6. For the parameter description, see Table 4-4.

Figure 4-6 Playback file (1)

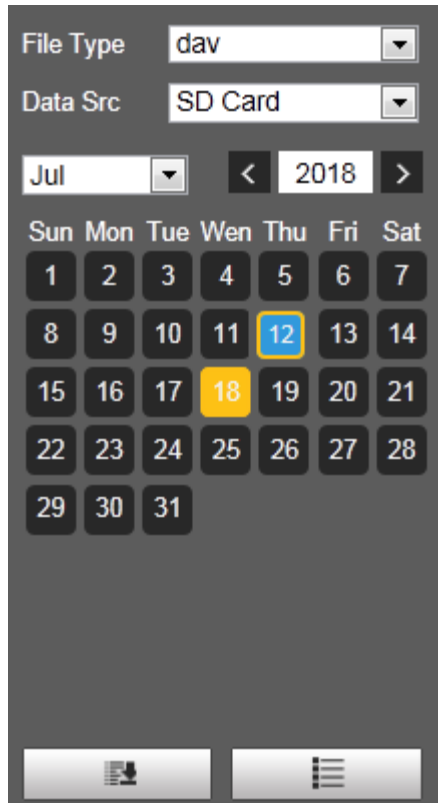





Table 4-4 Playback file parameter description (1)

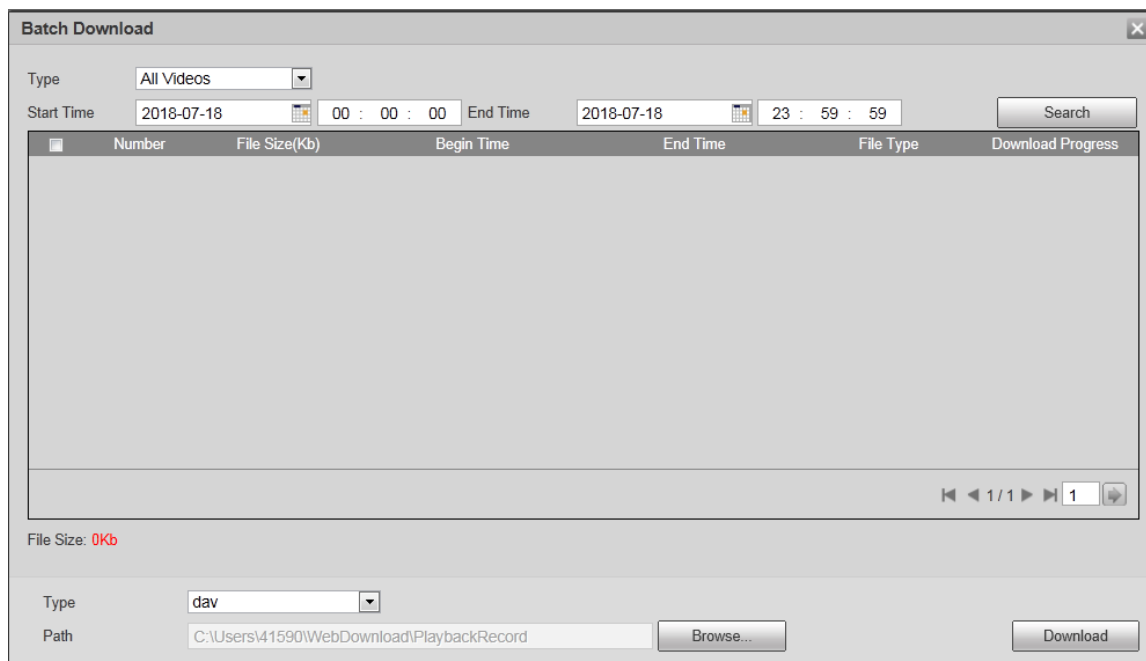
Parameter	Description
File Type	<ul style="list-style-type: none"> To play back a recording, select dav. To play back a picture, select jpg.
Data Src	The SD Card is used by default.
	<p>Click this button, and recordings or pictures of a certain type on specific dates can be downloaded in batches.</p> <p></p> <p>The function is available on select models.</p>
	File list. Click this button, and the recording files on the selected day will be displayed in the list.

4.1.4.1 Download Files in Batches

Step 1 Click .

The **Batch Download** interface is displayed.

Figure 4-7 Batch download



Step 2 Configure parameters as needed.

Table 4-5 Batch download parameters description

Parameter	Description
Type	Select the event type that triggers video recording. All Videos, General, Event, Alarm, Manual, and Snapshot are selectable. It is All Videos by default.
Start Time/End Time	Select the start time and end time for video searching.
File Type	Select the video type. dav and mp4 are selectable. It is dav by default.
Path	Click Browse , and set the saving path for video files. The default path is C:\Users\admin\WebDownload\PlaybackRecord.

Step 3 Click **Search** to search for the video files that meets the requirements.

Step 4 Select the video, and then click **Download**.

The video files are downloaded and saved in the saving path.



You can select multiple files to download them.

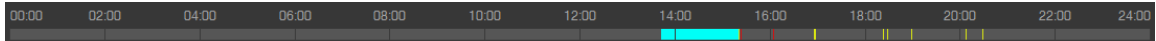
4.1.4.2 Displaying File List


Step 1 Click a day with blue shading, and recording file progress bar with different colors is displayed on the time axis.

- Green: Represents general videos.
- Yellow: Represents motion detection videos.
- Red: Represents alarm videos.
- Blue: Represents manually recorded videos.

Step 2 Click anywhere on the progress bar, and the video will be played from that time.

Figure 4-8 Progress bar



Step 3 Click , and videos recorded on the selected day will be displayed in a list. For the playback file list, see Figure 4-9. For the parameter description, see Table 4-6.



To play back a file in the list, double-click the file.

Figure 4-9 Playback file (2)

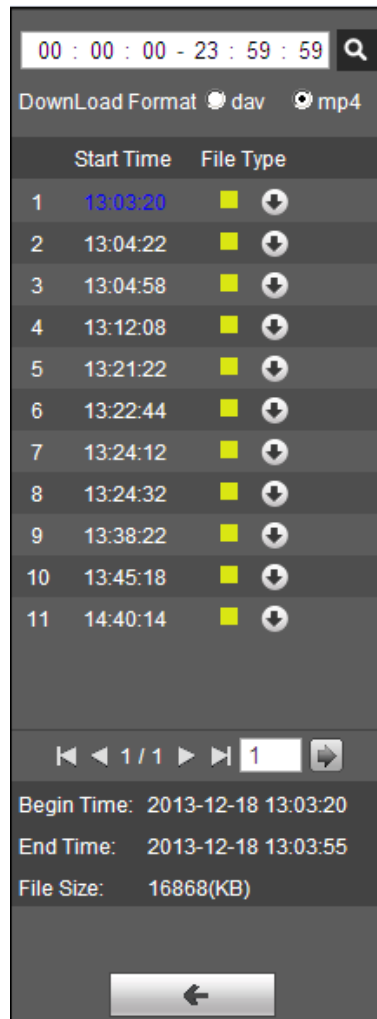






Table 4-6 Playback file parameter description (2)

Parameter	Description
	Search all the recorded files from the start time to the end time on the selected date.
Download Format	There are two options: dav and mp4 .
	Click the download button, and the files will be saved to the storage path set in "5.1.2.5 Path".  Downloading and playing video at the same time is not supported.
	Click the button to go back to the calendar interface.


4.1.5 Video Clipping Area


You can clip the videos in this area.

Figure 4-10 Video clipping



Step 1 Click the time axis to select the start time for video clipping. The time must be within the progress bar range.


Step 2 Hover over , and then **Select start time** is displayed.


Step 3 Click  to set the start time for video clipping.


Step 4 Click the time axis to select the end time for video clipping.



The time must be within the progress bar range.

Step 5 Hover over , and then **Select end time** is displayed.

Step 6 Click  to set the end time for video clipping.

Step 7 Click , and the clipped video will be saved in the path set in "5.1.2.5 Path".




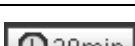
4.1.6 Progress Bar Time Formats

For the progress bar time format, see Figure 4-11. For the parameter description, see Table 4-7.

Figure 4-11 Progress bar time formats



Table 4-7 Progress bar time format description

Parameter	Description
	Click the button, and then the progress bar displays the recordings in 24-hour mode.
	Click the button, and then the video within the selected 2-hour period is displayed.
	Click the button, and then the video within the selected 1-hour period is displayed.
	Click the button, and then the video within the selected 30-minute period is displayed.

4.2 Picture Playback

Select **jpg** from the **File Type** list. For the picture playback interface, see Figure 4-12. For the parameter description, see Table 4-8.

Figure 4-12 Picture playback

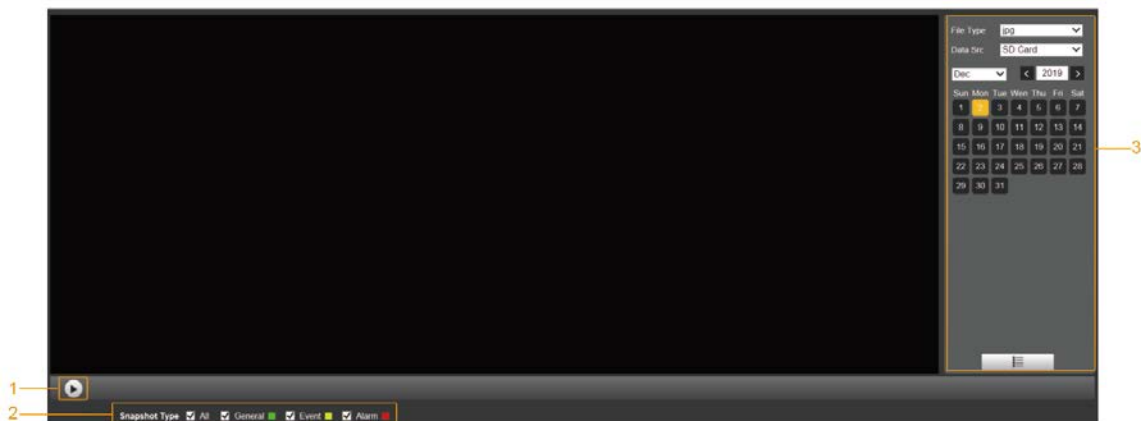


Table 4-8 Picture playback parameter description


No.	Description
1	Picture playing functions
2	Snapshot types
3	Picture playback file search and display area




4.2.1 Picture Playing Functions

For the picture playing buttons, see Figure 4-13.

Figure 4-13 Picture playing buttons



The status button is displayed as  by default, indicating the picture play is paused or no picture is being played.

- To play the picture, click , and the button is switched to .
- To pause the picture play, click .

4.2.2 Picture Playback File Search and Display Area

For the playback file interface, see Figure 4-14 and Figure 4-15. For the description of buttons on the interface, see Table 4-9.

Figure 4-14 Playback file (1)

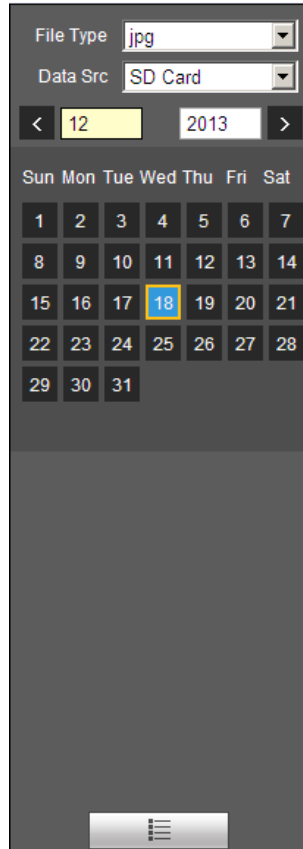


Table 4-9 Button description



Parameter	Description
File Type	Select jpg from the File Type list, and the picture will be played if any.
Data Src	The SD Card is selected by default.
	File list. Click this button, and the recording files on the selected day will be displayed in the list.




Figure 4-15 Playback file (2)



Step 1 Click , and the snapshots on a selected day will be displayed in a list.

Step 2 To play back a snapshot, double-click the corresponding file.

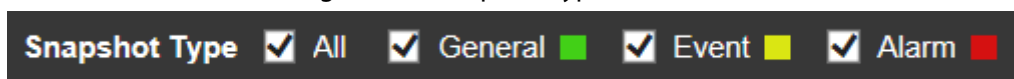
Table 4-10 Playback file parameter description

Parameter	Description
	Search all the snapshots from the start time to the end time on the selected date.
	Click the button to download the snapshot to local storage.
	Click the button to go back to the calendar interface.

4.2.3 Snapshot Types

After you select a snapshot type, only the files of the selected type are displayed in the file list.

Figure 4-16 Snapshot types



5 Setting

5.1 Camera

5.1.1 Conditions Settings

This section describes how to set camera attributes and manage profiles.

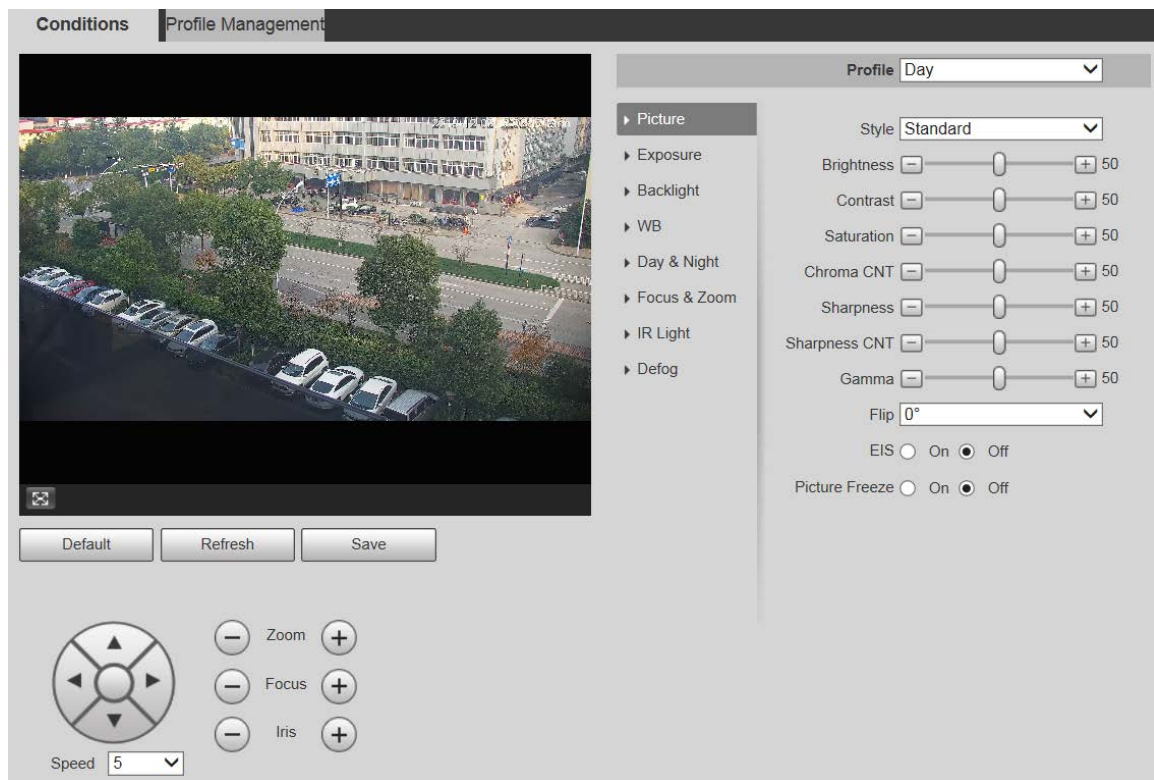
5.1.1.1 Conditions

5.1.1.1.1 Picture

You can set camera attributes and picture parameters to achieve the best display effect.

Step 1 Select **Setting > Camera > Conditions > Conditions > Picture**.





Figure 5-1 Picture interface



Step 2 Configure parameters as needed.

Table 5-1 Picture setting parameter description

Parameter	Description
Profile	There are three options: General , Day , and Night . You can view the configurations and the effect of the selected mode. Day is selected by default.
Style	Set the image display style. There are three options: Soft , Standard , and Vivid . Standard is selected by default.

Parameter	Description
Brightness	Set the overall image brightness. The larger the value is, the brighter the image will be. The value ranges from 0 to 100.
Contrast	Set the image contrast. The larger the value is, the greater the contrast will be. The value ranges from 0 to 100.
Saturation	Set the intensity of colors. The larger the value is, the brighter the colors will be. The value ranges from 0 to 100.
Chroma CNT	<p>The larger the value, the higher suppression on image colors. The value ranges from 0 to 100.</p>  <p>This parameter takes effect only when the Device is in the environment with low luminance.</p>
Sharpness	<p>Set the sharpness of picture edges. The larger the value is, the more obvious the edge will be. The value ranges from 0 to 100.</p>  <p>If the value is too large, there might be image noise. Set the value according to the actual condition.</p>
Sharpness CNT	<p>The larger the value is, the stronger the sharpness CNT will be. The value ranges from 0 to 100.</p>  <p>This parameter takes effect only when the Device is in the environment with low luminance.</p>
Gamma	Change image brightness through non-linear tuning to expand the dynamic display range of images. The larger the value is, the brighter the image will be. The value ranges from 0 to 100.
Flip	<p>Monitoring videos can be flipped over. There are two options.</p> <ul style="list-style-type: none"> ● 0°: The monitoring video is normally displayed. It is 0° by default. ● 180°: The monitoring video is flipped over.
EIS	<p>Electronic image stabilization (EIS) is used to effectively solve the problem of image shaking during use, thus presenting clearer images. It is Off by default.</p>  <ul style="list-style-type: none"> ● This function is available on select models. ● This parameter takes effect only when the Device is in the environment with low luminance. ● Optical image stabilization and electronic image stabilization cannot be enabled at the same time.
Picture Freeze	After you select On , the image at the called preset is displayed directly if you call a preset or tour, and no images during the rotation of the Device are displayed.

Step 3 Click **Save**.

5.1.1.1.2 Exposure

You can control the amount of light per unit area reaching the electronic image sensor by adjusting parameters on the **Exposure** interface.

Step 1 Select **Setting > Camera > Conditions > Conditions > Exposure**.

Figure 5-2 Exposure—auto mode

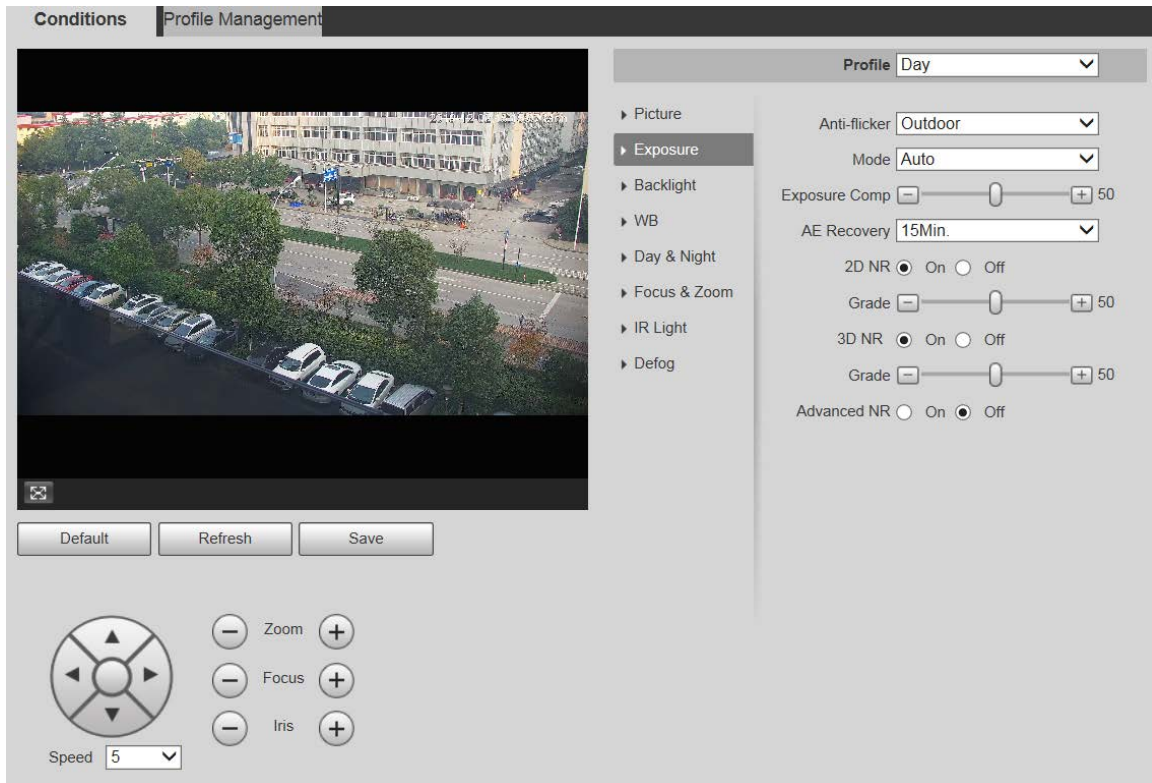


Figure 5-3 Exposure—aperture priority mode

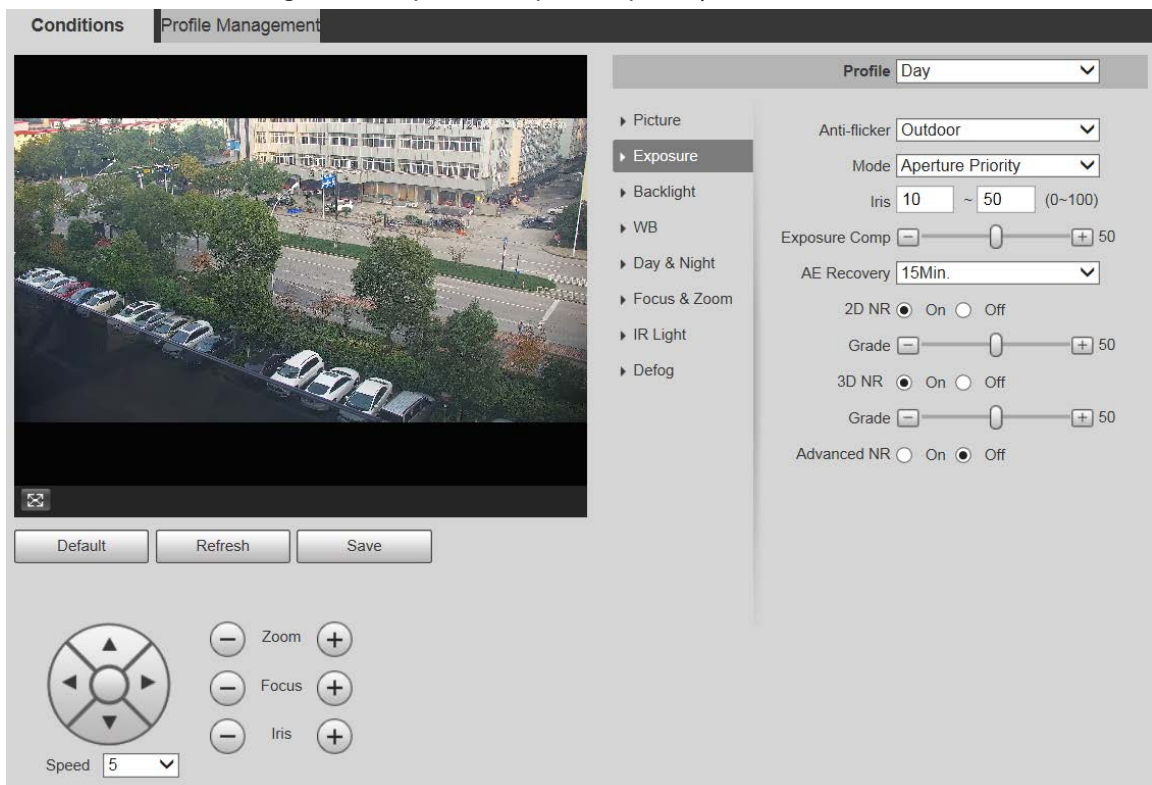


Figure 5-4 Exposure—shutter priority mode

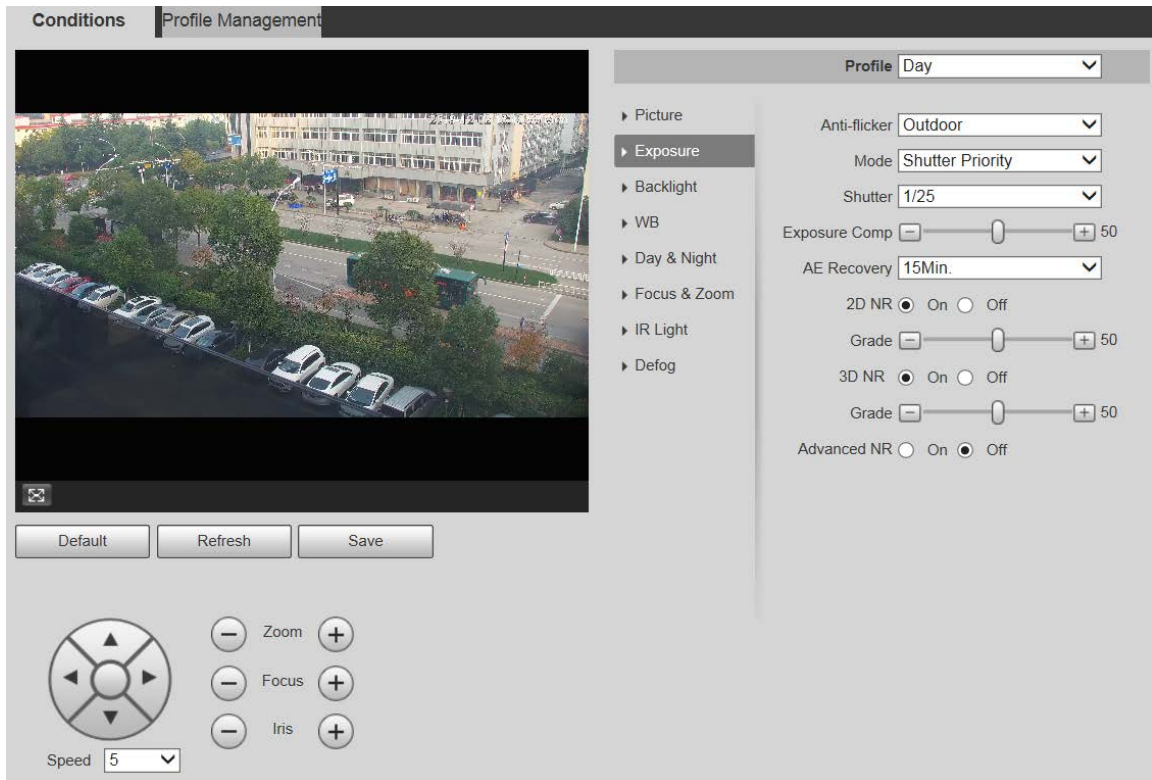


Figure 5-5 Exposure—gain priority mode

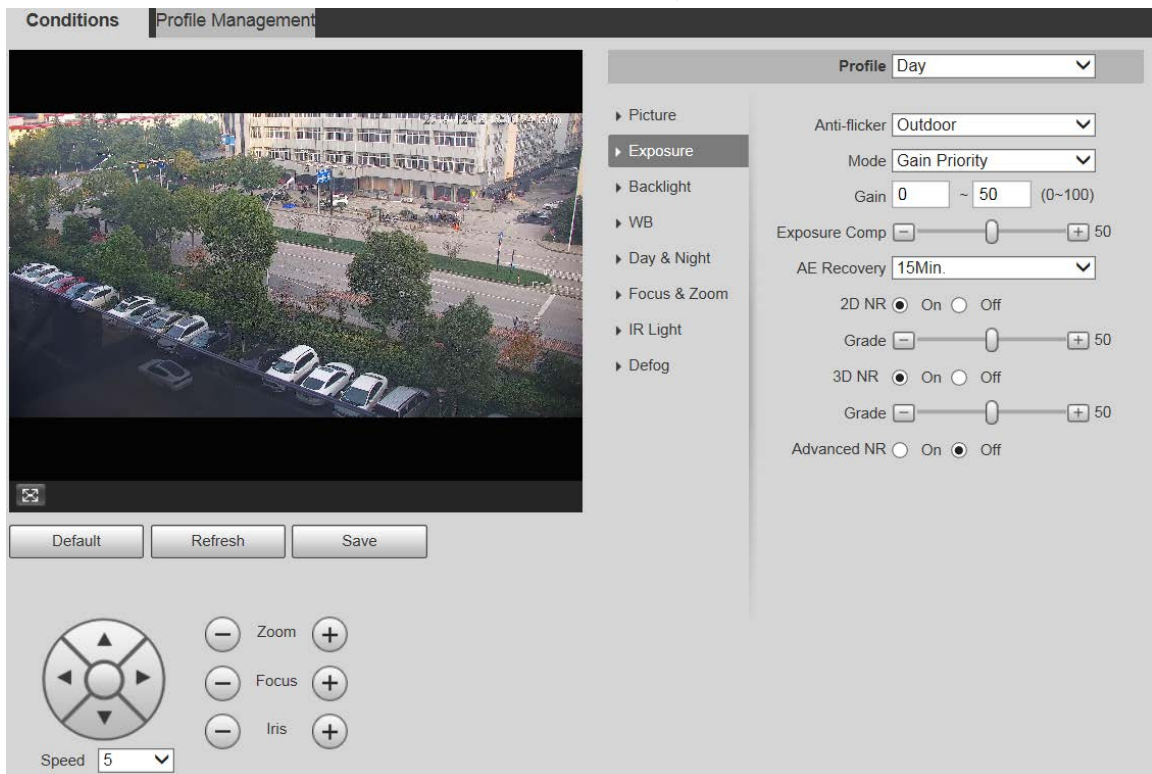
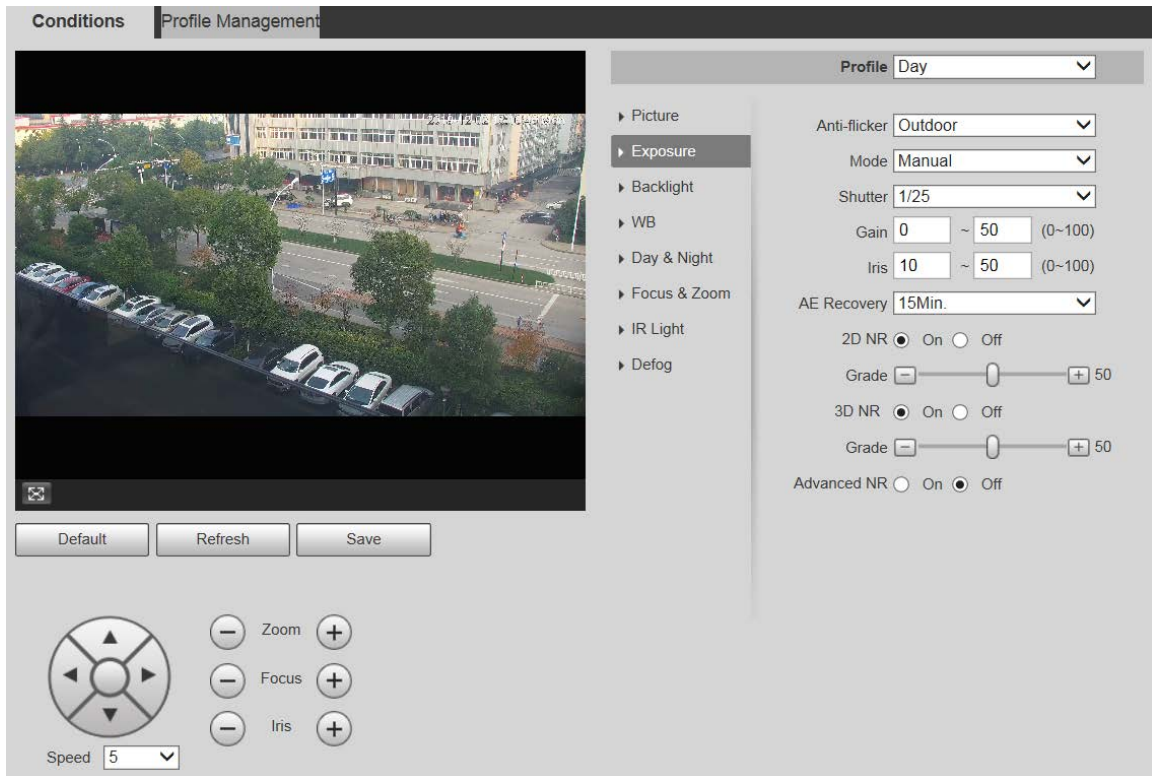



Figure 5-6 Exposure—manual mode



Step 2 Configure parameters as needed.

Table 5-2 Exposure setting parameter description

Parameter	Description
Anti-flicker	<p>You can select 50Hz, 60Hz, or Outdoor from the list.</p> <ul style="list-style-type: none"> • 50Hz: When the alternating current is 50Hz, the exposure is automatically adjusted to make sure that there are no stripes on images. • 60Hz: When the alternating current is 60Hz, the exposure is automatically adjusted to make sure that there are no stripes on images. • Outdoor: You can switch the modes to achieve the effect you want.

Parameter	Description
Mode	<p>Set the exposure modes. You can select Auto, Manual, Aperture Priority, Shutter Priority, or Gain Priority. The Auto mode is selected by default.</p> <ul style="list-style-type: none"> • Auto: Exposure is automatically adjusted according to scene brightness if the overall brightness of images is in the normal exposure range. • Manual: You can adjust the Gain, Shutter, and Iris value manually. • Aperture Priority: You can set the iris to a fixed value, and the Device adjusts shutter value then. If the image brightness is not enough and the shutter value has reached upper or lower limit, the system adjusts gain value automatically to ensure the image is at ideal brightness. • Shutter Priority: You can customize the shutter range. The Device automatically adjusts the aperture and gain according to the scene brightness. • Gain Priority: Gain value and exposure compensation value can be adjusted manually.
Gain	You can set the exposure gain. The value ranges from 0 to 100.
Shutter	You can adjust the exposure time of the Device. The larger the shutter value, the brighter the image.
Iris	You can set the Device luminous flux. The larger the iris value, the brighter the image.
Exposure Comp	You can set the exposure compensation value. The value ranges from 0 to 100.
AE Recovery	Automatic exposure is an automated digital camera system that adjusts the aperture and shutter speed, based on the external lighting conditions for images and videos. If you have selected an AE Recovery time, the exposure mode will be restored to the previous mode after you adjust the iris value. There are five options: Off , 5Min , 15Min , 1Hour , and 2Hour .
2D NR	2D noise reduction is the process of removing noise from a signal. The higher the grade is, the less the noise will be, and images appear to be blurrier.
3D NR	3D noise reduction is the process of removing noise from a signal. The higher the grade is, the less the noise will be, and images appear to be blurrier.
Grade	Noise reduction grade. The value ranges from 0 to 100. The larger the value is, the less the noise will be.
Advanced NR	<p>Realize noise suppression effect through 3D and 2D video filtering method.</p>  <p>The function is available on select models.</p>

Step 3 Click **Save**.

5.1.1.1.3 Backlight

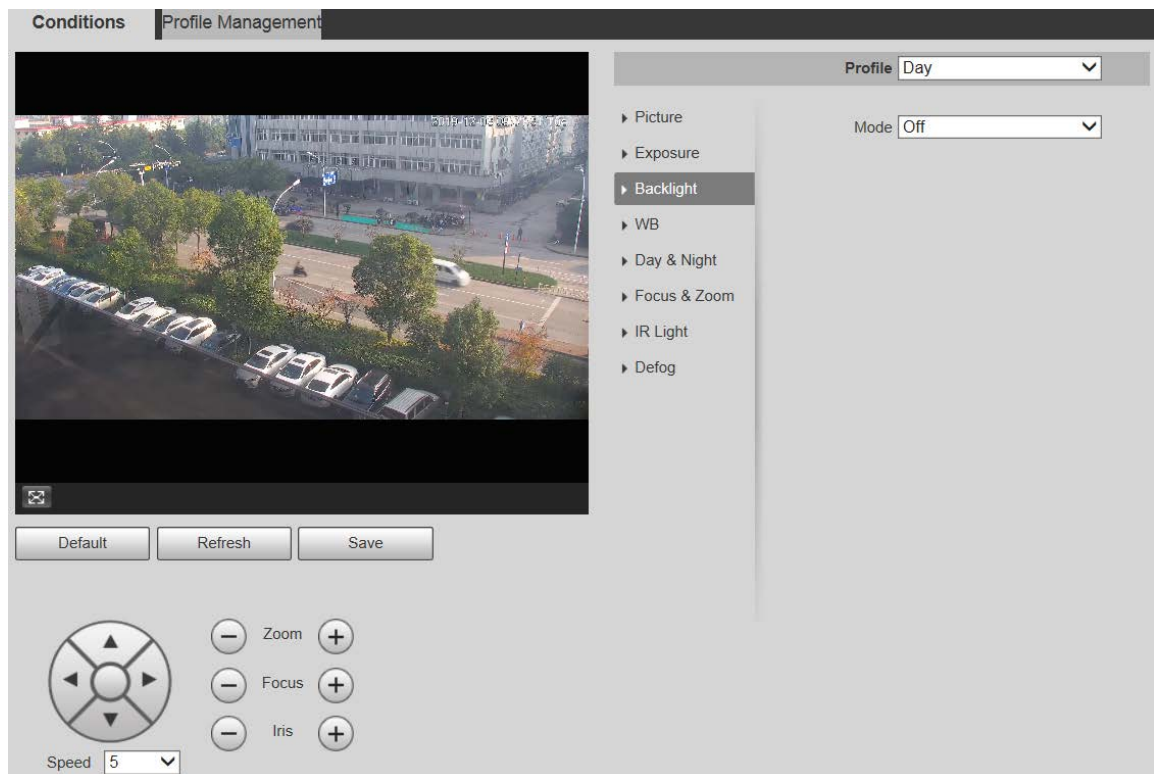


The backlight function cannot be configured if defog function is enabled. There will be a prompt on the interface.

You can use this function to adjust the backlight compensation mode of the monitoring screen.

Step 1 Select **Setting > Camera > Conditions > Conditions > Backlight**.

Figure 5-7 Backlight settings



Step 2 Select a backlight mode from the list.

There are 4 options: **Off**, **BLC**, **HLC**, and **WDR**.

- **Off**: Backlight is disabled.
- **BLC**: Backlight compensation corrects regions with extremely high or low levels of light to maintain a normal and usable level of light for the object in focus.
- **HLC**: Highlight compensation dims strong light, so that the Device can capture details of faces and license plates in extreme light conditions. It is applicable to the entrance and exit of toll stations or parking lots.
- **WDR**: When in WDR (Wide Dynamic Range) mode, the Device constrains over bright areas and compensates dark areas to improve the image clarity.

Step 3 Click **Save**.



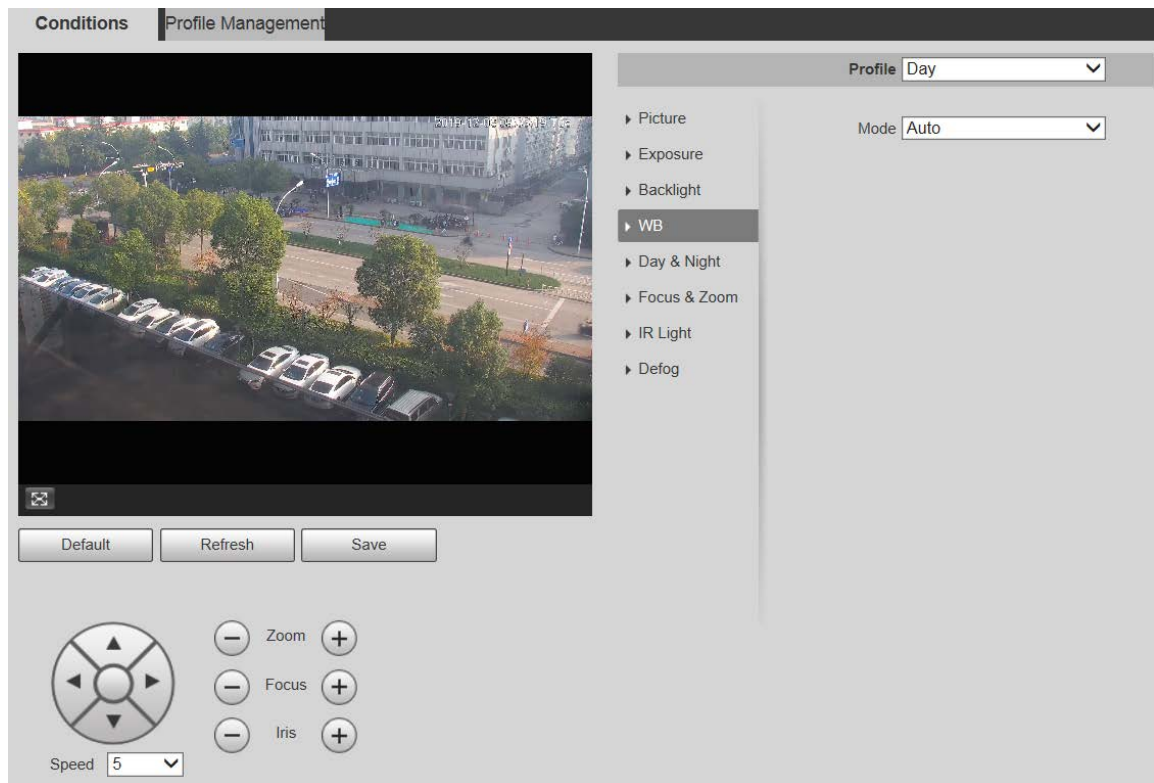
If you select **Off**, other backlight mode configurations will not be effective.

5.1.1.1.4 WB

In this mode, you can make a white object displaying itself clearly on the video image in all environments.

Step 1 Select **Setting > Camera > Conditions > Conditions > WB.**

Figure 5-8 WB settings



Step 2 Select WB mode from the list.

You can select from **Auto, Indoor, Outdoor, ATW, Manual, Sodium Lamp, Natural,** and **Street Lamp. Auto** is selected by default.

Step 3 Click **Save.**

5.1.1.1.5 Day & Night

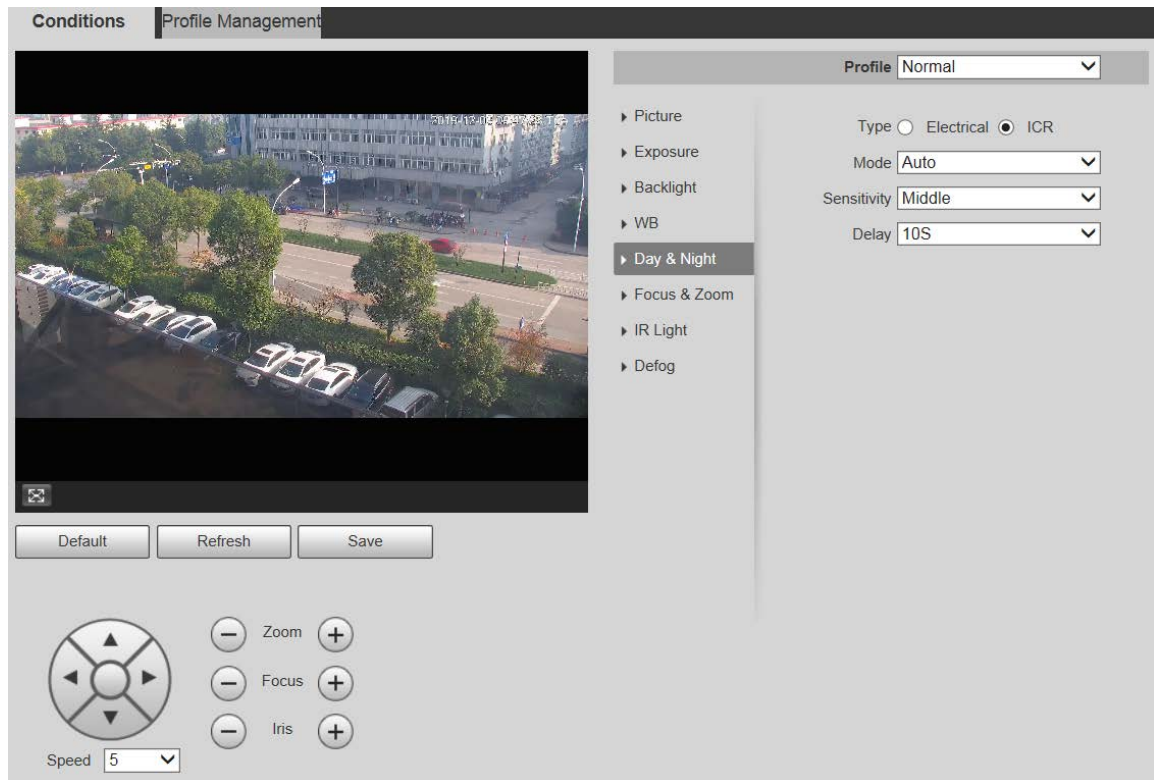
This function allows you to switch between the color mode and the black & white mode, ensuring clear monitoring screen in a dim environment.



Defog function cannot be configured if **Day & Night** function is enabled. There will be a prompt on the interface.



Step 1 Select **Setting > Camera > Conditions > Conditions > Day & Night.**

Figure 5-9 Day & night settings



Step 2 Configure parameters as needed.

Table 5-3 Day & night parameter description

Parameter	Description
Type	There are two options: Electrical and ICR . ICR is selected by default. <ul style="list-style-type: none"> • Electrical Image processing method is used for day & night switch. • ICR: IR filter is used for day & night switch.
Mode	Select a mode from the list (Your selection is independent from the profile). Auto is selected by default. <ul style="list-style-type: none"> • Color: The Device only outputs color images. • Auto: The Device outputs color images or black-and-white images according to ambient conditions. • B/W: The Device only outputs black-and-white images.
Sensitivity	Adjust the sensitivity to switch between different modes. There are three options: Low , Middle , and High .  You can set sensitivity only when Day & Night mode is set to Auto .
Delay	Adjust the delay time to switch between different modes. The value ranges from 2 s to 10 s.  You can set Delay only when Day & Night mode is set to Auto .

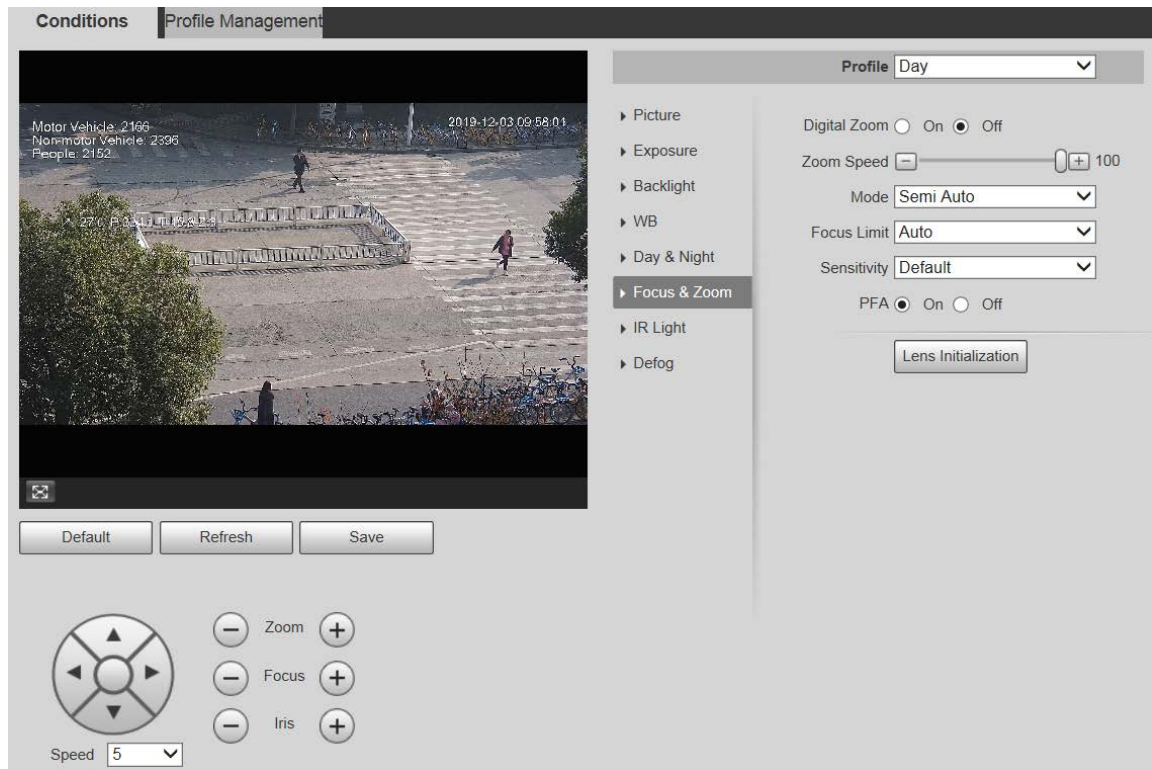
Step 3 Click **Save**.

5.1.1.1.6 Focus & Zoom

Digital zoom refers to capturing a part of the image to magnify it. The higher the magnification is, the blurrier the images will become.

Step 1 Select **Setting > Camera > Conditions > Conditions > Focus & Zoom**.

Figure 5-10 Focus & zoom settings



Step 2 Configure each parameter as needed.

Table 5-4 Focus & zoom parameter description

Parameter	Description
Digital Zoom	Select On or Off to enable or disable digital zoom. Off is selected by default.
Zoom Speed	The larger the value is, the faster the Device zooms.
Mode	Select the focus triggering mode. There are three options: Semi Auto , Auto , and Manual . Semi Auto is selected by default. <ul style="list-style-type: none"> • Semi Auto: The Device focuses automatically when zoom or ICR switch is detected. • Auto: The Device focuses automatically when scene changes, zoom, or ICR switch are detected. • Manual: The Device cannot focus automatically. You need to adjust the focus manually.
Focus Limit	You can select the shortest focus distance, which means the Device will focus on objects farther than the shortest focus distance. If you select Auto , the Device will select an appropriate shortest distance according to the zoom value.

Parameter	Description
Sensitivity	Sensitivity is the capacity of resisting interference of the Device when focusing. The smaller the value is, the more capable the Device can resist interference when focusing.
PFA	If you enable this function, the image is relatively clear during zoom. If you disable this function, the speed is relatively high during zoom.
Lens Initialization	Click this button, and the lens will be initialized automatically. The lens will be extended to calibrate the zoom and focus.

Step 3 Click **Save**.

5.1.1.1.7 IR Light

Common illuminators are classified into infrared IR lights, white lights, and laser lights. Different device models support different types of illuminators, and have different configuration interfaces. The actual interface shall prevail. This section describes how to configure these light types.

IR Light/White Light

These are the conditions for using IR light and white light.

- When the day & night mode is set to **B/W**, the monitoring screen is black and white. In this case, IR light is used.
- When the day & night mode is set to **Color**, the monitoring screen is colored. In this case, white light is used.
- When the day & night mode is set to **Auto**, the monitoring screen color changes with the ambient light condition, and the illuminator varies with the monitoring screen. In **B/W** mode, the IR light is turned on; in **Color** mode, the white light is turned on.



Some models are equipped with photoresistor that can turn on different types of illuminators based on the ambient brightness.

Perform the following steps to set illuminators.

Step 1 Select **Setting > Camera > Conditions > Conditions > IR Light**.

Figure 5-11 IR light settings—ZoomPrio

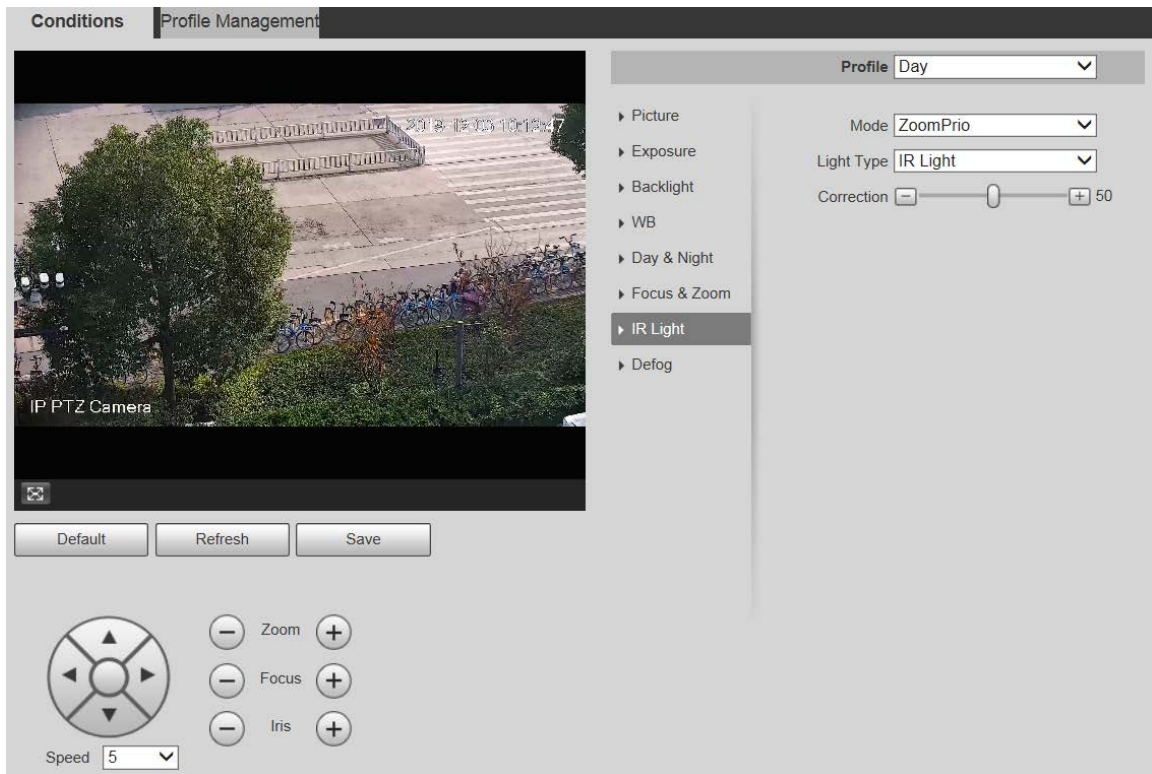


Figure 5-12 IR light settings—SmartIR

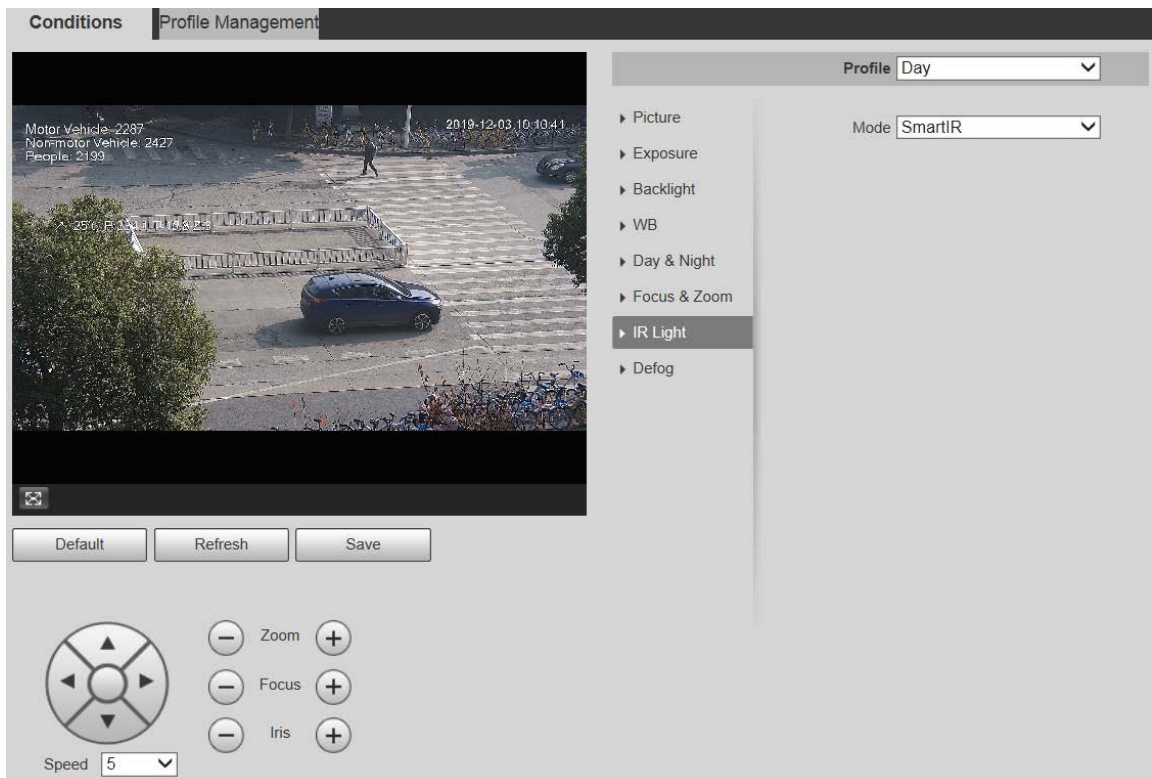


Figure 5-13 IR light settings—manual

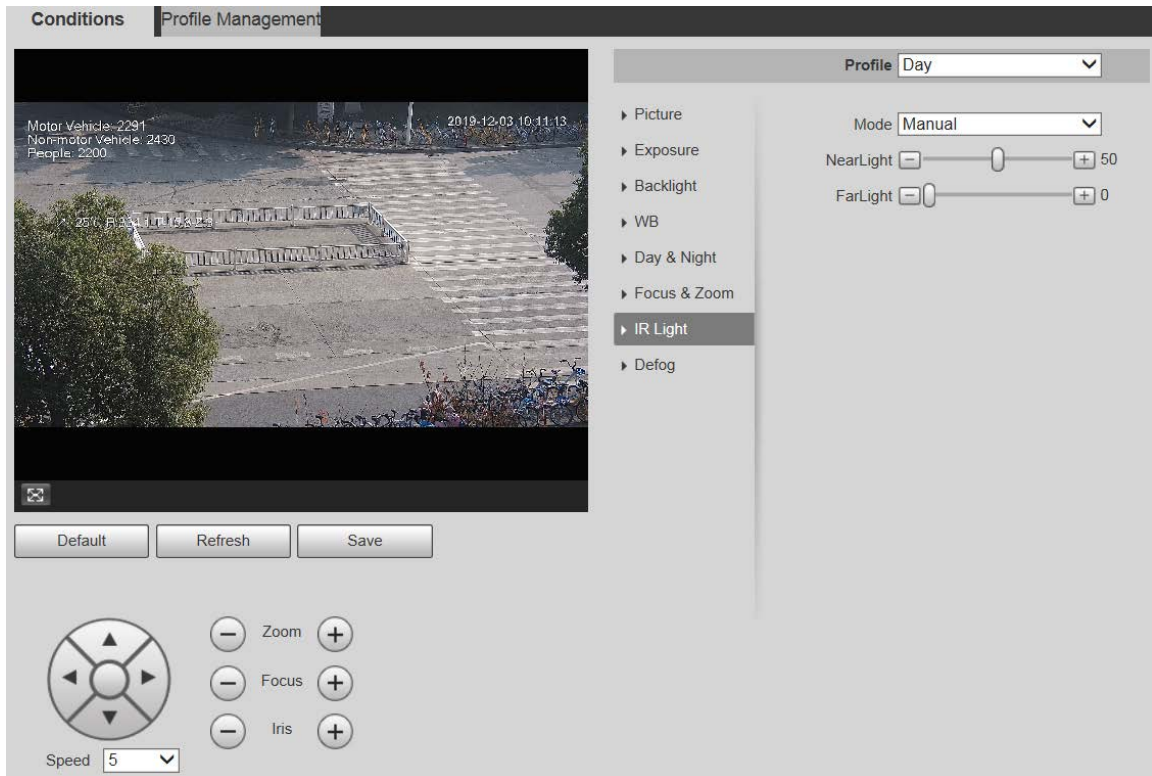
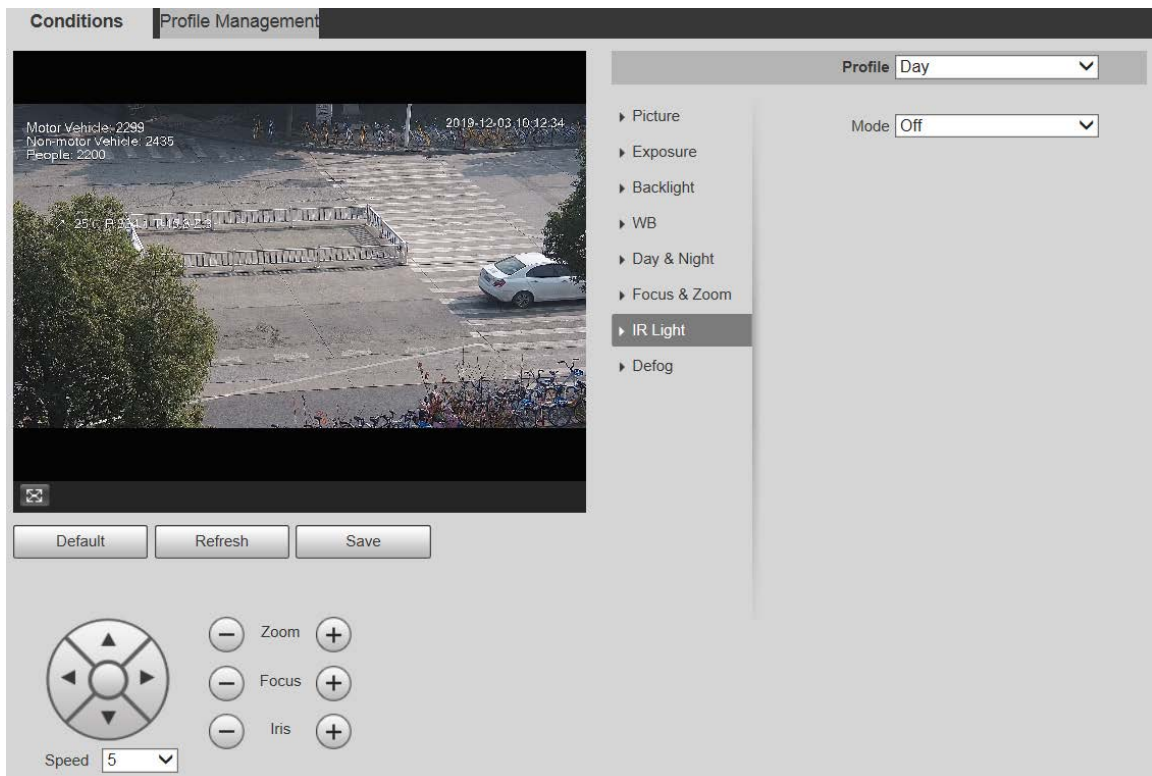



Figure 5-14 IR light setting—off



Step 2 Configure each parameter as needed.

Table 5-5 IR light parameter description

Parameter	Description
Mode	<p>There are 5 options: Manual, SmartIR, ZoomPrio, Timing, and Off.</p> <ul style="list-style-type: none"> ● ZoomPrio: The system adjusts the IR light brightness automatically according to the zoom times. ● SmartIR: The system controls the IR light intensity according to actual conditions. ● Manual: Set IR light brightness manually. ● Timing: Enable different light types in different time periods according to actual condition. ● Off: Turn off the IR light. <p></p> <ul style="list-style-type: none"> ● Some models do not support SmartIR, Manual, Timing, or Off. ● In ZoomPrio mode, IR light and white light are supported, and IR light is selected by default. ● In Timing mode, you can set four periods with different light types. ● Only infrared IR light supports the SmartIR mode. ● The IR light is turned off for cameras with low power consumption by default. Turn on the IR light if necessary.
Light Type	You can select IR Light or White Light .
Correction	Compensate for the brightness of the IR light. The value ranges from 0 to 100.
Near Light	Set the brightness of the near light. The value ranges from 0 to 100.
Far Light	Set the brightness of the far light. The value ranges from 0 to 100.

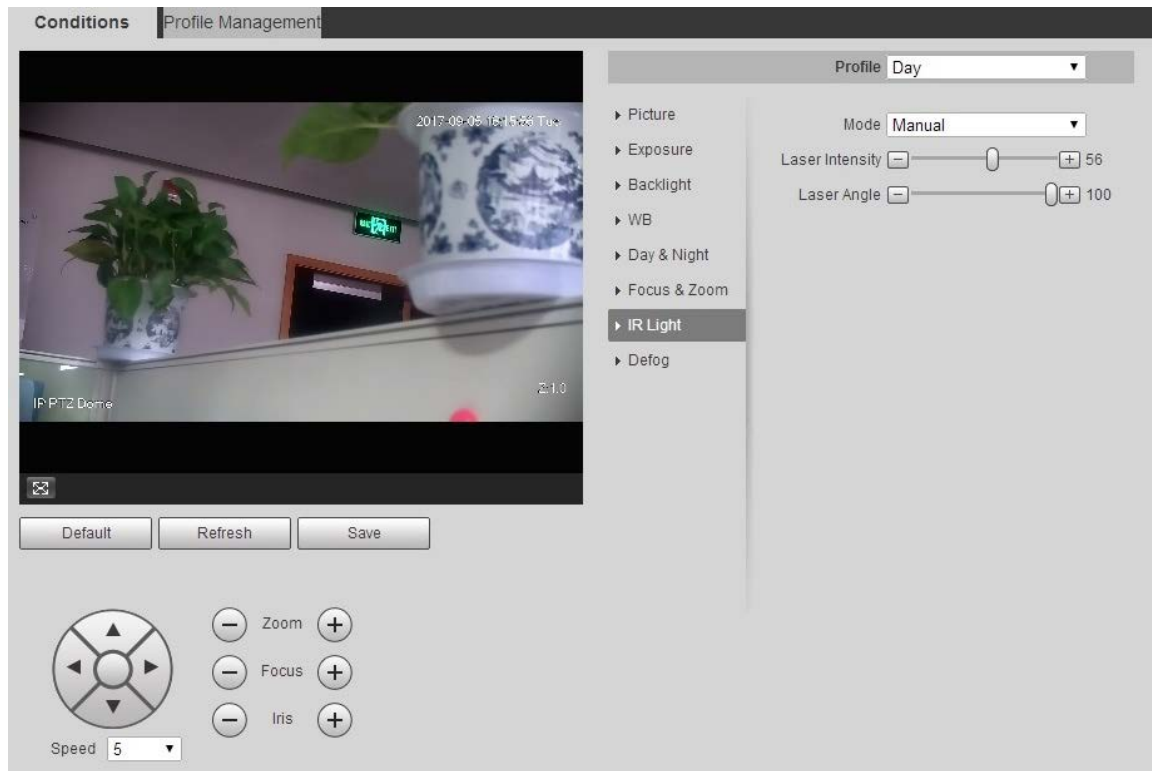
Step 3 Click **Save**.

Laser Light

Laser light makes compensation for the ambient environment when it is used for long-distance monitoring.

Step 1 Select **Setting > Camera > Conditions > Conditions > IR Light**.

Figure 5-15 Laser light settings



Step 2 Configure parameter as needed.

Table 5-6 Laser light setting parameter description

Parameter	Description
Mode	Select the laser light mode from ZoomPrio and Manual . It is ZoomPrio by default. <ul style="list-style-type: none"> • ZoomPrio: The Device can automatically adjust laser light brightness according to the zoom times. • Manual: Manually set laser light brightness and angle value.
Laser Intensity	Set the intensity of the laser light. The value ranges from 0 to 100.
Laser Angle	Set the angle value from 0 to 100.

Step 3 Click **Save**.

5.1.1.1.8 Defog



The defog function cannot be configured if backlight function is enabled. There will be a prompt on the interface.

Image quality drops if the Device is installed in foggy or hazy environment. You can enable defog to improve image quality.

Step 1 Select **Setting > Camera > Conditions > Conditions > Defog**.

Figure 5-16 Defog settings—manual

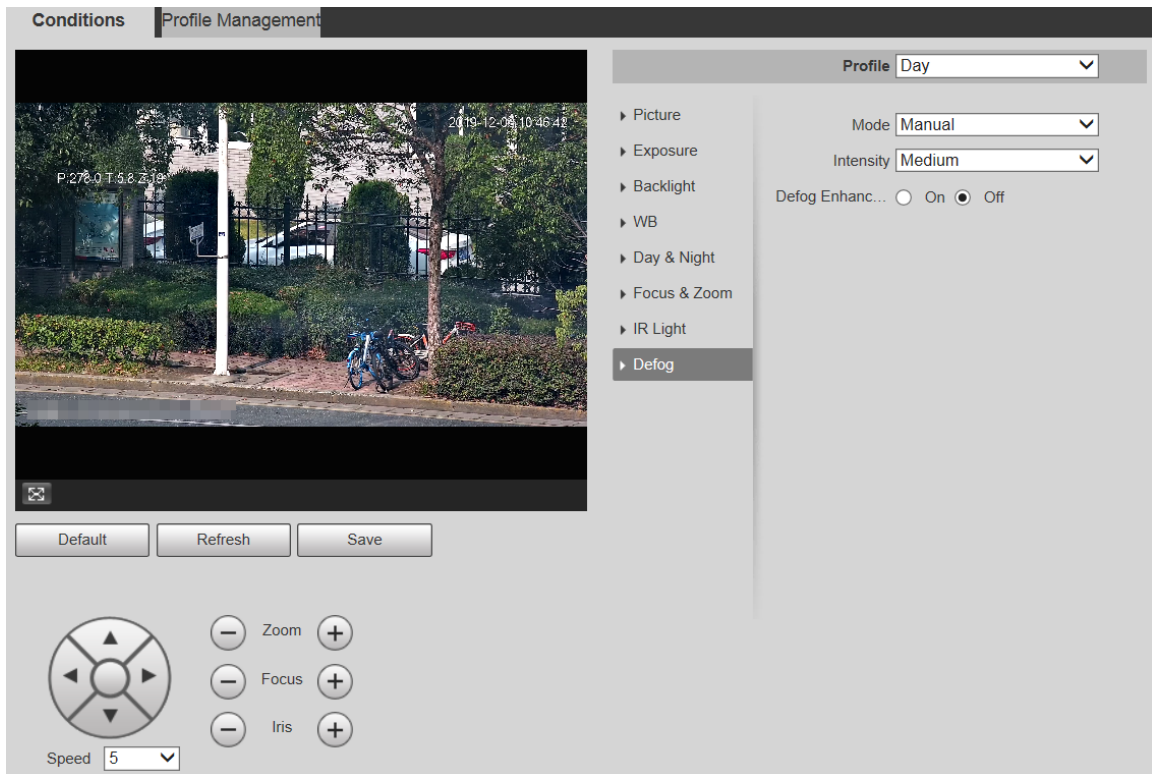
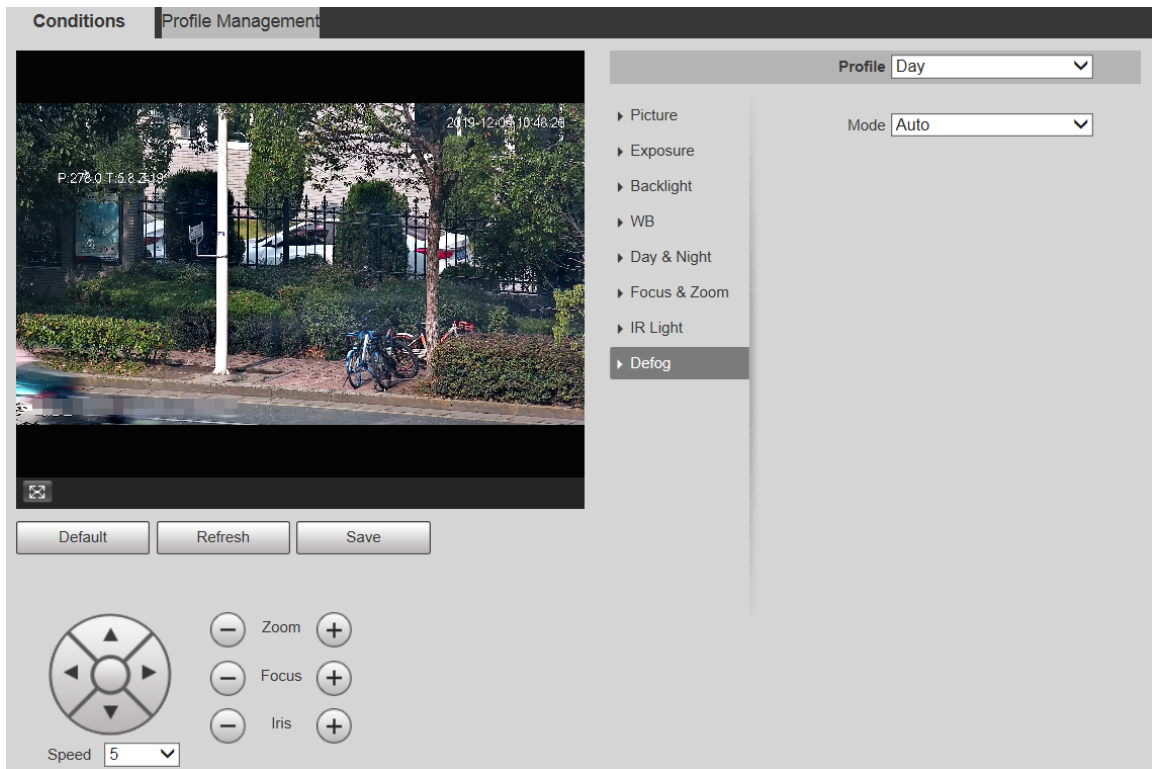




Figure 5-17 Defog settings—auto



Step 2 Configure parameters as needed.

Table 5-7 Defog parameter description

Parameter	Description
Mode	<p>Select the defog mode of the Device. You can select Auto, Manual, or Off. It is Off by default.</p> <p></p> <p>For the Device that supports optical defog, in Auto mode, optical defog and electronic defog switch automatically according to the algorithm. And in Off mode, electronic defog is enabled by default.</p>
Intensity	<p>Set the defog intensity of the Device. You can select from Low, Medium, or High.</p>
Defog Enhancement	<p>In Manual mode, if you enable this function, both optical defog and electronic defog are enabled. (You need to enable Auto mode for Day & Night to use the function.)</p> <p></p> <p>Only the Device that supports optical defog has this parameter.</p>

Step 3 Click **Save**.

5.1.1.2 Profile Management

Step 1 Select **Setting > Camera > Conditions > Profile Management**.

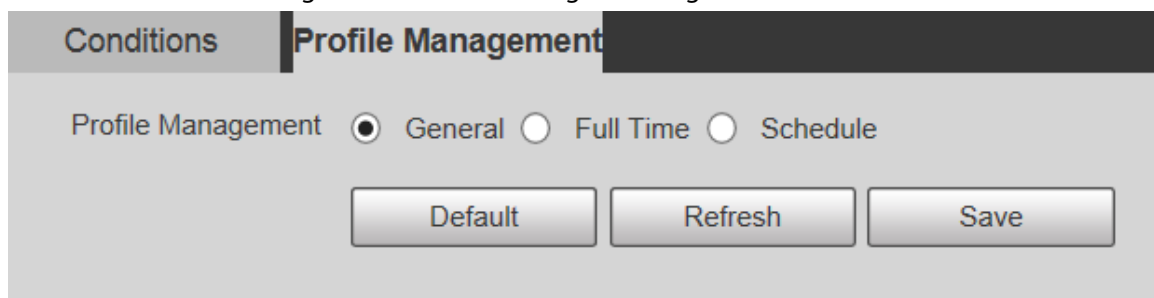
The **Profile Management** interface is displayed.

Step 2 Select the profile management mode.

There are three options: **General**, **Full Time** and **Schedule**.

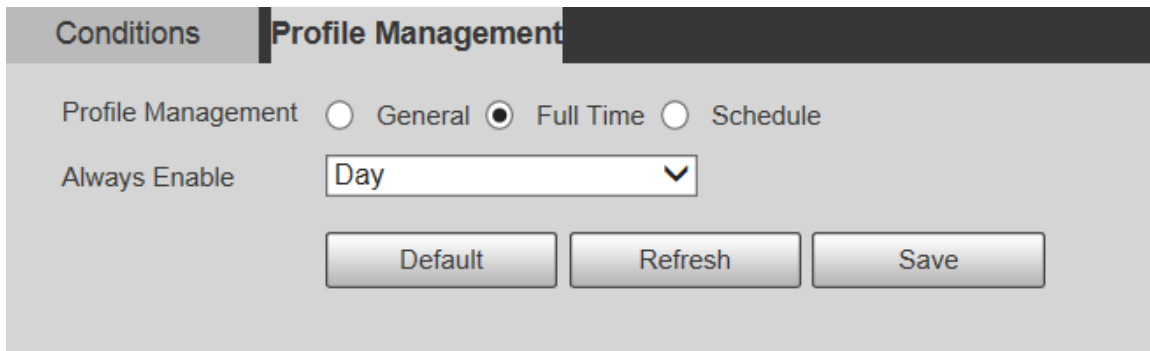
- If you select **General**, monitoring is based on the general configuration of the Device.

Figure 5-18 Profile management—general



- If you select **Full Time**, **Day** and **Night** are selectable, and the corresponding camera property profile is day or night.

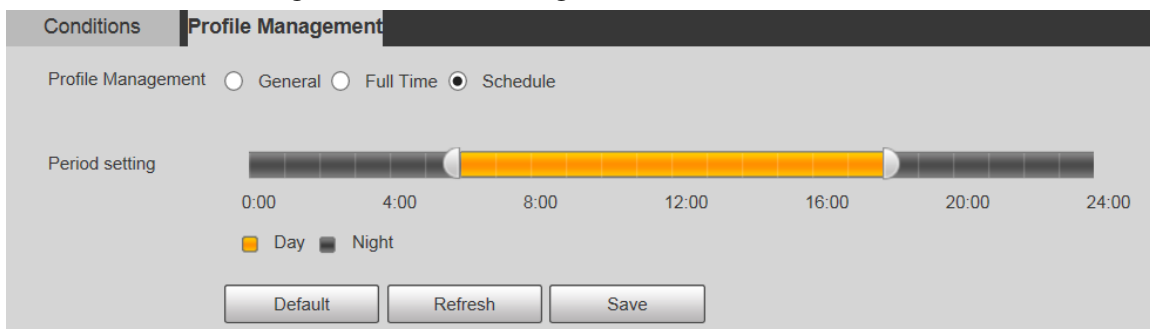
Figure 5-19 Profile management—full time



The screenshot shows the 'Profile Management' tab selected. Under 'Profile Management', the 'Full Time' radio button is selected. Below it, the 'Always Enable' dropdown menu is set to 'Day'. At the bottom, there are three buttons: 'Default', 'Refresh', and 'Save'.

- If you select **Schedule**, you can select one period for day configuration and another period for night configuration. For example, you can set the day-time configuration from 6:00 to 18:00, and set the night-time configuration from 18:00 to 6:00 on the next day.

Figure 5-20 Profile management—schedule



The screenshot shows the 'Profile Management' tab selected. Under 'Profile Management', the 'Schedule' radio button is selected. Below it, the 'Period setting' section features a timeline from 0:00 to 24:00. A yellow bar indicates the 'Day' period from approximately 6:00 to 18:00. A legend below the timeline shows a yellow square for 'Day' and a grey square for 'Night'. At the bottom, there are three buttons: 'Default', 'Refresh', and 'Save'.

Step 3 Click **Save**.

5.1.2 Video

You can set the video stream, snapshot stream, video overlay, ROI, and storage path of the Device.

5.1.2.1 Video Stream

This section describes how to set the video stream for the monitoring screen.

Step 1 Select **Setting > Camera > Video > Video**.


Figure 5-21 Video stream settings




- The stream configuration interfaces might vary depending on devices, and the actual interface shall prevail.
- The default bit rate of different devices might vary, and the actual product shall prevail.

Step 2 Configure parameters as needed.

Table 5-8 Video stream parameter description

Parameter	Description
Enable	You can select the check box to enable sub stream. The sub stream is enabled by default.
Encode Mode	You can select H.264 , H.264H , H.264B , H.265 , MJPEG , MPEG4 , or SVAC .
Smart Codec	Enable Smart Codec to improve video compressibility and save storage space.  After Smart Codec is enabled, the Device does not support the third stream, ROI, smart event, and other functions. The actual interface shall prevail.
Resolution	Multiple resolution types are available for you to choose, and each type corresponds to a unique recommended stream value.
Frame Rate (FPS)	PAL: 1–25 frames/s or 1–50 frames/s. The frame rate changes with the resolution.
Bit Rate Type	There are two options: CBR (constant bit rate) and VBR (variable bit rate). <ul style="list-style-type: none"> • Picture quality can be set only in VBR mode, and cannot be set in CBR mode. • In MJPEG encode mode, CBR is the only option for Bit Rate Type.
Reference Bit Rate	The recommended bit rate range is based on the resolution and frame rate.
Bit Rate	It is the upper limit of stream in VBR. In CBR, the value is fixed.
I Frame Interval	The number of P frames between two I frames. The range varies with the frame rate, and the maximum value is 150. It is recommended to set the interval twice the frame rate.
SVC	Layered encoding can be done for FPS. SVC is a scalable encoding method on time domain. It is 1 by default, which means no layered coding. You can set 2, 3 or 4 layered encoding.

Parameter	Description
Watermark Settings	You can verify the watermark to check if the video has been tampered.
Watermark Character	<p>You can verify the watermark to check if the video has been tampered. Select Watermark Settings check box to enable Watermark Character. The watermark character is DigitalCCTV by default, and you can modify it.</p>  <p>Watermark character consists of up to 128 characters from letters, standard symbols, spaces, and special characters.</p>

Step 3 Click **Save**.

5.1.2.2 Snapshot

This section describes how to set streams for snapshots.

Step 1 Select **Setting > Camera > Video > Snapshot**.

Figure 5-22 Snapshot stream settings

Step 2 Configure parameters as needed.

Table 5-9 Snapshot stream parameter description

Parameter	Description
Snapshot Type	<p>You can select General or Event.</p> <ul style="list-style-type: none"> General refers to capturing pictures within the time range set in the schedule. For details, see "5.6.1 Schedule". Event means capturing pictures when motion detection, video tampering, or local alarms are triggered. For how to enable snapshots for motion detection, video tampering, or local alarms, see "5.5 Event Management".
Image Size	It is the same as the resolution of the selected snapshot main stream, and cannot be modified on this interface.
Quality	You can set the snapshot quality from 1 to 6 levels. Level 1 is the lowest level, and level 6 is the highest level.
Interval	Set the snapshot frequency. You can select from 1 s through 7 s or Customized .

Step 3 Click **Save**.

5.1.2.3 Overlay

Configure overlay information, and it will be displayed on the **Live** interface.

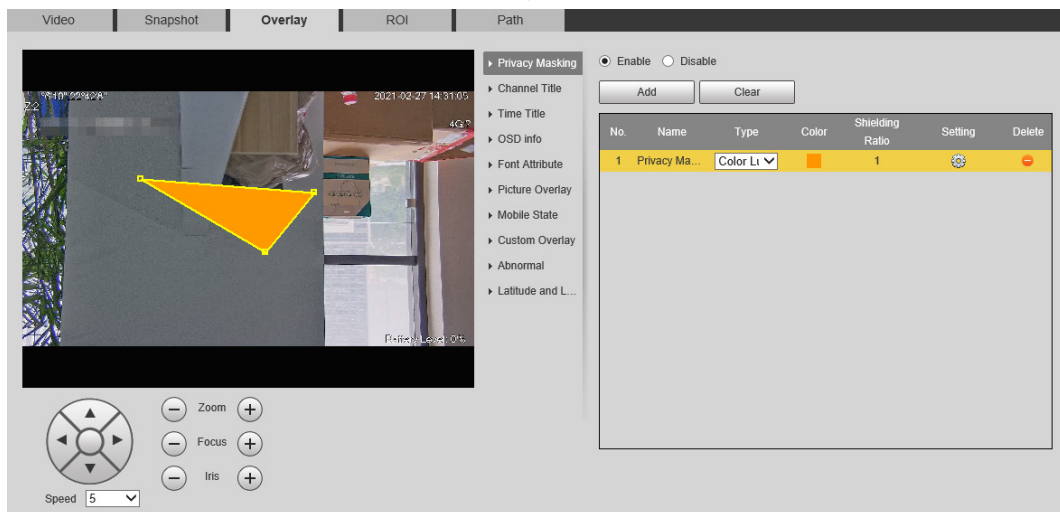
5.1.2.3.1 Privacy Masking

You can enable this function when you need to protect privacy of some areas on the video image.

Procedure

Step 1 Select **Setting > Camera > Video > Overlay > Privacy Masking**.

Figure 5-23 Privacy masking



Step 2 Select **Enable**.


Step 3 Click **Add**, select the masking type and color, set the shielding ratio, and then draw blocks on the image.



You can select the masking type from **Color Lump** and **Mosaic**.

- When selecting **Color Lump** only, you can draw triangles and convex quadrilaterals as blocks. You can drag 8 blocks at most.
- When selecting **Mosaic**, you can draw rectangles as blocks with mosaic. You can draw 4 blocks at most.
- When selecting both **Color Lump** and **Mosaic**, you can draw 8 blocks at most.

Related Operations

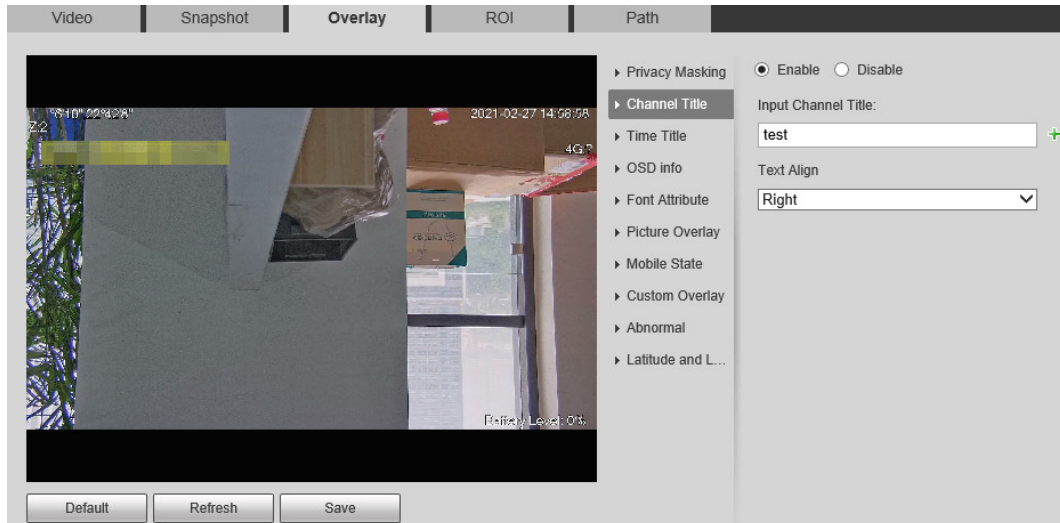
- View and edit the block
Select the privacy masking rule to be edited in the list, then the rule is highlighted, and the block frame is displayed in the image. You can edit the selected block as needed, including moving the position, and adjusting the size.
- Edit the block name
Double-click the block name to edit it.
- Delete the block
 - ◇ Click  to delete blocks one by one.
 - ◇ Click **Clear** to delete all blocks.

5.1.2.3.2 Channel Title

You can enable this function when you need to display channel title in the video image.

Step 1 Select **Setting > Camera > Video > Overlay > Channel Title**.

Figure 5-24 Channel title



Step 2 Select the **Enable** check box, enter the channel title, and then select the text alignment.



Click **+** to expand the channel title, and you can expand 1 line at most.

Step 3 Move the title box to the position that you want in the image.

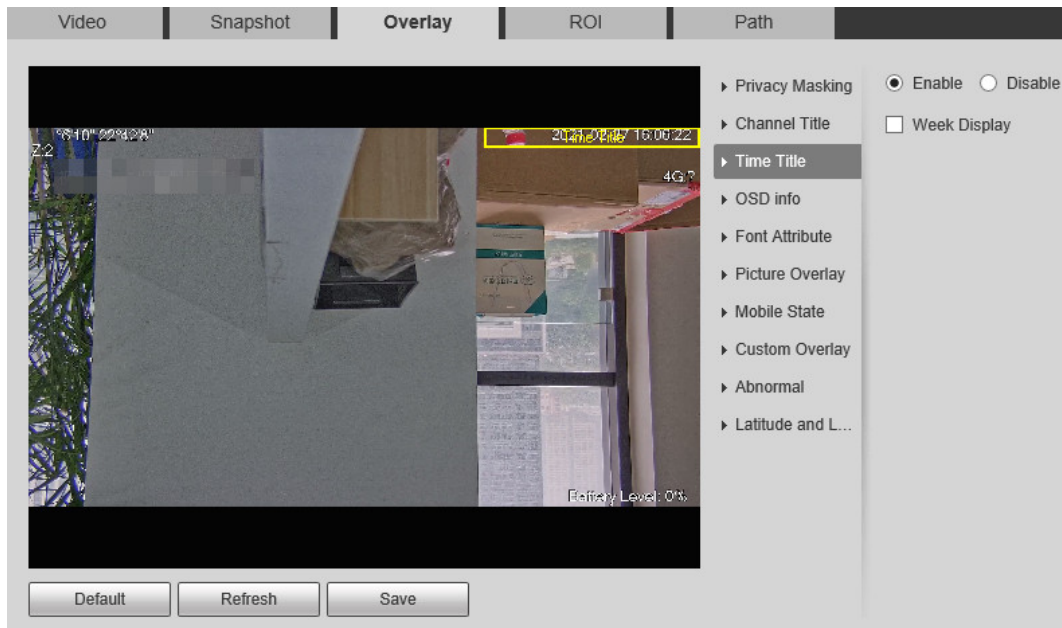
Step 4 Click **Save**.

5.1.2.3.3 Time Title

You can enable this function when you need to display time in the video image.

Step 1 Select **Setting > Camera > Video > Overlay > Time Title**.

Figure 5-25 Time title



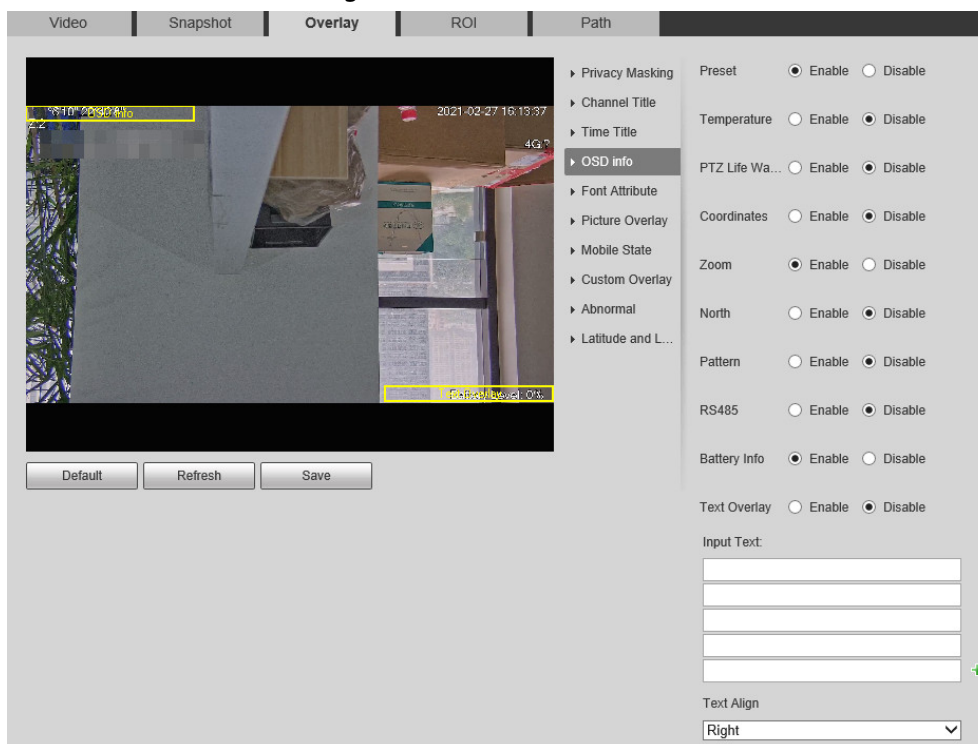
- Step 2 Select the **Enable** check box.
- Step 3 Select the **Week Display** check box.
- Step 4 Move the time box to the position that you want in the image.
- Step 5 Click **Save**.

5.1.2.3.4 OSD Info

You can enable this function if you want to display preset title, temperature, PTZ life warning, coordinates, zoom, north direction, pattern, RS-485, battery information, and other information on the video image.



- Step 1 Select **Setting > Camera > Video > Overlay > OSD Info**.

Figure 5-26 OSD info



Step 2 Configure OSD information.

Table 5-10 Description of OSD information

Parameter	Description
Preset	Select Enable , and the preset name is displayed on the image when the camera turns to the preset, and it will disappear 3 s later.  For some devices, you can set the duration of the preset title displaying on the screen. You can select from Disable, 5s, 15s, Display Permanently, and Custom.
Temperature	Select Enable , and the internal temperature of the current device is displayed.
PTZ Life Warning	When the PTZ lifespan is close to the threshold, a warning will be displayed on the video image. This OSD info is enabled by default.
Coordinates	Select Enable , and the PTZ coordinates information is displayed on the image.
Zoom	Select Enable , and the zoom information is displayed on the image. For example,  means 12x zoom rate.
North	Select Enable , and the north direction is displayed on the image.
Pattern	Select Enable , and the pattern information is displayed on the image.
RS485	Select Enable , and the RS-485 communication information is displayed on the image.
Battery Info	Select Enable , and the battery level is displayed on the image.
Text Overlay	Select Enable and enter text, and the text is displayed on the image.
Input Text	

Parameter	Description
Text Align	Set the alignment mode of the displayed information on the image.

Step 3 Move the OSD box to the position that you want on the image.

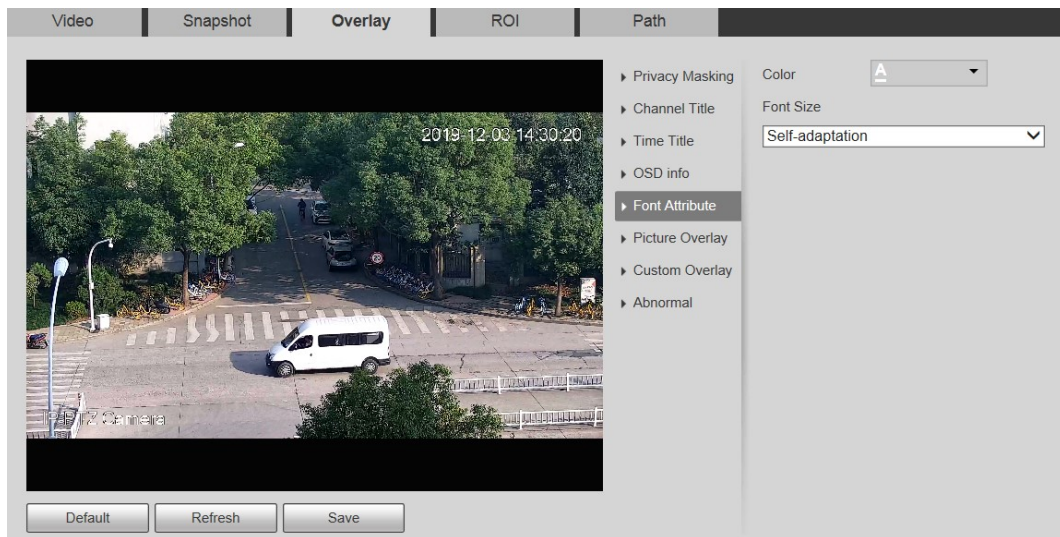
Step 4 Click **Save**.

5.1.2.3.5 Font Attribute

You can enable this function if you need to adjust the font size and color on the video image.

Step 1 Select **Setting > Camera > Video > Overlay > Font Attribute**.

Figure 5-27 Font attribute



Step 2 Select the font color and size.
Click **More Color** to customize the font color.

Step 3 Click **Save**.

5.1.2.3.6 Picture Overlay

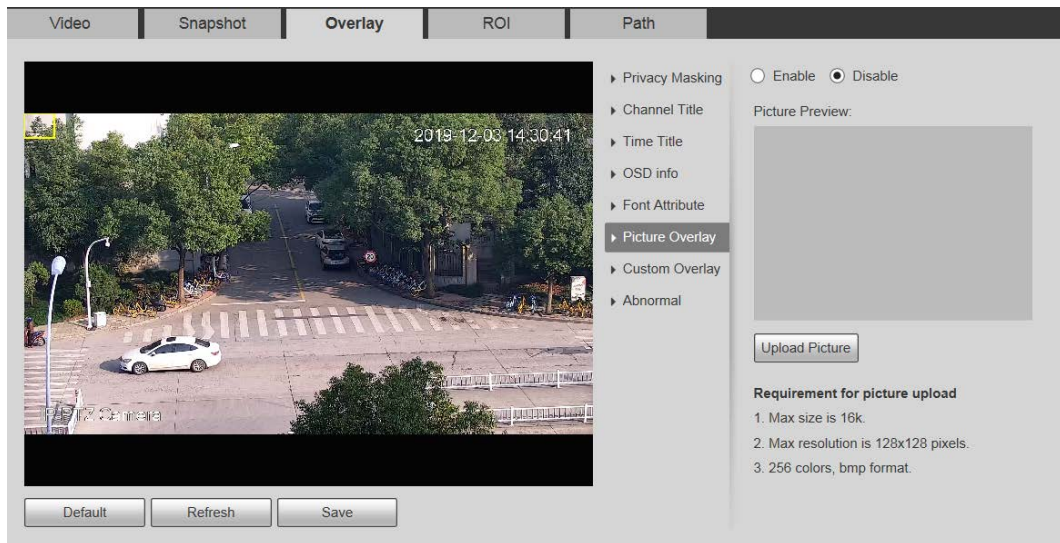
You can enable this function if you need to display picture on the video image.



Text overlay and picture overlay cannot be enabled at the same time.

Step 1 Select **Setting > Camera > Video > Overlay > Picture Overlay**.

Figure 5-28 Picture overlay



Step 2 Select the **Enable** check box, click **Upload Picture**, and then select the picture to be overlaid.

The picture is displayed on the video image.

Step 3 Move the overlaid picture to the position that you want on the image.

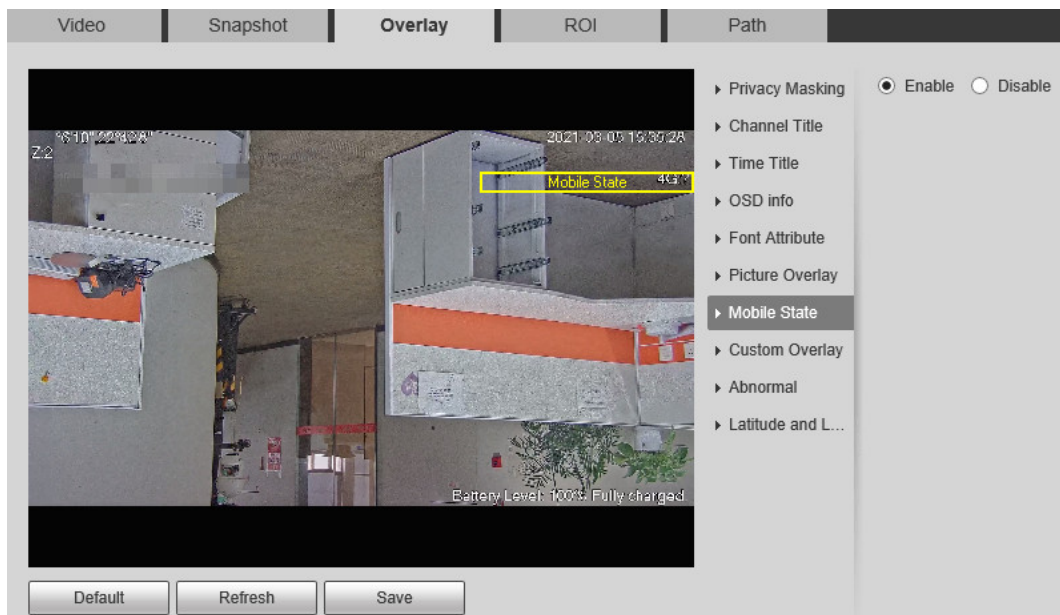
Step 4 Click **Save**.

5.1.2.3.7 Mobile State

You can enable this function if you want to display mobile state on the image.

Step 1 Select **Setting > Camera > Video > Overlay > Mobile State**.

Figure 5-29 Mobile state



Step 2 Select the **Enable** checkbox.

Step 3 Drag the mobile state box to the position that you want on the image.

Step 4 Click **Save**.

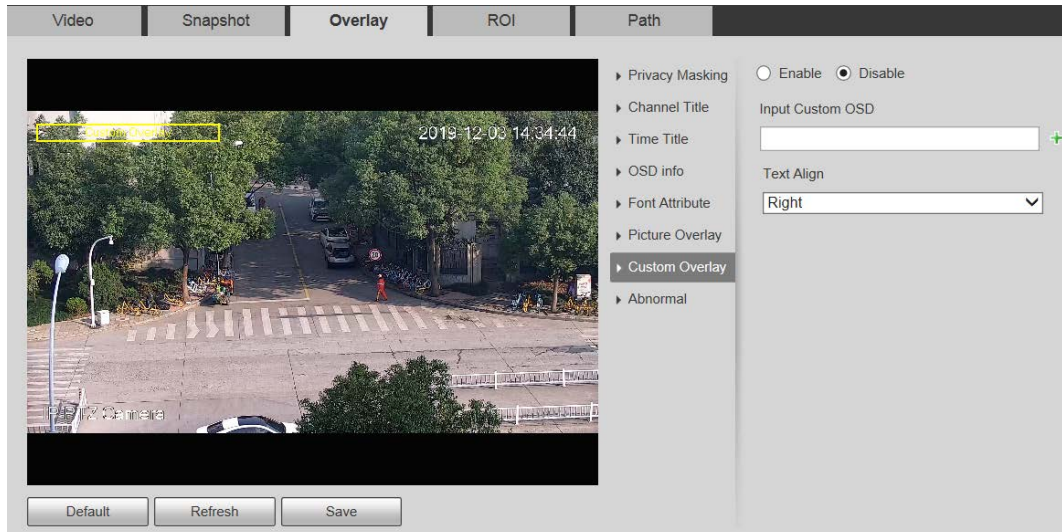
The mobile state information is displayed on the image.

5.1.2.3.8 Custom Overlay

You can enable this function if you need to display custom information on the video image.

Step 1 Select **Setting > Camera > Video > Overlay > Custom Overlay**.

Figure 5-30 Custom overlay



Step 2 Select the **Enable** check box, and then select the text alignment.



Click **+** to expand the custom overlay, and you can expand 1 line at most.

Step 3 Drag the custom overlay box to the position that you want on the image.

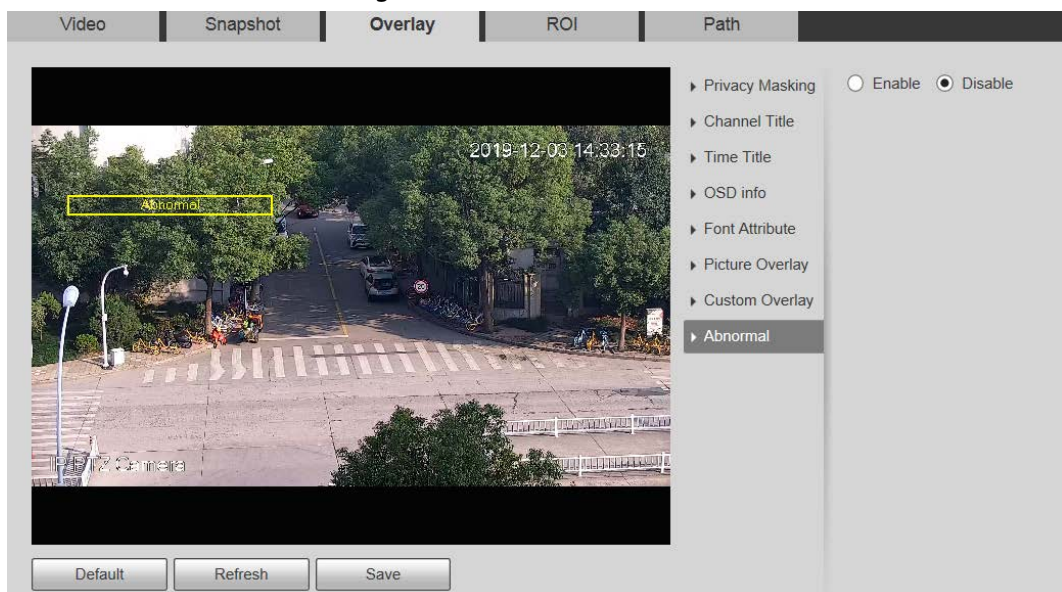
Step 4 Click **Save**.

5.1.2.3.9 Abnormal

You can enable this function if you want to display exception information on the image.

Step 1 Select **Setting > Camera > Video > Overlay > Abnormal**.

Figure 5-31 Abnormal



Step 2 Select the **Enable** checkbox.

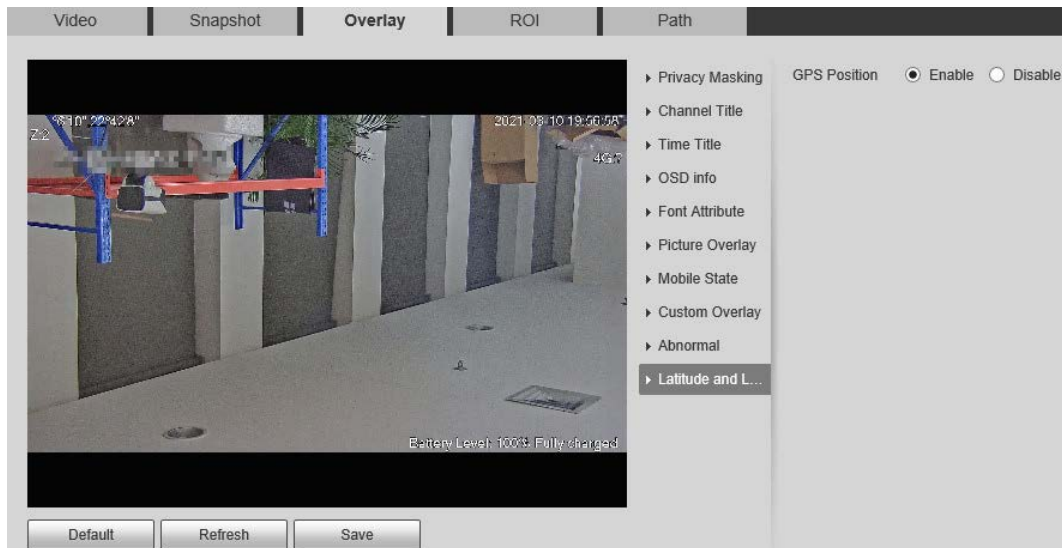
- Step 3** Drag the box to the position that you want on the image.
- Step 4** Click **Save**.
The exception information is displayed on the image.

5.1.2.3.10 Latitude and Longitude

You can enable this function if you need to display latitude and longitude on the video image.

- Step 1** Select **Setting > Camera > Video > Overlay > Latitude and Longitude**.

Figure 5-32 Latitude and longitude



- Step 2** Select the **Enable** check box.
- Step 3** Drag the box to the position that you want on the image.
- Step 4** Click **Save**.

5.1.2.4 ROI

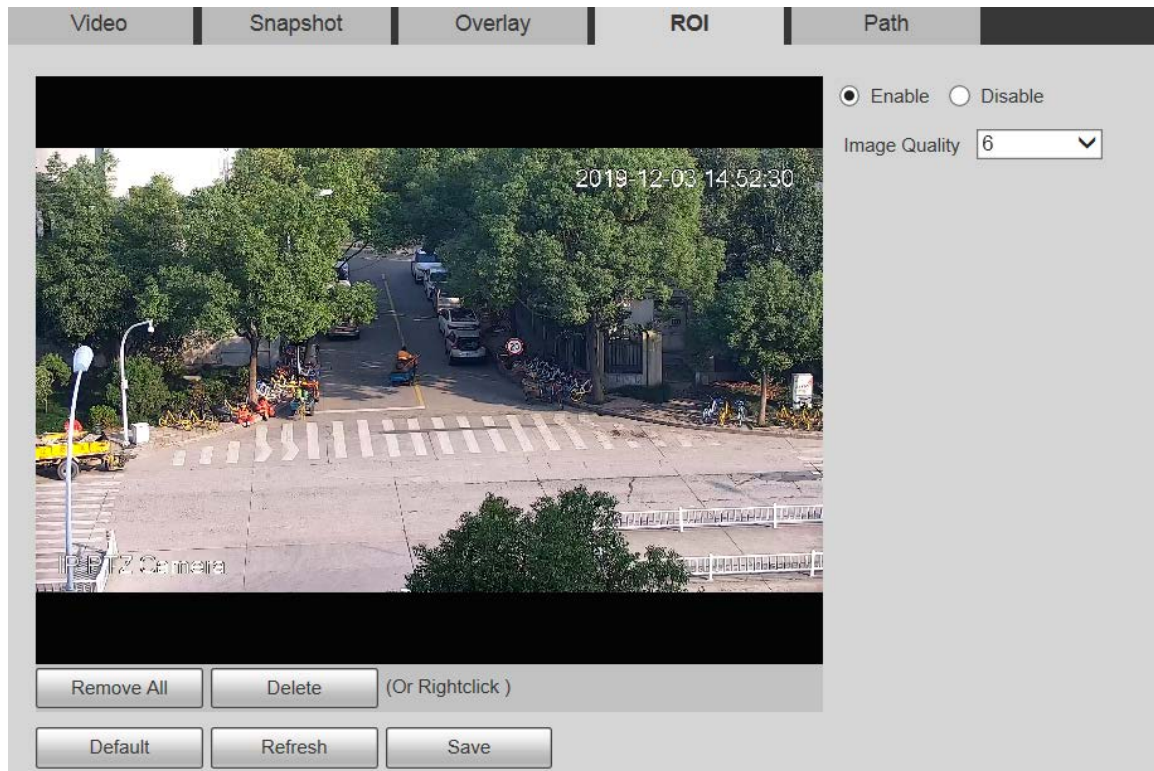
You can set a key monitoring region as a ROI (region of interest), and configure the image quality of this region.



ROI is available on select models.

- Step 1** Select **Setting > Camera > Video > ROI**.

Figure 5-33 ROI settings



Step 2 Select **Enable** to enable this function.

Step 3 Press and hold the left mouse button to draw boxes on the monitoring screen. You can draw up to 4 boxes.



- Click **Delete** or right click to delete the drawn boxes.
- Click **Remove All** to clear all boxes.

Step 4 Set the image quality of the ROI.

Step 5 Click **Save**.

5.1.2.5 Path

The storage path is associated with the snapshot and recording on the **Live** interface. You can set the path of **Live Snapshot** and **Live Record** respectively.

The storage path is associated with the snapshot, downloaded and clipped files on the **Playback** interface. You can set the path of **Playback Snapshot**, **Playback Download**, and **Video Clips** respectively.

Step 1 Select **Setting > Camera > Video > Path**.

Figure 5-34 Path settings

Video	Snapshot	Overlay	ROI	Path
Live Snapshot	C:\Users\...WebDownload\LiveSnapshot			Browse...
Live Record	C:\Users\...WebDownload\LiveRecord			Browse...
Playback Snapshot	C:\Users\...WebDownload\PlaybackSnapshot			Browse...
Playback Download	C:\Users\...WebDownload\PlaybackRecord			Browse...
Video Clips	C:\Users\...WebDownload\VideoClips			Browse...
Default		Save		

Step 2 Set each storage path.

- Default storage path for snapshots: C:\Users\admin\WebDownload\LiveSnapshot.
- Default storage path for recording: C:\Users\admin\WebDownload\LiveRecord.
- Default storage path for playback snapshot:
C:\Users\admin\WebDownload\PlaybackSnapshot.
- Default storage path for playback download:
C:\Users\admin\WebDownload\PlaybackRecord.
- Default storage path for video clips: C:\Users\admin\WebDownload\VideoClips.

Step 3 Click **Save**.

5.1.3 Audio

You can configure audio parameters and alarm audio.



The function is available on select models.

5.1.3.1 Configuring Audio Parameters

You can set the audio input type, volume and more. After you enable main stream or sub stream, the network stream contains both audio and video; otherwise it is only video stream.



Before enabling sub stream audio, go to **Setting > Camera > Video > Video** to enable video in sub stream.

Step 1 Select **Setting > Camera > Audio > Audio**.



Figure 5-35 Audio

Step 2 Enable audio in main stream or sub stream.

Step 3 Configure audio parameters.

Table 5-11 Description of audio parameters

Parameter	Description
Enable	Enable audio in main stream or sub stream. Audio can be enabled only when video has been enabled.
Encode Mode	The audio encoding mode selected here applies to both audio streams and voice talks. We recommend you to keep the default value.
Sampling Frequency	The number of audio signals sampled per second. The higher the sampling frequency, the more samples obtained per unit time, and the more accurate the restored audio signals.
AudiIn Type	Set the audio input type. <ul style="list-style-type: none"> • LineIn: The Camera collects audio signals through an external audio device. • Mic: The Camera collects audio signals through the built-in microphone. • Bluetooth: The Camera collects audio signals through a Bluetooth device. Bluetooth is available on select models.

Parameter	Description
Audio Output Type	Set the audio output type. <ul style="list-style-type: none"> • LineOut: The Camera outputs audio signals through an external audio device. • Speaker: The Camera outputs audio signals through the built-in speaker. • Bluetooth: The Camera outputs audio signals through a Bluetooth device.  Bluetooth is available on select models.
Noise Filter	After the function is enabled, noise in the environment will be filtered.
NR (Noise Reduction) Level	Adjust the noise reduction level.  This parameter takes effect when noise filter is enabled.
Microphone Volume	Adjust the microphone volume.
Speaker Volume	Adjust the speaker volume.

Step 4 Click **Save**.

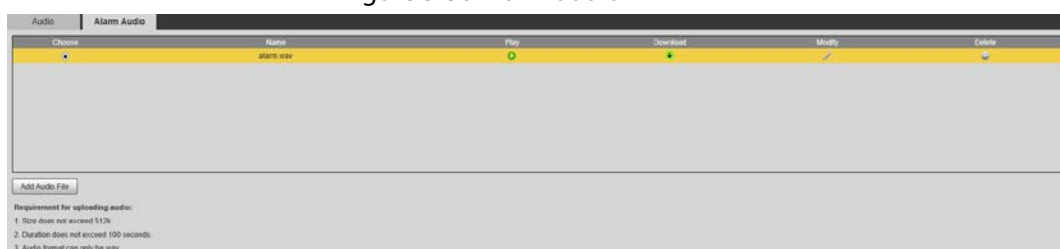
5.1.3.2 Configuring Alarm Audio

You can set the alarm audio to be played when an alarm is triggered. For some devices, you can record or upload alarm audios.

Procedure

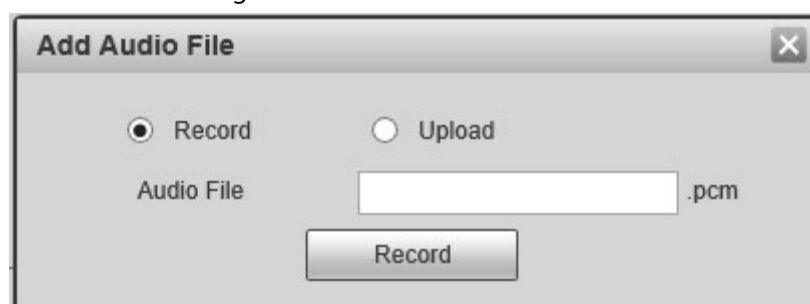
Step 1 Select **Setting > Camera > Audio > Alarm Audio**.

Figure 5-36 Alarm audio




Step 2 Click **Add Audio File**.



Figure 5-37 Add audio file



Step 3 Configure the audio file.



- Select **Record**, enter the audio file name, and then click **Record**.
Click **Stop** to complete recording.
- Select **Upload**, click , select the audio file to be uploaded, and then click **Upload**.



- The format of recorded audio is .pcm. Audio recording is only supported by some devices.
- Audio file in the format of .wav can be uploaded.
- You can edit and delete recorded or uploaded audio.
 - ◇ Click to  edit audio file.
 - ◇ Click  to delete audio file.

Step 4 Select the audio file that you need.

Related Operations

- Play audio: Click  to play the alarm audio.
- Download audio: Click  to download the alarm audio to local storage. The audio is saved to the default download path of the browser.

5.2 Network Settings

5.2.1 TCP/IP

You can configure the IP address and DNS server of the Device to connect it to other devices in the network.




Prerequisites

Before configuring network parameters, make sure that the Device is connected to the network properly.

- If there is no router in the network, assign an IP address in the same network segment.
- If there is a router in the network, set the corresponding gateway and subnet mask.

Procedure

Step 1 Select **Setting** > **Network** > **TCP/IP**.

Parameter	Description
MAC Address	Display the MAC address of the Device.
IP Version	You can select IPv4 or IPv6 . Both versions are supported and can be accessed.
IP Address	Enter correct digits to change the IP address.
Subnet Mask	<p>Set the subnet mask according to actual conditions. The subnet prefix is a number in the range of 1 to 255. The subnet prefix identifies a specific network link, and usually contains a hierarchical structure.</p>  <p>The Device checks the validity of all IPv6 addresses. The IP address and the default gateway must be in the same network segment. Make sure that a certain part of the subnet prefix in the IP address and default gateway are the same.</p>
Default Gateway	<p>Configure as needed. The default gateway must be in the same network segment as the IP address.</p>  <p>For IPv6 version, in the IP Address, Default Gateway, Preferred DNS, and Alternate DNS fields, enter 128 bits, and these fields cannot be blank.</p>
Preferred DNS	IP address of the DNS server.
Alternate DNS	Alternate IP address of the DNS server.
MTU	<p>You can set the MTU value to ensure good data transmission according to the network. The value is 1500 by default. Modifying MTU value causes Ethernet card restarting and network disconnection.</p>  <p>Here are some suggested value for your reference.</p> <ul style="list-style-type: none"> • 1500: It is the maximum and default value of Ethernet packet, typical setting of the network connection without PPPOE or VPN, and is the default setting of some routers, network adapters, and switches. • 1492: The optimal value for PPPOE. • 1468: The optimal value for DHCP. • 1450: The optimal value for VPN.
Enable ARP/Ping to set IP address service	<p>Select the check box, and then you can modify and set the device IP address through ARP/Ping command if the MAC address is known.</p> <ul style="list-style-type: none"> • The function is enabled by default. During reboot, you will have no more than 2 minutes to configure the Device IP address by a ping packet with certain length. • The server will be turned off in 2 minutes, or it will be turned off immediately after the IP address is successfully configured. If the function is not enabled, the IP address cannot be configured with ping packet.

Step 3 Click **Save**.

5.2.1.1 An Example of Configuring IP Address with ARP/Ping

- Step 1 To obtain a usable IP address, make sure that the Device and your PC are in the same LAN.
- Step 2 Get the MAC address from the Device label.
- Step 3 Open command editor on the PC and enter the following command.

Table 5-13 Command list

System	Command
Windows syntax	<pre>arp -s <IP Address> <MAC> ping -l 480 -t < IP Address > Example: arp -s 192.168.1.125 11-40-8c-18-10-11 ping -l 480 -t 192.168.0.125</pre>
UNIX/Linux/Mac syntax	<pre>arp -s <IP Address> <MAC> ping -s 480 < IP Address > Example: arp -s 192.168.1.125 11-40-8c-18-10-11 ping -s 480 192.168.0.125</pre>
Win7 syntax	<pre>netsh i i show in netsh -c "i i" add neighbors ldx <IP Address> <MAC> ping -l 480 -t < IP Address > Example: netsh i i show in netsh -c "i i" add neighbors 12 192.168.1.125 11-40-8c-18-10-11 ping -l 480 -t 192.168.1.125</pre>

- Step 4 Power off the Device and then restart it, or restart the Device over the network.
- Step 5 Check the PC command line. If there is information such as "Reply from 192.168.1.125...", it means the configuration succeeds. In this case, you can close the command editor.
- Step 6 Enter `http://<IP address>` in the browser address bar to log in.

5.2.2 Port

You can configure the maximum port numbers and values on this interface.

- Step 1 Select **Setting > Network > Port**.

Figure 5-39 Port interface

Port

Max Connection	<input type="text" value="10"/>	(1~20)
TCP Port	<input type="text" value="37777"/>	(1025~65534)
UDP Port	<input type="text" value="37778"/>	(1025~65534)
HTTP Port	<input type="text" value="80"/>	
RTSP Port	<input type="text" value="554"/>	
HTTPS Port	<input type="text" value="443"/>	
5000 Port	<input checked="" type="radio"/> Enable <input type="radio"/> Off	



Step 2 Configure each port value of the Device.



- Except **Max Connection**, modifications of other parameters will take effect after restart.
- 0–1024, 1900, 3800, 5000, 5050, 9999, 37776, 37780–37880, 39999, and 42323 are occupied for specific uses.
- It is not recommended to use the default values of other ports during port configuration.

Table 5-14 Port parameter description

Parameter	Description
Max Connection	The maximum number of users that can log in to the web interface of the Device simultaneously. The value ranges from 1 to 10, and it is 10 by default.
TCP Port	TCP service port. The value is 37777 by default. You can set this parameter as needed.
UDP Port	User Datagram Protocol port. The value is 37778 by default. You can set this parameter as needed.
HTTP Port	HTTP communication port. The value is 80 by default. You can set this parameter as needed.

Parameter	Description
RTSP Port	<p>Real Time Streaming Protocol port. Keep the default value 554 if it is displayed. If you play live view through Apple's QuickTime or VLC, the following format is available. This function is also supported by Blackberry mobile phone.</p> <p>When the URL format requiring RTSP, you need to specify channel number and bit stream type in the URL, and also username and password if needed.</p> <p>When playing live view with Blackberry mobile phone, you need to disable the audio, and then set the stream encoding mode to H.264B and resolution to CIF.</p> <p>URL format example: rtsp://username:password@ip:port/cam/realmonitor?channel=1&subtype=0</p> <ul style="list-style-type: none"> • Username: Your username. For example, admin. • Password: Your password. For example, admin. • IP: Your device IP. For example, 192.168.1.122. • Port: Leave it if the value is 554 by default. • Channel: Channel number starting from 1. For example, if it is channel 2, then enter channel=2. • Subtype: stream type. The main stream is 0 (subtype=0); the sub stream is 1 (subtype=1). <p>For example, if you require the sub stream of channel 2 from a certain device, then the URL shall be: rtsp://admin:admin@192.168.1.123:554/cam/realmonitor?channel=2&subtype=1</p> <p>If certification is not required, you do not need to specify the username and password. Use the following format: rtsp://ip:port/cam/realmonitor?channel=1&subtype=0</p>
RTMP	<p>A network protocol for real-time data communication. The value is 1935 by default. You can enter the value as needed.</p> <p></p> <p>Enable RTMP to push audio and video data to the third-party server. Make sure that the address is trusted; otherwise it might cause data leakage.</p>
HTTPS Port	<p>HTTPS communication port. The value is 443 by default. You can set this parameter as needed.</p>
5000 Port	<p>The port is disabled by default. If you need to connect the Camera to intelligent transportation box through 5000 port, enable this port.</p> <p></p> <p>There might be network risk if the port is enabled. Be cautious.</p>

Step 3 Click **Save**.

5.2.3 PPPoE

You can enable PPPoE (Point-to-Point Protocol over Ethernet) to establish network connection. In this case, the Device obtains a dynamic IP address. To use this function, you need to obtain the

PPPoE username and password from the Internet Service Provider (ISP).

Step 1 Select **Setting** > **Network** > **PPPoE**.

Figure 5-40 PPPoE interface (1)

The screenshot shows the PPPoE configuration page. At the top, the title 'PPPoE' is displayed. Below it, there is a checkbox labeled 'Enable' which is currently unchecked. Underneath, there are two input fields: 'Username' with the text 'none' and 'Password' which is empty. At the bottom of the form, there are three buttons: 'Default', 'Refresh', and 'Save'.

Step 2 Select **Enable**, and then enter PPPoE username and password.

Step 3 Click **Save**.

Save Succeeded! is displayed, and the obtained IP address of public network is displayed in real time. See Figure 5-41. You can access the Device through the IP address.

Figure 5-41 PPPoE interface (2)

The screenshot shows the PPPoE configuration page after being updated. The 'Enable' checkbox is now checked. The 'Username' field contains the text 'public' and the 'Password' field is filled with a series of black dots. The 'Default', 'Refresh', and 'Save' buttons remain at the bottom.

5.2.4 DDNS

Properly configure DDNS, and then the domain name on the DNS server matches your IP address and refresh the matching relation in real time. You can always access your device with the same domain name no matter how much your device IP address changes. Before making any changes, check whether your device supports the DNS server.



- The third party servers might collect your device information if DDNS is enabled.
- Register and log in to the DDNS website, and then you can view the information of all the connected cameras in your account.

Step 1 Select **Setting** > **Network** > **DDNS**.

Figure 5-42 DDNS

Step 2 Select **Type**, and then configure the parameters as needed.

Table 5-15 DDNS parameter description

Parameter	Description
Type	The name and website of the DDNS service provider. Here is the matching relationship.
Server Address	<ul style="list-style-type: none"> • CN99 DDNS Server address: www.3322.org • NO-IP DDNS Server address: dynupdate.no-ip.com • Dyndns DDNS Server address: members.dyndns.org
Domain Name	The domain name you registered on the DDNS website.
Username	Enter the username and password obtained from DDNS service provider. You need to register an account (including username and password) on the website of DDNS service provider.
Password	
Interval	The update cycle of the connection between your device and the server, and the time is 10 minutes by default.

Step 3 Click **Save**.

Open the browser, enter the domain name in the address bar, and then press the Enter key. The login interface is displayed.

5.2.5 SMTP (Email)



After this function is enabled, the device data will be sent to the given server. There is data leakage risk. Think twice before enabling the function.

After you configure **SMTP (Email)**, when alarms, video detection and abnormal events are triggered, an email will be sent to the recipient server through SMTP server. The recipient can log in to the incoming mail server to receive emails.

Step 1 Select **Setting > Network > SMTP (Email)**.

Figure 5-43 SMTP (Email)

SMTP(Email)

SMTP Server

Port

Anonymity

Username

Password

Sender

Authentication ▼

Title Attachment

Mail Receiver +
-


Health Mail Update Period s(1~3600)

Step 2 Configure parameters as needed.

Table 5-16 SMTP (Email) parameter description


Parameter	Description
SMTP Server	IP address of the outgoing mail server complying with SMTP protocol.
Port	Port number of the outgoing mail server complying with SMTP protocol. It is 25 by default.
Username	Username of sender mailbox.
Password	Password of sender mailbox.
Anonymity	For servers supporting anonymous email, you can log in anonymously without entering username, password, and sender information.
Sender	Email address of the sender.


For the detailed configuration, see Table 5-17.

Parameter	Description
Authentication	Select authentication type from None , SSL and TLS . TLS is selected by default.  <ul style="list-style-type: none"> For the detailed configuration, see Table 5-17. There might be risks if you select the authentication type other than TLS. TLS is recommended.
Title	You can enter no more than 63 characters in Chinese, English, and Arabic numerals.
Mail Receiver	Email address of the receiver. Support 3 addresses at most.
Attachment	Select the check box to support attachment in the email.
Health Mail	The system sends test mail to check if the connection is successfully configured. Select the Health Mail check box and configure the Update Period , and then the system sends test mails according to the defined period.
Test	Test whether the email function is normal. If the configuration is correct, the email address of the receiver will receive the test email. Save the email configuration before running rest.

For common email configurations, see Table 5-17.

Table 5-17 Common email configuration description

Type	SMTP Server	Authentication	Port	Description
QQ	smtp.qq.com	SSL	465	<ul style="list-style-type: none"> The authentication type cannot be None. You need to enable SMTP service in your mailbox. The authentication code is required; either the QQ password or email password is not applicable.  Authentication code is the code you receive when enabling SMTP service.
		TLS	587	
163	smtp.163.com	SSL	465/994	<ul style="list-style-type: none"> You need to enable SMTP service in your
		TLS	25	

Type	SMTP Server	Authentication	Port	Description
		—		mailbox. <ul style="list-style-type: none"> The authentication code is required; the email password is not applicable.  Authentication code is the code you receive when enabling SMTP service.
Sina	smtp.sina.com	SSL	465	You need to enable SMTP service in your mailbox.
		—	25	
126	smtp.126.com	—	25	You need to enable SMTP service in your mailbox.

Step 3 Click **Save**.

5.2.6 UPnP



After UPnP is enabled, Intranet service and port of the Device will be mapped to Extranet. Think twice before enabling it.

UPnP (Universal Plug and Play) allows you to establish the mapping relationship between Intranet and Extranet. Extranet users can access Intranet device by visiting Extranet IP address. Intranet port is device port and Extranet port is router port. Users can access the Device by accessing Extranet port. When you are not using routers for UPnP, disable UPnP to avoid affecting other functions.

Once UPnP is enabled, the Device supports UPnP protocol. In Windows XP or Windows Vista, after UPnP is enabled, the Device can be automatically searched by Windows network.

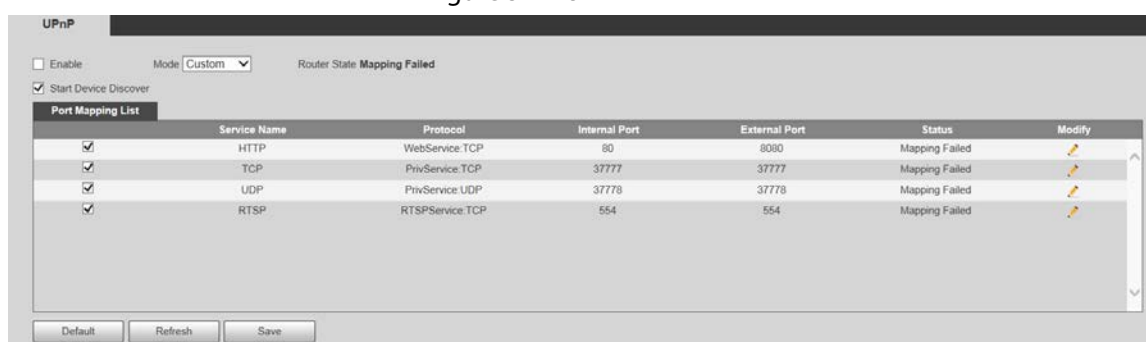
Adding UPnP Network Service in Windows System

1. Open **Control Panel**, and then select **Add or Remove Programs**.
2. Click **Add/Remove Windows Components**.
3. Select **Network Service** from the **Windows Components Wizard** and click **Details** button.
4. Select **Internet Gateway Device Discovery and Control Client**, and **UPnP User Interface**, and then click **OK** to start installation.

Configuring UPnP

1. Select **Setting > Network > UPnP**.

Figure 5-44 UPnP



2. Select **Enable**.
3. Select a mode from the drop-down list.
There are 2 mapping modes: **Custom** and **Default**.
 - In **Custom** mode, users can modify the external port.
 - Select **Default**, and then the system finishes mapping with unoccupied port automatically. In this case, you do not need to modify mapping relation.
4. Select **Start Device Discover** as needed.
5. Click **Save**.

5.2.7 Bonjour

Introduction

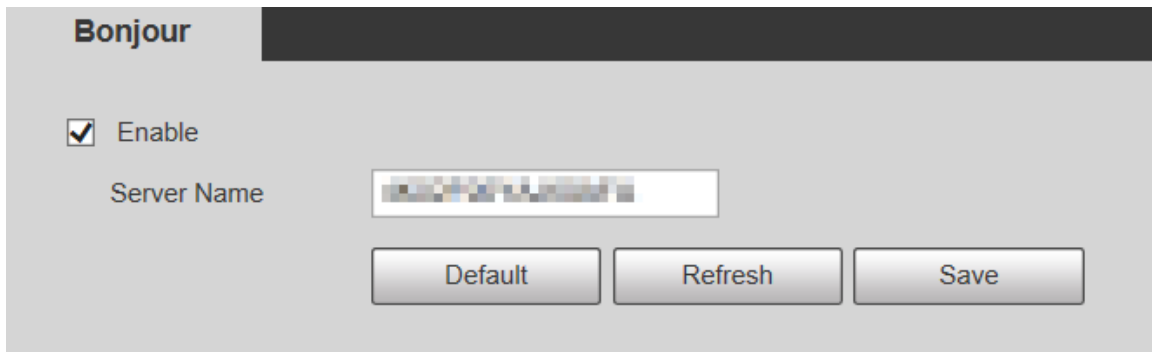
Bonjour is also called zero-configuration networking, which can automatically discover computers, devices and services on IP networks. Bonjour is a protocol of industry standard which allows devices to search and find each other. IP address or DNS server is not required during the process.

Enable this function, and the network camera will be automatically detected by the OS and client with Bonjour function. When the network camera is automatically detected by Bonjour, server name you have set will be displayed.

Configuring Bonjour

1. Select **Setting > Network > Bonjour**.

Figure 5-45 Bonjour interface



2. Select **Enable**, and then set **Server Name**.
3. Click **Save**.

Visiting Web Interface with Safari Browser

In the OS and clients that support Bonjour, perform the following steps to visit the web interface of the Device with Safari browser.

1. Click **Show all bookmarks** in Safari.
2. The OS or client automatically detects the network cameras with Bonjour enabled in the LAN.
3. Click to visit the corresponding web interface.

5.2.8 SNMP

After setting SNMP (Simple Network Management Protocol) and connecting to the Device through certain software (such as MIB Builder and MG-SOFT MIB Browser), you can manage and monitor the Device with the software.

Prerequisites

- Install SNMP monitoring and management tool such as MIB Builder and MG-SOFT MIB Browser.
- Get the MIB file of the matched version from technical support.

Procedure

- Step 1 Select **Setting > Network > SNMP**.

Figure 5-46 SNMP (1)

The interface shows the following configuration:

- Version: v1, v2, v3 (Recommen...)
- SNMP Port: (1~65535)
- Read Community:
- Write Community:
- Trap Address:
- Trap Port:
- Keep Alive

Buttons: Default, Refresh, Save

Figure 5-47 SNMP (2)

The interface shows the following configuration:

- Version: v1, v2, v3 (Recommen...)
- SNMP Port: (1~65535)
- Read Community:
- Write Community:
- Trap Address:
- Trap Port:
- Keep Alive
- Read-only Username:
- Authentication Type: MD5, SHA
- Authentication Pass...:
- Encryption Type: CBC-DES
- Encryption Password:
- Read&write Userna...:
- Authentication Type: MD5, SHA
- Authentication Pass...:
- Encryption Type: CBC-DES
- Encryption Password:

Buttons: Default, Refresh, Save

Step 2 Select SNMP version to enable SNMP.

- Select **V1**, and the system can only process information of V1 version.
- Select **V2**, and the system can only process information of V2 version.
- Select **V3**, and then **V1** and **V2** become unavailable. You can configure username, password and authentication type. It requires corresponding username, password and




authentication type to access your device from the server.



Using **V1** and **V2** might cause data leakage, and **V3** is recommended.

In **Trap Address**, enter the IP address of the PC that has MIB Builder and MG-SOFT MIB Browser installed, and leave other parameters to the default.

Table 5-18 Description of SNMP parameters

Parameter	Description
SNMP Port	The listening port of the software agent on the Device.
Read Community, Write Community	The read and write community string that the software agent supports.  The name must consist of numbers, letters, underlines and strikethroughs.
Trap Address	The target address of the Trap information sent by the software agent on the Device.
Trap Port	The target port of the Trap information sent by the software agent on the Device.
Keep Alive	After you select the check box, the Device can send data packet to ensure continuous network connection.
Read-only Username	Set the read-only username used to access the Device, and it is public by default.  The name must consist of numbers, letters or underlines.
Read/Write Username	Set the read/write username used to access the Device, and it is public by default.  The name must consist of numbers, letters or underlines.
Authentication Type	You can select MD5 or SHA . The default type is MD5 .
Authentication Password	It cannot be less than 8 digits.
Encryption Type	It is CBC-DES by default.
Encryption Password	It cannot be less than 8 digits.

Step 3 Click **Save**.

Result

View device configuration through MIB Builder or MG-SOFT MIB Browser.

1. Run MIB Builder and MG-SOFT MIB Browser.
2. Compile the two MIB files with MIB Builder.
3. Load the generated modules with MG-SOFT MIB Browser.
4. Enter the IP address of the Device you need to manage in the MG-SOFT MIB Browser, and then select version to search.
5. Unfold all the tree lists displayed in the MG-SOFT MIB Browser, and then you can view the configuration information, video channel amount, audio channel amount, and software version.



Use PC with Windows OS and disable SNMP Trap service. The MG-SOFT MIB Browser will display prompt when an alarm is triggered.

5.2.9 Multicast

You can access the Device by network to see live view. If the access times exceed its upper limit, preview might fail. You can set multicast IP to access by multicast protocol to solve the problem. The Device supports two multicast protocols: **RTP** and **TS**. RTP is enabled by default when main stream and sub stream are used. TS is disabled by default.

5.2.9.1 RTP

Step 1 Select **Setting > Network > Multicast > RTP**.

Figure 5-48 RTP interface

Step 2 Enable main stream or sub stream as needed.

Step 3 Enter multicast address and port number.

Step 4 Click **Save**.

5.2.9.2 TS

Step 1 Select **Setting > Network > Multicast > TS**.

Figure 5-49 TS interface

Step 2 Enable main stream or sub stream as needed.

Step 3 Enter multicast address and port number.

Step 4 Click **Save**.

5.2.10 Auto Register

After you enable this function, when the Device is connected to Internet, it will report the current location to the specified server which acts as the transit to make it easier for the client software to access the Device.

Step 1 Select **Setting > Network > Auto Register**.

Figure 5-50 Auto register

Step 2 Select the **Enable** check box to enable **Auto Register**.

Step 3 Enter **IP Address**, **Port** and **Sub-Device ID**.

Table 5-19 Auto register parameter description

Parameter	Description
IP Address	The IP address of server that needs to be registered to.
Port	The port for auto-registration.
Sub-Device ID	Sub device ID assigned by server.

Step 4 Click **Save**.

5.2.11 Wi-Fi

Devices with Wi-Fi function can access network through Wi-Fi.



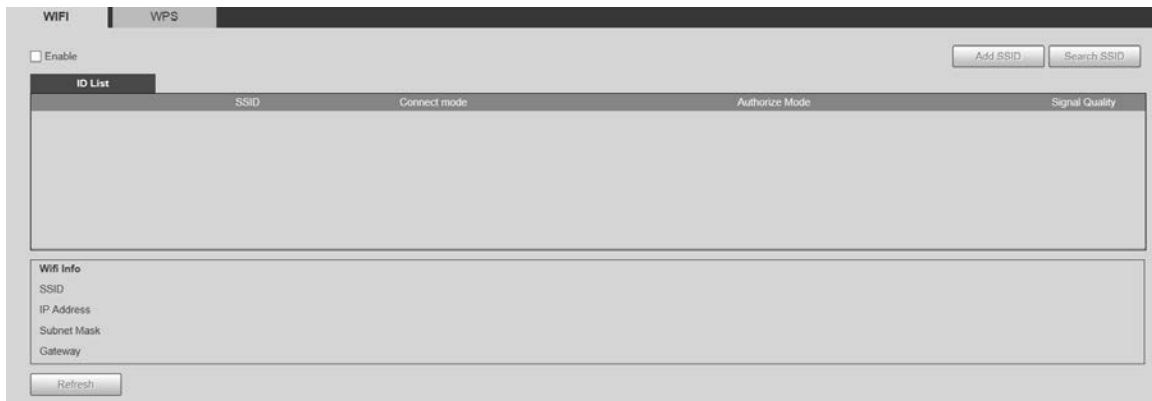
- Wi-Fi and WPS are available on select models.
- All devices with WPS button support WPS function.

5.2.11.1 Wi-Fi Settings

The name, status and IP information of current hotspot are displayed in the Wi-Fi information bar. Click **Refresh** after reconnection to make sure that the operating status is displayed in real time. Connecting Wi-Fi hotspot takes some time depending on network signal strength.

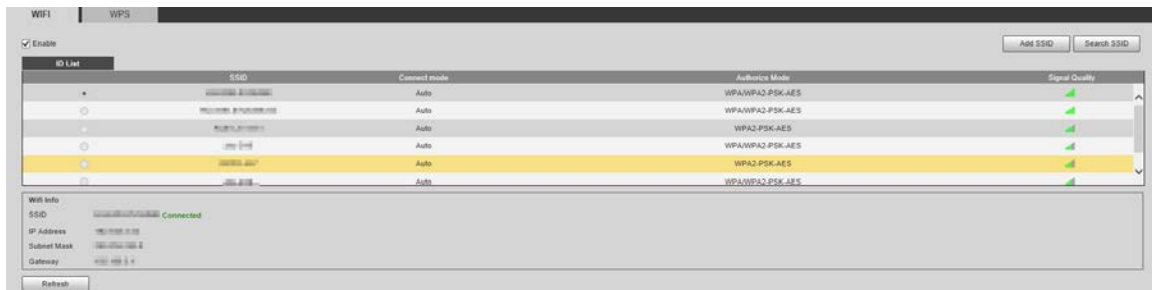
Step 1 Select the **Enable** check box.

Figure 5-51 Wi-Fi settings (1)



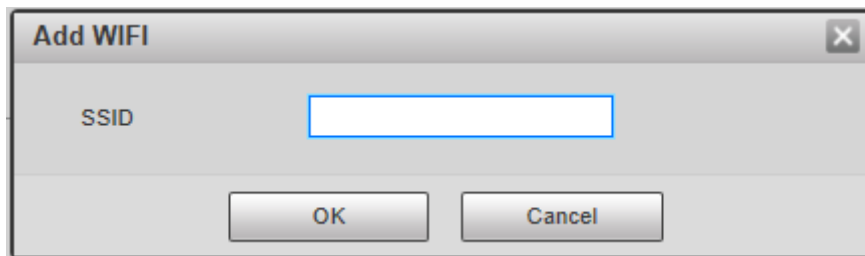
Step 2 Click **Search SSID**, and Wi-Fi hotspots in the environment of current network camera are displayed.

Figure 5-52 Wi-Fi settings (2)



Step 3 To manually add Wi-Fi, click **Add SSID**, and the **Add WiFi** interface is displayed.

Figure 5-53 Add Wi-Fi



Step 4 Enter a network name in the dialog box.



It is recommended to set a secure encryption method for the Device to connect routers.

Step 5 Double-click one hotspot to display the **Signal Quality** and the **Authentication Manner**.

- If the password is required, enter it. When entering the password, its index number shall be consistent with that on the router.
- Click **Connection** if password is not required.

5.2.11.2 WPS Settings

Figure 5-54 WPS settings

PIN and SSID can be obtained from the router. Enter PIN and SSID, and then click **Refresh** to display operating status in real time.

5.2.11.3 AP Settings

You can use the Camera as wireless AP (Access Point), and other devices such as mobile phones can connect to the Camera by searching for the network name. You can then log in to the Camera through the browser on your device. At most 5 accounts can log in to the Camera at the same time. AP and Wi-Fi cannot be both enabled at the same time, and AP is disabled by default.

Procedure

- Step 1 Select **Setting > Network > WIFI > AP**.
- Step 2 Select **Enable**, and then set AP information.

Figure 5-55 AP settings

Table 5-20 AP parameter description

Parameter	Description
SSID	The default name is "device serial number_SD".
Frequency Band	Both 2.4G and 5G are available.
Verification Type	It is WPA2 PSK by default, and cannot be changed.
Connection Password	Set the connection password which is required when other devices connect to the Camera. It is 12345678 by default.

Parameter	Description
Host IP	Displays the IP address of AP.

Step 3 Click **Save**.

Result

1. Open your device such as mobile phone, search for the network name of the AP in the wireless signal list, and then connect to the network.
After it is successfully connected, the IP address and MAC address of the device is displayed on the **AP** interface.
2. Open a browser on your device, enter the host IP on the **AP** interface or IP address on the **TCP/IP** interface, and then you can go to the login interface of the Camera.
3. Enter the username and password, and then log in to the Camera.



Live view is available on select devices.

5.2.12 802.1x

802.1x is a port-based network access control protocol. It allows users to manually select authentication mode to control device access to LAN, and meet authentication, billing, safety and management requirements of the network.

Step 1 Select **Setting > Network > 802.1x**.

Figure 5-56 802.1x interface

Step 2 Select the **Enable** check box to enable **802.1x**.

Step 3 Select an authentication mode, and enter username and password.

Table 5-21 802.1x setting parameter description

Parameter	Description
Authentication	PEAP (protected EAP protocol).
Username	The username that was authenticated on the server.
Password	Corresponding password.

Step 4 Click **Save**.

5.2.13 QoS

QoS (Quality of Service) is a network security mechanism, and is also a technology to solve network delay, congestion, and other problems.

For network business, QoS includes transmission bandwidth, time delay in transmission, and packet loss of data. In network, QoS can be improved by ensuring transmission bandwidth, and reducing time delay in transmission, packet loss rate, and delay jitter.

For DSCP (Differentiated Services Code Point), there are 64 priority degrees (0–63) of data packets. 0 represents the lowest priority, and 63 the highest priority. Based on the priority, the packets are classified into different groups. Each group occupies different bandwidth and has different discard percentage when there is congestion so as to improve service quality.

Step 1 Select **Setting > Network > QoS**.

Figure 5-57 QoS interface

Step 2 Configure parameters.

Table 5-22 QoS setting parameter description

Parameter	Description
Realtime Monitor	Data packet of network video monitoring. The value ranges from 0 to 63.
Command	Data packet of device configuration and query. The value ranges from 0 to 63.
Open the WMM	Select the check box to enable wireless QoS.

Step 3 Click **Save**.

5.2.14 4G/5G

After installing SIM card, you can connect the Device to 4G/5G network through dialing or mobile setting.

- Dialing setting: Connect the Device to 4G/5G network in specified period.
- Mobile setting: Receive alarm linkage messages on your mobile phone. When receiving alarm messages, you can activate the Device to connect to 4G/5G network through SMS or phone calls.



- The function is available on devices with 4G/5G module. This section takes 4G as an example.
- Dual 4G is supported by select models, but only one 4G network adapter can be enabled simultaneously.

5.2.14.1 Dialing Setting

Log in to web interface, select **Setting > Network > 4G > Dialing Setting**, and the **Dialing Setting** interface is displayed.

Figure 5-58 Dialing setting interface



Some devices only support certain mobile carriers, and only the supported carriers are displayed in **Network Support**.

- Step 1** Select the **Enable** check box.
- Step 2** Enter **APN**, **Authorize Mode**, **Dial-up Number**, **Username**, and **Password** according to the SIM card inserted.



These parameters might vary by countries. Contact local carrier or customer service for details.

- Step 3** Set the period to use 4G.



- If the current time is in the period you set, 4G network connection will be enabled. The IP address of the SIM card will be displayed in IP Address. And you can access the device through 4G after finishing the rest steps.
- If the current time is not in the period you set, 4G network connection will not be enabled. Only the corresponding **Wireless Signal** is displayed on the interface. And you cannot access the device through 4G.

Figure 5-59 Period setting

Step 4 Set the interval to enable 4G through message or phone call if you want to use 4G outside the period set in [Step3](#).



The value range is 0–7200 s and it is 30 s by default. If the interval is 30 s, after activating 4G, you can use it for 30 s. After 30 s, you need to activate 4G again. If you set the interval to 0 s, you can use 4G without disconnection and you do not need to activate it again. For the method to activate 4G through message or phone call, see "5.2.14.2 Mobile Setting".

Step 5 Click **Save**.

5.2.14.2 Mobile Setting

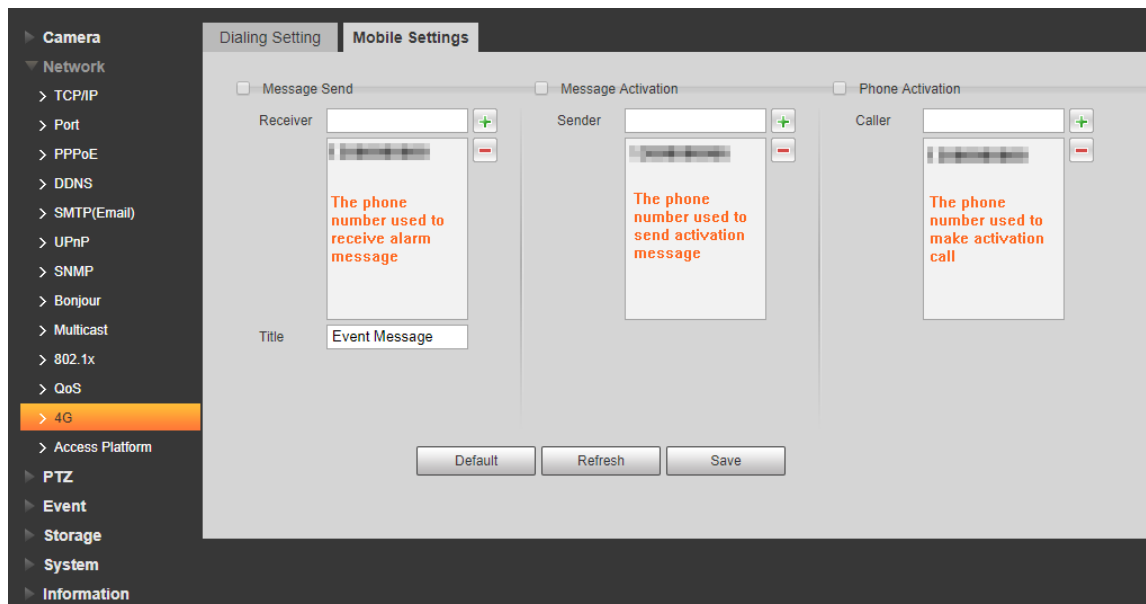
Log in to web interface, select **Setting > Network > 4G > Mobile Settings**, and the **Mobile Setting** interface is displayed.

You can add the phone number to receive alarms. You also can add phone number used to activate 4G through message or phone call if you want to use 4G outside the period set in [Step3](#) of "5.2.14.1 Dialing Setting".



Make sure that you add international calling codes before the phone number to avoid unnecessary charges caused by phone calls or messages to other countries or regions.

Figure 5-60 Mobile setting interface




- **Message Send:** When alarms are triggered, the phone number added will receive message.
- **Message Activation:** You can enable 4G through message outside the period you set to use 4G. You need to send "ON" or "OFF" to phone number of the SIM card in the Device. "ON" indicates enabling, and "OFF" indicates disabling.
- **Phone Activation:** You can enable 4G through phone calls outside the period you set to use 4G. You need to call the phone number of the SIM card in the Device. If the call gets through, it means 4G has been enabled.



- Make sure that your SIM card supports making phone calls and sending messages, and it can be used normally.
- Make sure that you use activation function outside the time range you set; otherwise it does not work.

Step 1 Select the check box of the service you need to enable. You can select one or more services.

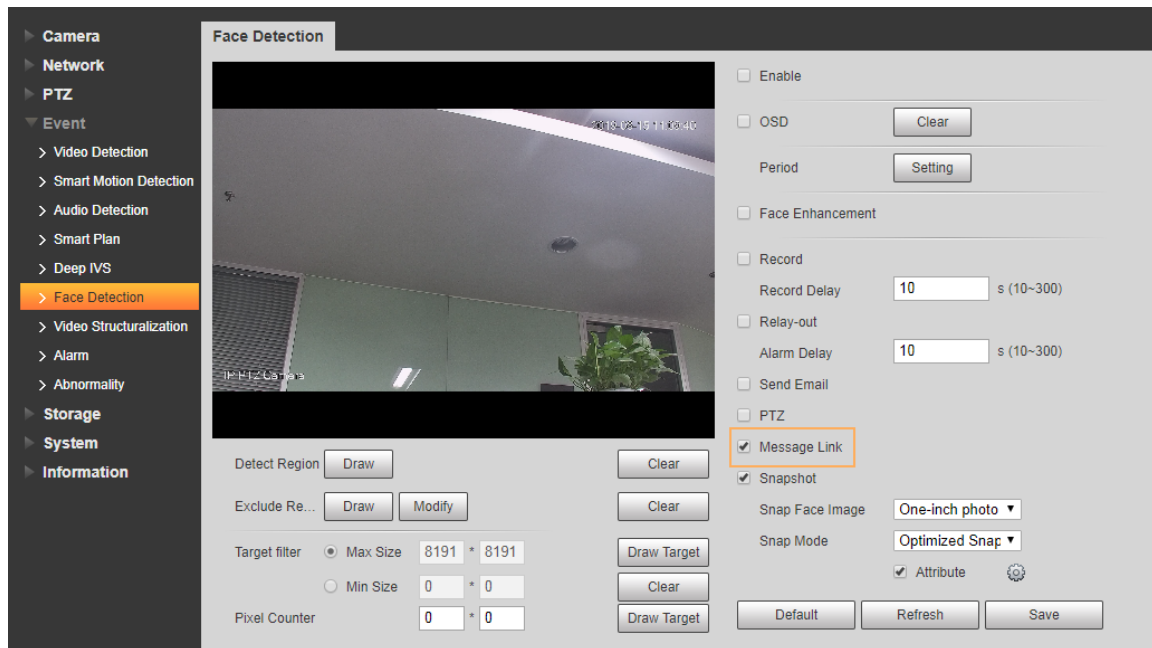
Step 2 Enter the phone number and click  to add it.

Step 3 Click **Save**.

Step 4 Select the **Message Link** check box on the interface of the event for which you want to receive message.

Take Face Detection for example. Click **Setting** > **Event** > **Face Detection** and select the **Message Link** check box.

Figure 5-61 Message link



Step 5 Click **Save** on the interface of the corresponding event. And you will receive message if the alarm is triggered.

5.2.15 Access Platform

5.2.15.1 P2P

P2P is a private network traversal technology which enables users to manage devices easily without requiring DDNS, port mapping or transit server. Scan the QR code with your smart phone, and then you can add and manage more devices on your mobile client.

Step 1 Select **Setting > Network > Access Platform > P2P**.

Figure 5-62 P2P interface



- P2P is enabled by default. You can manage the devices remotely.
- When P2P is enabled and the device is connected to network, the status is displayed as **Online**. We might collect the information including IP address, MAC address, device name, and serial number. The information collected is for remote access only. If you do not agree with this, you can clear the **Enable** check box.

Step 2 Log in to mobile phone client and tap **Device Management**.

Step 3 Tap **Add +** at the upper-right corner.

Step 4 Scan the QR code on the P2P interface.

Step 5 Follow the onscreen instructions to finish settings.

5.2.15.2 ONVIF

The ONVIF authentication is **On** by default, which allows the network video products (including video recording device and other recording devices) from other manufacturers to connect to the service.

Step 1 Select **Setting > Network > Access Platform > ONVIF**.

Figure 5-63 ONVIF interface



Step 2 Select **On** for **Authentication**.

Step 3 Click **Save**.

5.2.15.3 RTMP

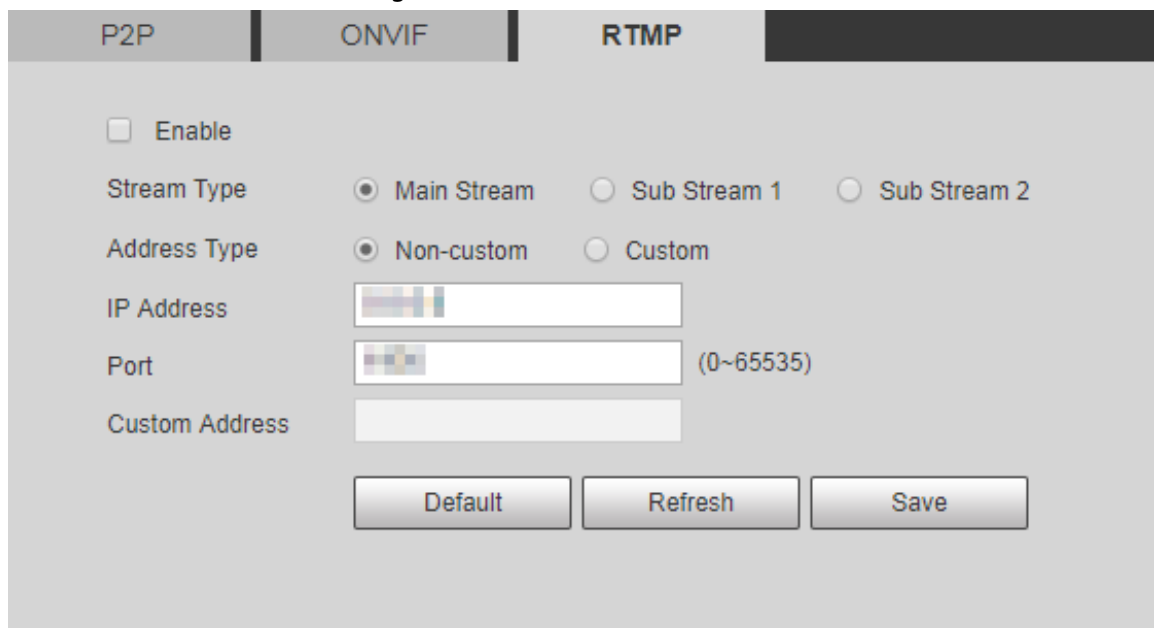
You can connect the third party platforms (such as YouTube) to play live video through RTMP protocol.



- Only admin user can configure RTMP.
- RTMP only supports H.264, H.264B and H.264H video formats, and Advanced Audio Coding (AAC) audio format.

Step 1 Select **Setting > Network > Access Platform > RTMP**.

Figure 5-64 RTMP interface



Step 2 Select the **Enable** check box, and RTMP will be enabled.



When enabling RTMP, make sure that the address can be trusted.

Step 3 Set parameters.

Table 5-23 RTMP parameter setting description

Parameter	Description
Stream Type	Select live video stream type. Make sure that the video format of the stream is H.264, H.264B or H.264H, and the audio format is AAC.
Address Type	There are two options: Non-custom and Custom . <ul style="list-style-type: none"> • Non-custom: You need to fill in the IP address or domain name. • Custom: You need to fill in the address allocated by the server.
IP Address	If you have selected Non-custom , IP address and port need to be filled in. <ul style="list-style-type: none"> • IP Address: IPv4 or domain name is supported. • Port: It is recommended to use the default value.
Port	
Custom Address	If you have selected Custom , the address allocated by the server needs to be filled in.

Step 4 Click **Save**.

5.3 Bluetooth Settings

You can connect the Camera to Bluetooth devices such as Bluetooth headset for voice broadcast of alarms and voice intercom with the platform.



The function is available on select models.

Procedure

Step 1 Select **Setting** > **Connection Settings** > **Bluetooth**.

Step 2 Select **Enable**.

The searched Bluetooth devices are displayed in the **Bluetooth List**. Click **Refresh** at the lower-right corner of the list to search for **Bluetooth** devices again.

Figure 5-65 Bluetooth list



Step 3 Double-click the name of Bluetooth device, and then set PIN on the **Setup** interface.



For the PIN of the Bluetooth device, see the corresponding user's manual.

Figure 5-66 Connect to Bluetooth device

Step 4 Click **Save**.

The connected Bluetooth device is displayed in the list below.

Step 5 Select **Setting > Camera > Audio > Audio**, and then set audio input and audio output types to **Bluetooth**.

Figure 5-67 Set audio

Related Operations

- Click **Refresh** at the lower-right corner of the list to get information of paired Bluetooth devices again.

- Click **Pair Again** to quickly connect to Bluetooth devices paired before.
- Click **Delete** to delete the Bluetooth device.

5.4 PTZ Settings

5.4.1 Protocol

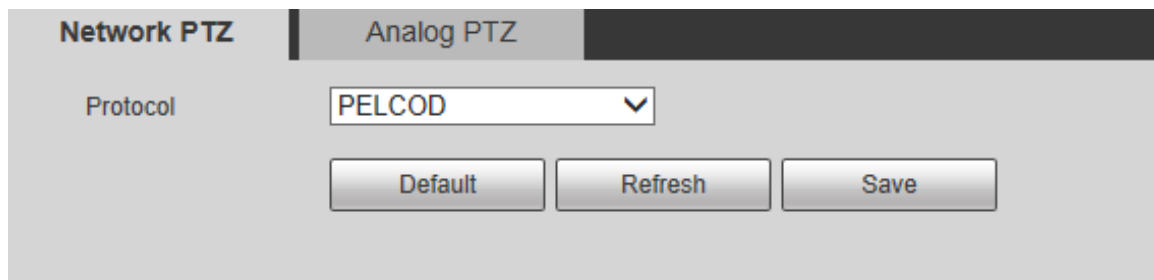


Network PTZ setting and analog PTZ setting are available on select models.

5.4.1.1 Network PTZ Settings

Step 1 Select **Setting > PTZ > Protocol > Network PTZ**.

Figure 5-68 Network PTZ setting



Step 2 Select a protocol as needed.

You can select **DH-SD1**, **DH-SD3**, **PELCOD**, or **PELCOP**. **DH-SD1** is selected by default.



DH-SD1 protocol supports up to 80 presets, and DH-SD3 protocol supports up to 300 presets.

Step 3 Click **Save**.

5.4.1.2 Analog PTZ Settings

Step 1 Select **Setting > PTZ > Protocol > Analog PTZ**.


Figure 5-69 Analog PTZ setting

Parameter	Value
Address	1
Baud Rate	9600
Data Bit	8
Stop Bit	1
Parity	NONE

Buttons: Default, Refresh, Save

Step 2 Configure parameters as needed.

Table 5-24 Analog PTZ parameter description

Parameter	Description
Address	Enter the address of the Device.  Make sure that the address is the same as the device address; otherwise you cannot control the device.
Baud Rate	Select the baud rate of the Device.
Data Bit	It is 8 by default.
Stop Bit	It is 1 by default.
Parity	It is NONE by default.

Step 3 Click **Save**.

5.4.2 Function

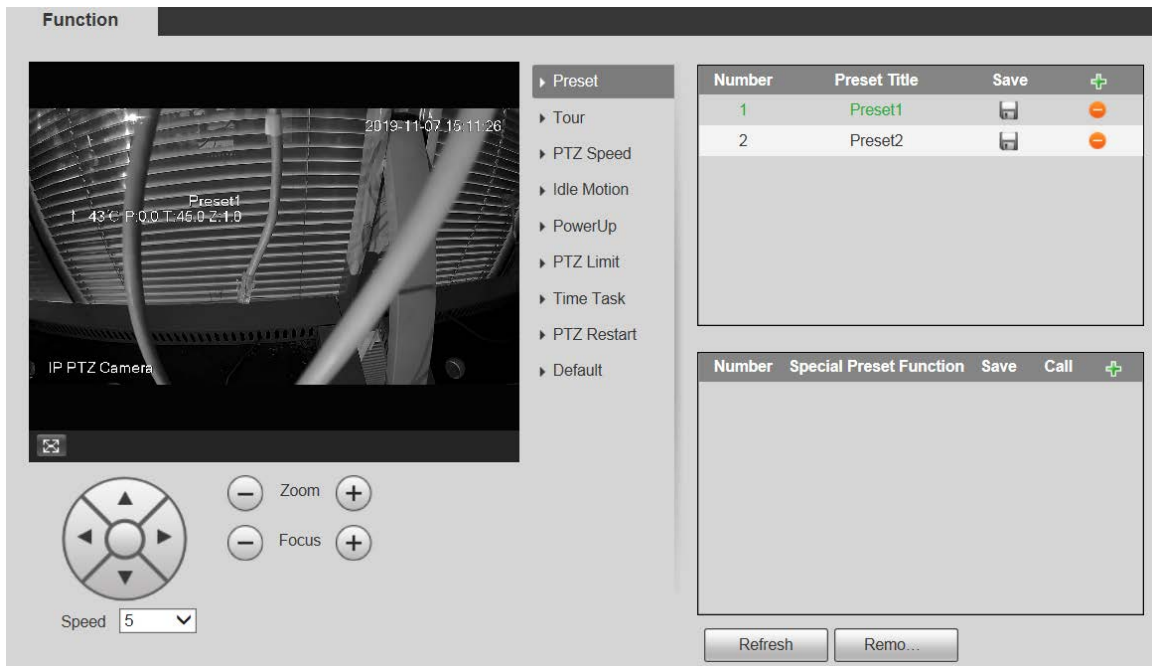
5.4.2.1 Preset

Select **Setting** > **PTZ** > **Function** > **Preset**. The **Preset** interface is displayed.



If you click **Remove All**, all presets and special presets will be cleared.

Figure 5-70 Preset



5.4.2.1.1 Preset Settings

Preset means a certain position to which the Device rotates. Users can adjust the PTZ and camera to the location quickly through calling presets.

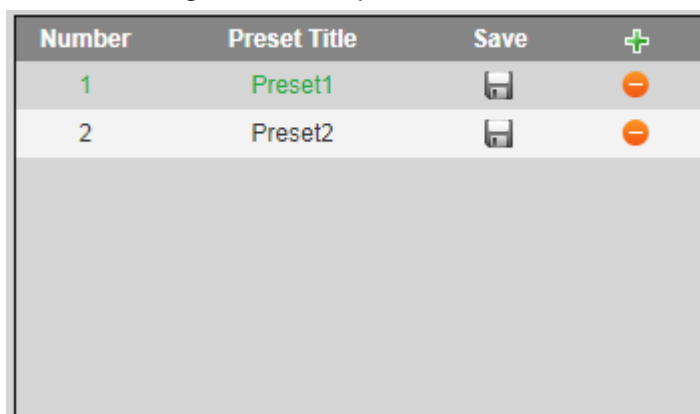
Step 1 At the lower left corner of the **Preset** interface, click the direction buttons, ,

, and to adjust the PTZ direction, speed, zoom, and focus of the Device.

Step 2 Click to add a preset.

The current position is set to a preset and is displayed in the list.

Figure 5-71 Add presets



Step 3 Click to save the preset.

Step 4 Perform operations on presets.

- Double-click the preset title to edit the title displayed on the monitoring screen.
- Click to delete the preset.

5.4.2.1.2 Special Preset Settings

Special presets serve as the shortcut for some special functions switch or calling, and they no longer represent the location of the PTZ camera.

Step 1 Click to add a special preset. The added special preset will be displayed in the list.



The number of special presets starts from 51 by default, and 100 is the largest number.

Figure 5-72 Special presets

Number	Special Preset Function	Save	Call	
51	Day/Night B&V			
52	Day/Night Colc			

Step 2 Click to save the added special preset.

Step 3 Perform operations on special presets.



If the PTZ is restored to default settings, all preset configurations will be cleared, but the called function will remain.

Related Operations

- Click to modify the special preset function.
- Click to delete the special preset.
- Click to quickly call the function configured for the special preset.

5.4.2.2 Tour

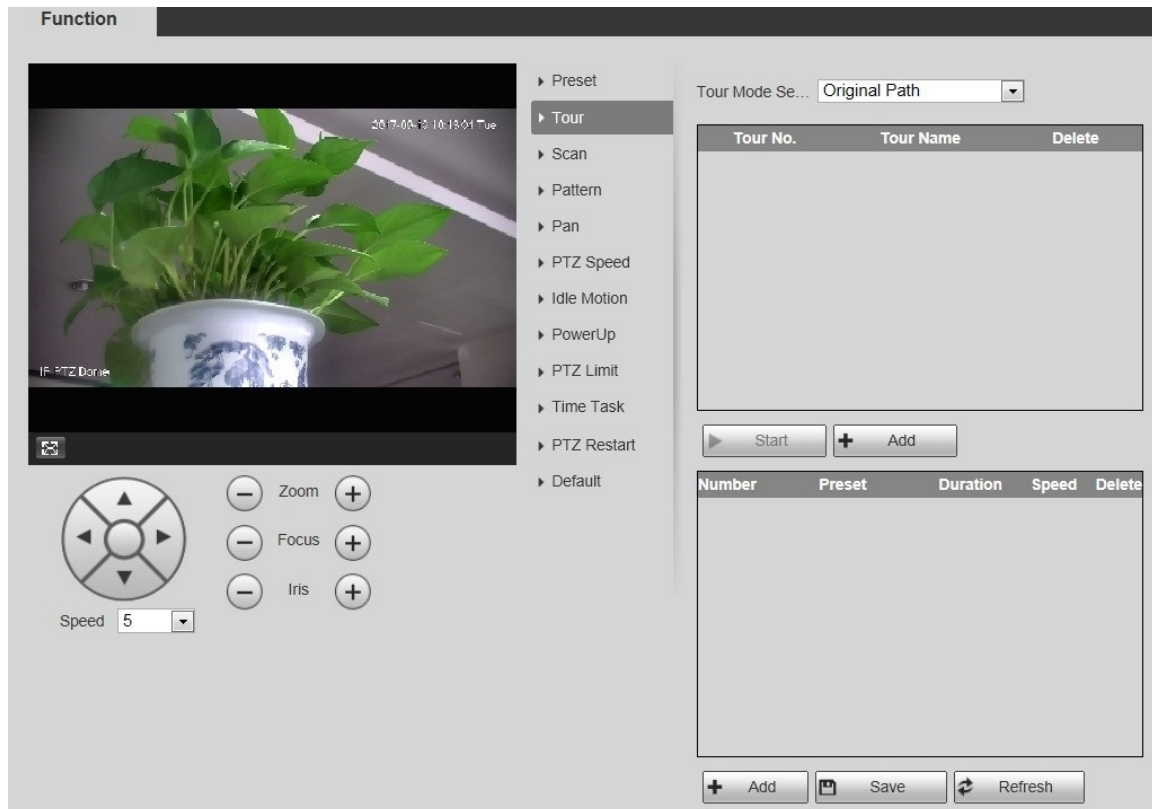
Tour means a series of movements that the Device makes along several presets.



You need to set several presets in advance.

Step 1 Select **Setting > PTZ > Function > Tour**.

Figure 5-73 Tour settings



Step 2 Select the **Tour Mode** from **Original Path** and **Shortest Path**. **Original Path** is selected by default.

- Original Path: Tour in the order of adding presets.
- Shortest Path: Starting from the preset with largest horizontal zoom value and vertical zoom value, pass all presets in the tour to ensure the shortest path. The Device reaches the corresponding preset and ensure the minimum number of rotation.

Step 3 Click **Add** at the bottom of the list at the upper right corner of the interface to add a tour path.

Step 4 Click **Add** at the bottom of the list at the lower right corner of the interface to add several presets.

Step 5 Perform tour operations.

- Double-click tour name to edit the name of the corresponding tour.
- Double-click duration to set the time that the Device stays at the corresponding preset.
- Double-click speed to modify the tour speed. The default value is 7, and the value range is 1–10. The larger the value, the faster the speed.

Step 6 Click **Start** to start the tour.



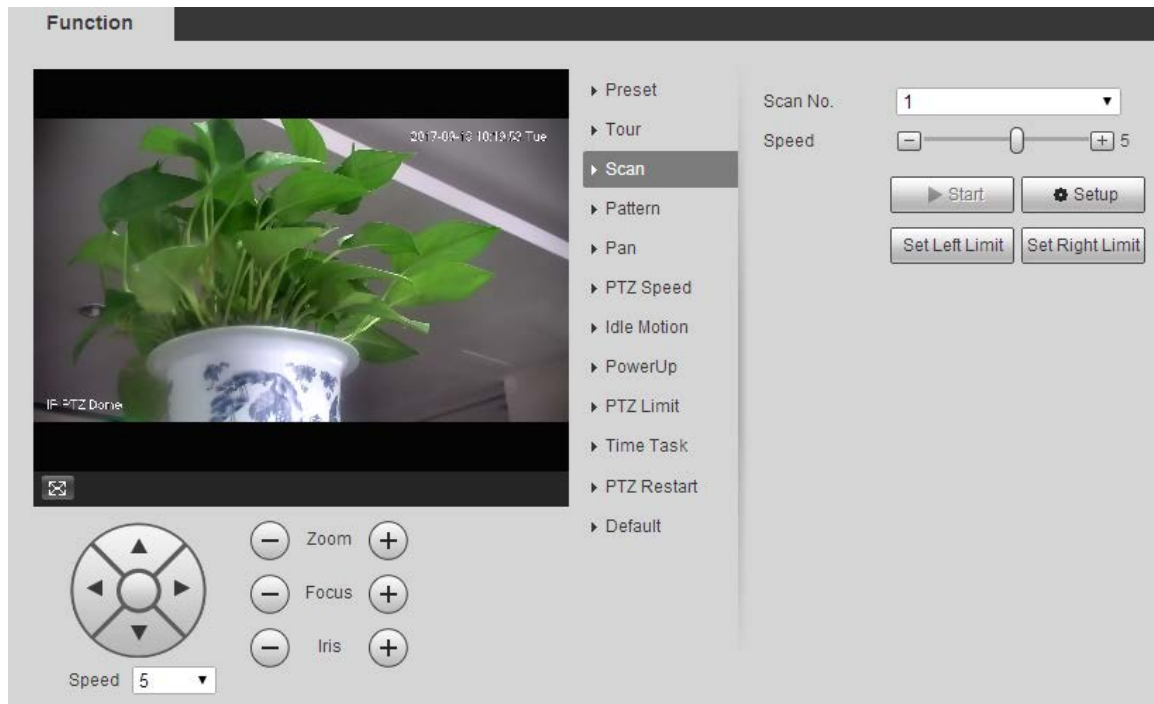
The ongoing tour stops if any operation is made to the PTZ.

5.4.2.3 Scan

Scan means the Device moves horizontally at a certain speed between the defined left and right limits.

Step 1 Select **Setting > PTZ > Function > Scan**.

Figure 5-74 Scan settings



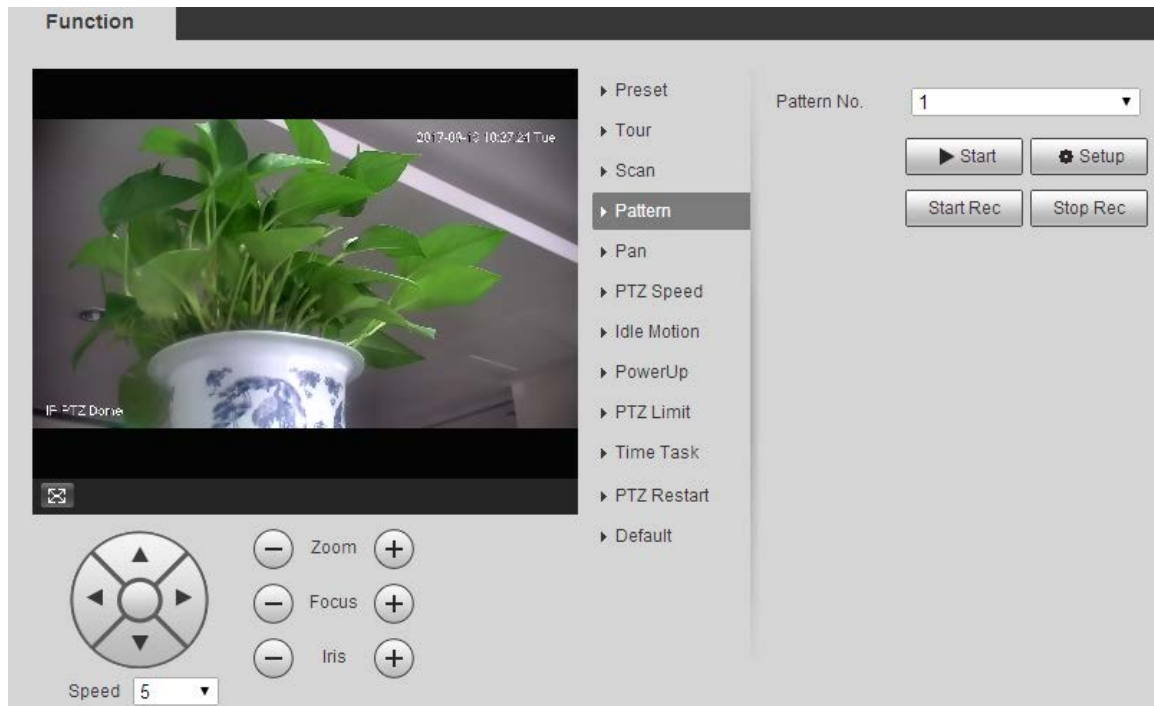
- Step 2** Select the **Scan No.**
- Step 3** Drag the slider to adjust the scan speed.
- Step 4** Click **Setup** to adjust the Device to an ideal position.
- Step 5** Click **Set Left Limit** and **Set Right Limit** to set the left and right boundaries of the Device.
- Step 6** Click **Start**, and the Device starts scanning.
- Step 7** Click **Stop**, and the scanning stops.

5.4.2.4 Pattern

Pattern means a record of a series of operations that users make to the Device. The operations include horizontal and vertical movements, zoom and preset calling. Record and save the operations, and then you can call the pattern path directly.

- Step 1** Select **Setting > PTZ > Function > Pattern**.

Figure 5-75 Pattern settings



Step 2 Select the **Pattern No.**

Step 3 Click **Setup** and **Start Rec**, and then operate the PTZ as needed.

Step 4 Click **Stop Rec** to stop recording.

Step 5 Click **Start**, and the Device starts patterning.

Step 6 Click **Stop**, and the patterning stops.

5.4.2.5 Pan

Pan refers to the continuous 360° rotation of the Device at a certain speed.

Step 1 Select **Setting > PTZ > Function > Pan**.

Figure 5-76 Pan settings



Step 2 Drag the slider to set the **Pan Speed**.

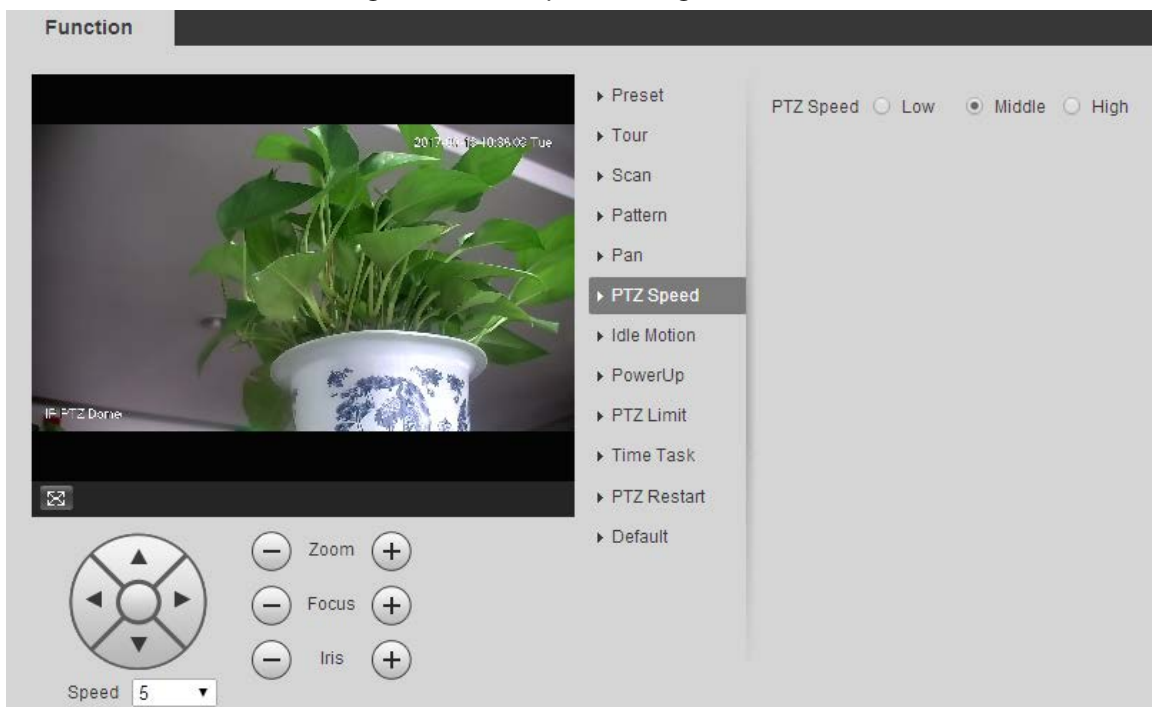
Step 3 Click **Start**, and the Device starts to rotate horizontally at this speed.

5.4.2.6 PTZ Speed

You can adjust the manual control speed of the PTZ by setting PTZ speed. This speed does not apply to tour, pattern, or auto tracking.

Step 1 Select **Setting > PTZ > Function > PTZ Speed**.

Figure 5-77 PTZ speed settings



Step 2 Select **Low, Middle or High**.

5.4.2.7 Idle Motion

Idle motion refers to a set motion when the Device does not receive any valid command within a certain period.



Set **Preset, Tour, Scan** or **Pattern** in advance.

Step 1 Select **Setting > PTZ > Function > Idle Motion**.

Figure 5-78 Idle motion settings



Step 2 Select the **Enable** check box to enable the idle motion.

Step 3 Select idle motion from **Preset, Tour, Scan** and **Pattern**.

Step 4 Select the action number of the selected motion.

Step 5 Set **Idle Time** for the selected motion.

Step 6 Click **Save**.

5.4.2.8 PowerUp

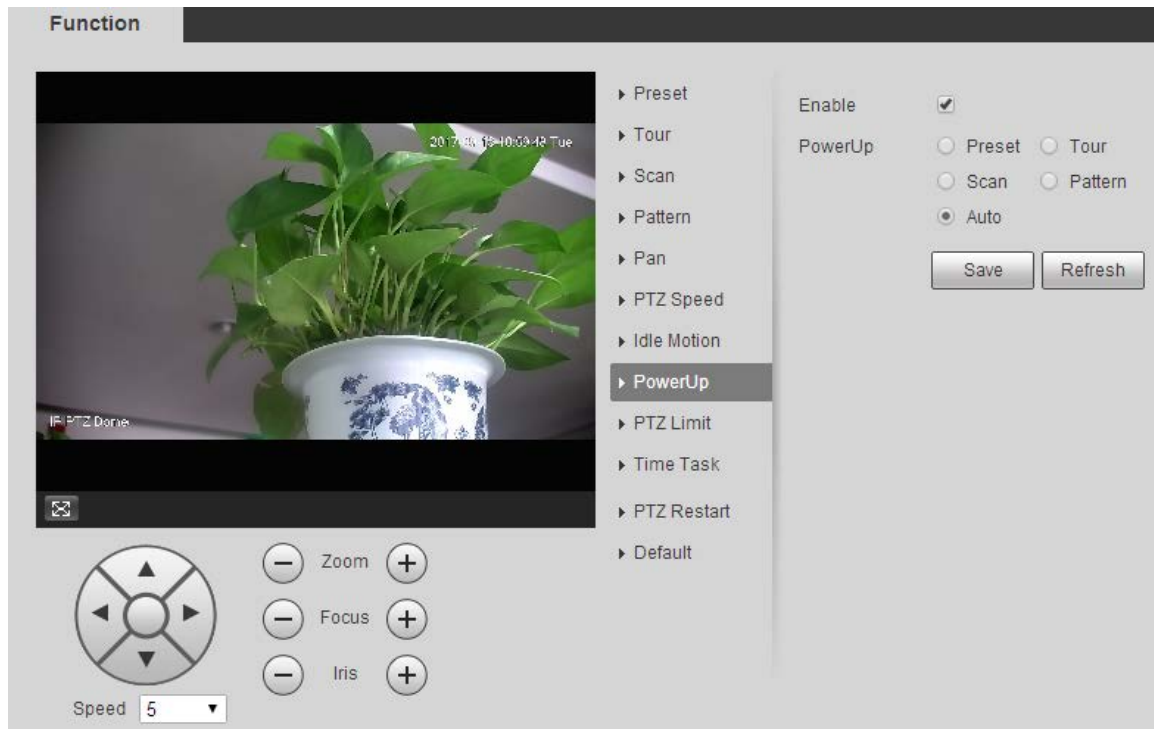
PowerUp means the automatic operation of the Device after it is powered on.



Set **Preset, Tour, Scan** or **Pattern** in advance.

Step 1 Select **Setting > PTZ > Function > PowerUp**.

Figure 5-79 PowerUp settings



Step 2 Select the **Enable** check box to enable power up motion.

Step 3 Select power up motion from **Preset, Tour, Scan, Pattern** or **Auto**.



Select **Auto** and the last motion before you shut down the Device last time will be performed.

Step 4 Select the action number of the selected motion.

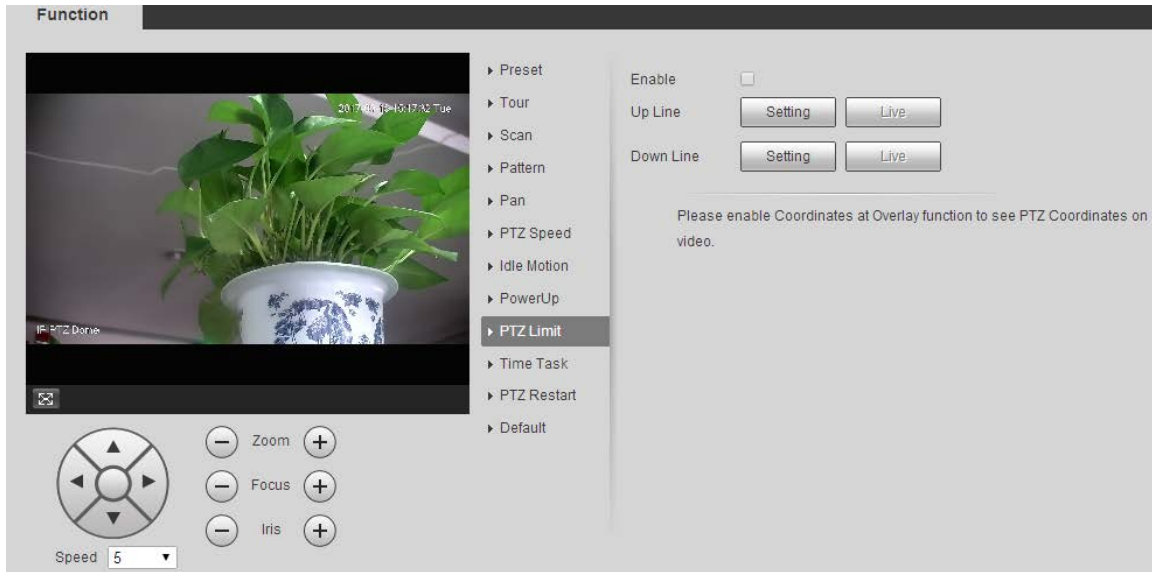
Step 5 Click **Save**.

5.4.2.9 PTZ Limit

After you set the PTZ limit, the Device can only move in the defined area.

Step 1 Select **Setting > PTZ > Function > PTZ Limit**.

Figure 5-80 PTZ limit settings



- Step 2** Adjust the PTZ direction and click **Setting** to set the **Up Line**.
- Step 3** Adjust the PTZ direction and click **Setting** to set the **Down Line**.
- Step 4** Click **Live** to preview the already-set up line and down line.
- Step 5** Select the **Enable** check box to enable the PTZ limit function.

5.4.2.10 Time Task

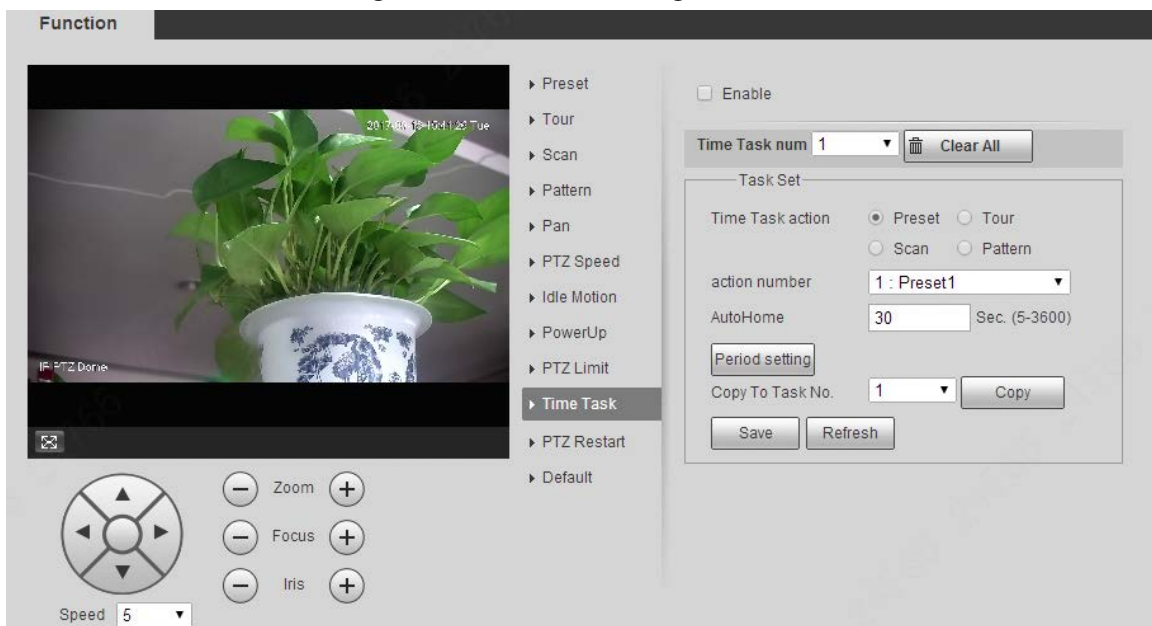
After you set time task, the Device performs the selected motions during the defined period.



Set **Preset**, **Tour**, **Scan** or **Pattern** in advance.

- Step 1** Select **Setting** > **PTZ** > **Function** > **Time Task**.

Figure 5-81 Time task settings



- Step 2** Select the **Enable** check box to enable time task function.
- Step 3** Set the time task number.



Click **Clear All** to delete all set time tasks.

Step 4 Select **Time Task** action such as **Preset, Tour, Scan** or **Pattern**.

Step 5 Select the action number of the selected motion.

Step 6 Set the time for **AutoHome**.



AutoHome refers to the time needed to automatically recover the time task in case of manually calling the PTZ to stop the time task.

Step 7 Click **Period setting** to set the period to perform time tasks.

Step 8 Select the task number to copy settings to the selected task, and then click **Copy**.

Step 9 Click **Save**.

5.4.2.11 PTZ Restart

Step 1 Select **Setting > PTZ > Function > PTZ Restart**.

Figure 5-82 PTZ restart



Step 2 Click **PTZ Restart**.

The PTZ is restarted.

5.4.2.12 Default

With the function, you can restore the PTZ to factory defaults.



This function will restore the Device to defaults. Think twice before performing the operation.

Step 1 Select **Setting > PTZ > Function > Default**.

Figure 5-83 Default setting



Step 2 Click **Default**.

The PTZ will be restored to factory defaults.

5.5 Event Management

5.5.1 Video Detection

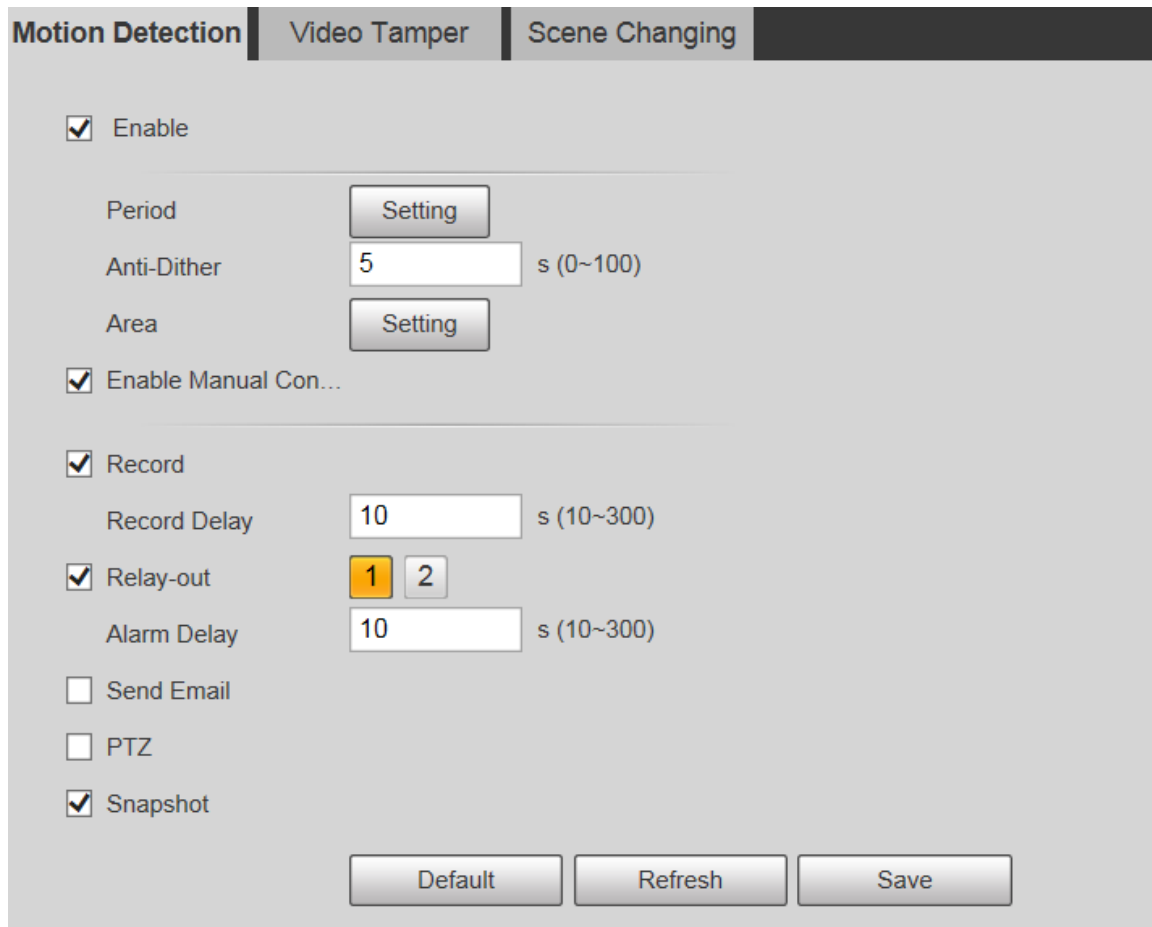
Video detection includes three event types: **Motion Detection**, **Video Tamper** and **Scene Changing**.

5.5.1.1 Motion Detection

When the moving object appears and moves fast enough to reach the preset sensitivity value, alarms will be triggered.

Step 1 Select **Setting > Event > Video Detection > Motion Detection**.

Figure 5-84 Motion detection settings



Enable

Period

Anti-Dither s (0~100)

Area

Enable Manual Con...

Record

Record Delay s (10~300)

Relay-out

Alarm Delay s (10~300)

Send Email

PTZ

Snapshot

Step 2 Select the **Enable** check box, and then configure parameters as needed.

- Set arming and disarming period.
 1. Click **Setting**, and then set the arming period on the interface.

Figure 5-85 Arming period settings

2. Set the alarm period to enable alarm events in the period you set.
 - ◇ There are 6 time periods for each day. Select the check box for the time period to enable it.
 - ◇ Select the day of week (**Sunday** is selected by default; If **All** is selected, the setting is applied to the whole week. You can also select the check box next to the day to set it separately).
3. After completing the settings, click **Save**.

You will return to the **Motion Detection** interface.
- Set the area.

Click **Setting**, and the **Area** interface is displayed. See Figure 5-86. Refer to Table 5-25 and Table 5-26 for parameters description. Each color represents a certain region, and you can set different motion detection regions for each area. The detection region can be irregular and discontinuous.

Figure 5-86 Area setting

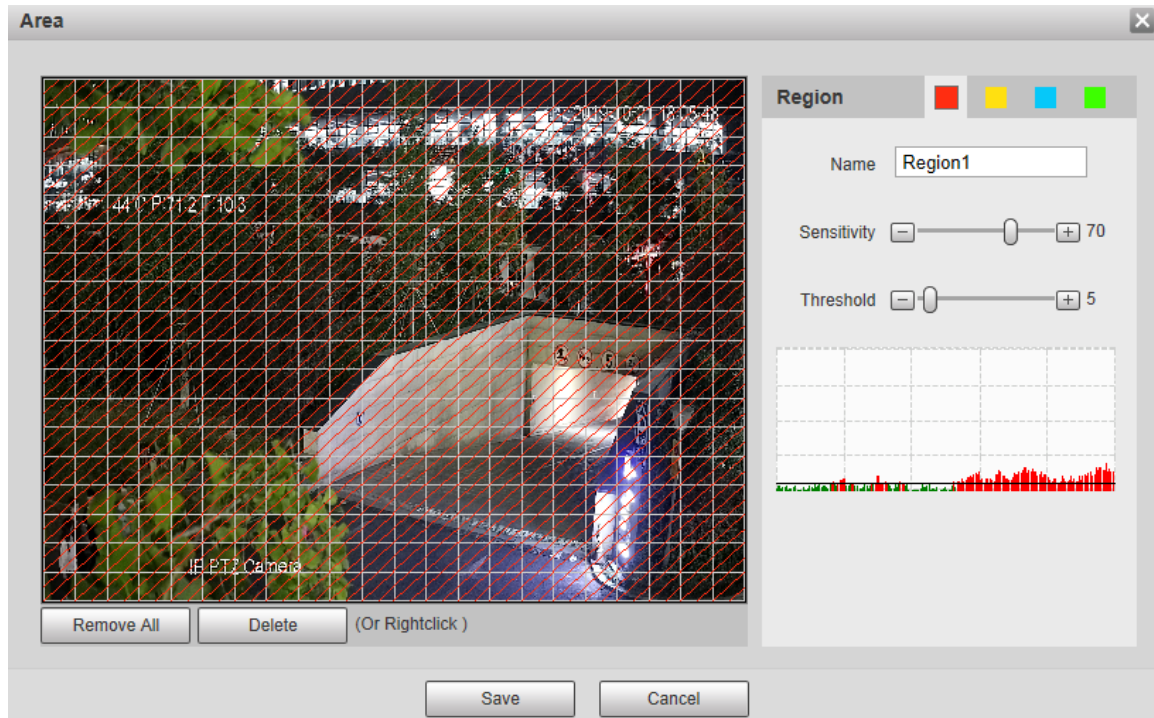


Table 5-25 Area setting parameter description

Parameter	Description
Name	The default names are Region1, Region2, Region3 and Region4, and the names can be customized.
Sensitivity	Sensitivity to brightness change. The higher the sensitivity is, the easier the motion detection event will occur. You can set different sensitivities for each region, with values ranging from 0 to 100, and 30 to 70 is recommended.
Threshold	Detect the relation between the object and the region. The smaller the threshold is, the easier the motion detection will occur. Set different thresholds for each region, with values ranging from 0 to 100, and 1 to 10 is recommended.
Waveform graph	The red line indicates that motion detection is triggered, and the green line indicates that it is not triggered.
Remove All	Remove all detection regions.
Delete	Delete the detection region of the selected color block.

- Other parameters

Table 5-26 Video detection parameter description

Parameter	Description
Anti-Dither	The system records only one motion detection event within the defined period. The value range is 0–100 s.
Enable Manual Control Trigger	After you enable the function, the motion detection events that occur when you control the PTZ manually will be excluded. In this way, you can reduce the false alarm rate of such events.

Parameter	Description
Record	After you enable the function, when an alarm is triggered, the system will start recording automatically. Before using the function, you need to set the recording period of the alarm in Storage > Schedule , and select Auto for Record Mode on the Record Control interface.
Record Delay	When the alarm is over, the alarm recording will continue for an extended period of time. The time unit is second, and the value range is 10–300.
Relay-out	Select the check box, and you can enable the alarm linkage output port, and link corresponding relay-out devices after an alarm is triggered.
Alarm Delay	When the alarm is over, the alarm will continue for an extended period of time. The time unit is second, and the value range is 10–300.
Send Email	After you select the check box, when an alarm is triggered, the system sends email to the specified email address. You can configure the email address in "5.2.5 SMTP (Email)."
PTZ	Select PTZ , and then configure the linkage action. When an alarm is triggered, the system links PTZ to rotate to the preset. The Activation options include None , Preset , Tour and Pattern .
Snapshot	Select the Snapshot check box, and then the system takes snapshot automatically when an alarm is triggered. You need to set the alarm snapshot period as described in "5.5.1.2 Snapshot."

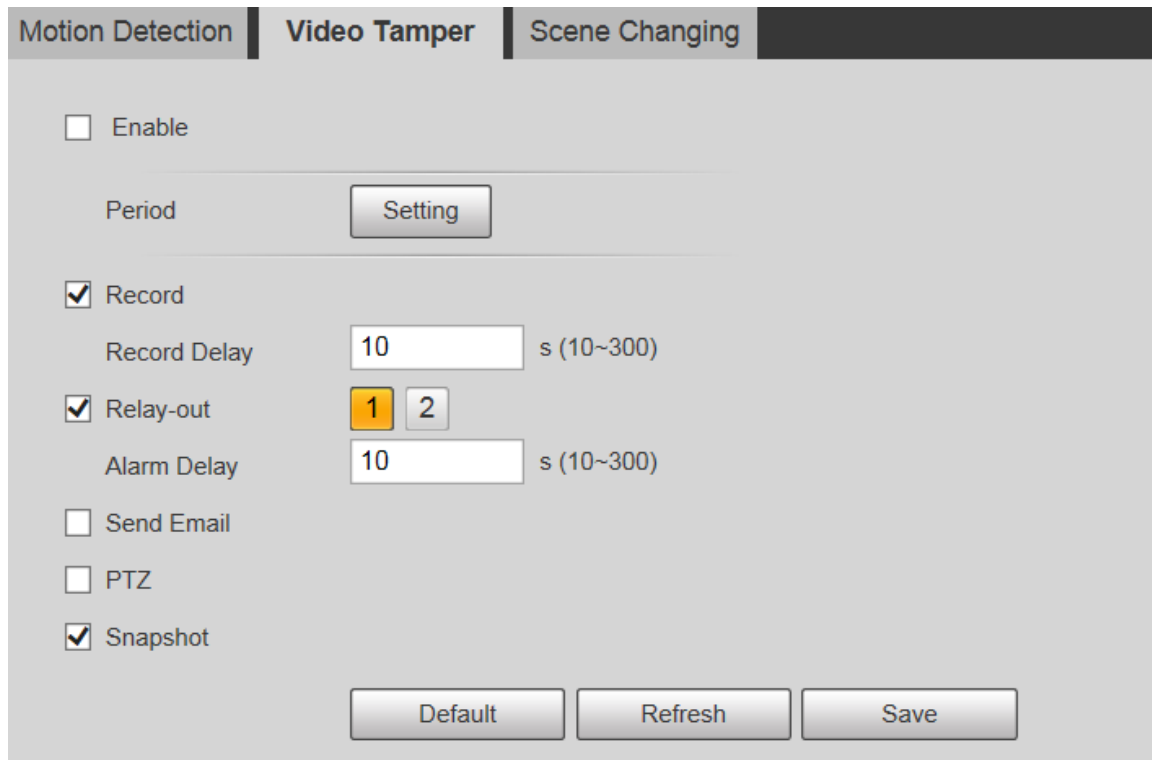
Step 3 Click **Save**.

5.5.1.2 Video Tamper

Alarms will be triggered if there is video tampering.

Step 1 Select **Setting > Event > Video Detection > Video Tamper**.

Figure 5-87 Video tamper settings



Step 2 Select the **Enable** check box, and then configure parameters as needed.



For parameters configuration, see "5.5.1.1 Motion Detection".

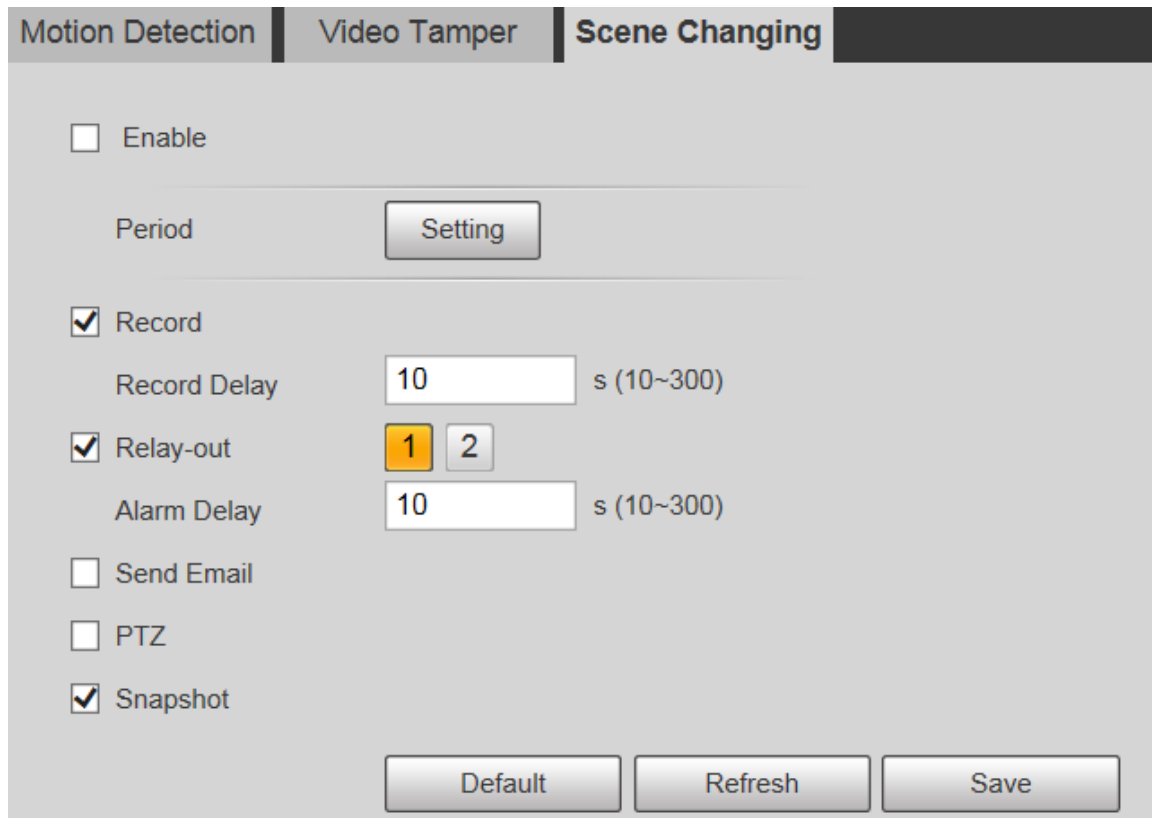
Step 3 Click **Save**.

5.5.1.3 Scene Changing

Alarms will be triggered if there is scene changing.

Step 1 Select **Setting > Event > Video Detection > Scene Changing**.

Figure 5-88 Scene changing settings



Step 2 Select the **Enable** check box, and then configure parameters as needed.



For parameters configuration, see "5.5.1.1 Motion Detection".

Step 3 Click **Save**.

5.5.2 Smart Motion Detection

After you set smart motion detection, when the human, non-motor vehicles and motor vehicles appear and move fast enough to reach the preset sensitivity value, the alarm linkage actions will be performed. The function can help you to avoid the alarms triggered by natural environment change.



- The function depends on the result of motion detection, and all other parameters (except sensitivity) of motion detection function are used, including arming period, area settings, and linkage configurations. If no motion detection is triggered, smart motion detection will not be triggered.
- If motion detection is not enabled, when smart motion detection is enabled, motion detection will also be enabled. If both functions are enabled, when motion detection is disabled, smart motion detection will also be disabled.
- When smart motion detection is triggered and recording is linked, back-end devices can filter recording with human or vehicles through smart search function. For details, see the corresponding user's manual.

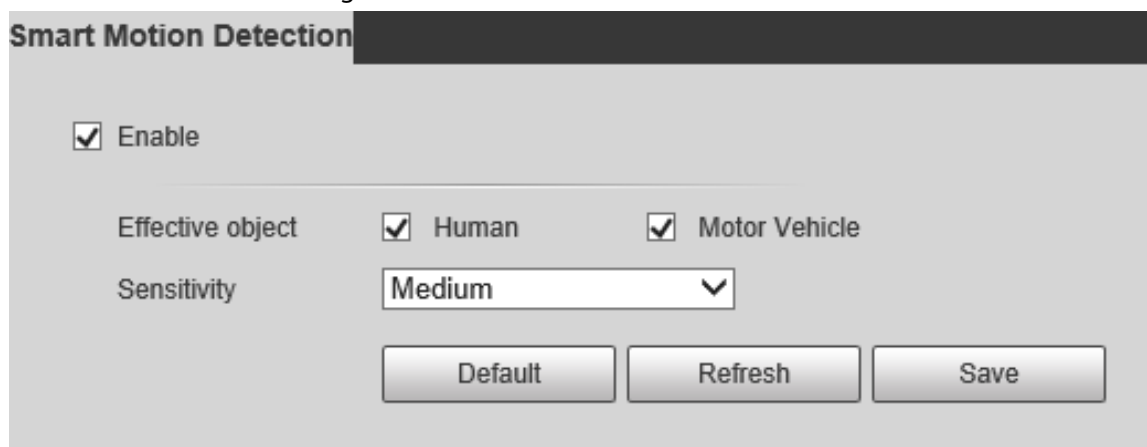
Prerequisites

- Select **Setting > Event > Video Detection > Motion Detection**, and then enable the motion detection function.
- Set the arming period and detection area. The sensitivity of each region is larger than 0, and the threshold is not equal to 100.

Procedure

1. Select **Setting > Event > Smart Motion Detection**.

Figure 5-89 Smart motion detection



2. Select the **Enable** check box, and then the **Smart Motion Detection** is enabled.
3. Select the effective object and sensitivity.
 - **Effective object:** Select **Human** or **Motor Vehicle**. When **Human** is selected, both people and non-motor vehicles will be detected.
 - **Sensitivity:** Select **High**, **Medium**, or **Low**. The higher the sensitivity, the easier the alarm is triggered.
4. Click **Save**.

5.5.3 Audio Detection

- Step 1 Select **Setting > Event > Audio Detection > Audio Detection**.

Figure 5-90 Audio detection settings

Audio Detection

Input Abnormal

Intensity Change

Sensitivity -
-
+
 50

Threshold -
-
+
 50

Period Setting

Anti-Dither s (0~100)

Record

Record Delay s (10~300)

Relay-out

Alarm Delay s (10~300)

Send Email

PTZ

Snapshot

Default
Refresh
Save

Step 2 Configure parameters as needed.

Table 5-27 Audio detection parameter description

Parameter	Description
Input Abnormal	Select Input Abnormal , and then an alarm is triggered when there is abnormal audio input.
Intensity Change	Select Intensity Change , and then an alarm is triggered when the change in sound intensity exceeds the defined threshold.
Sensitivity	The value ranges from 1 to 100. The smaller this value is, the larger the input sound volume changes are needed for it to be judged as an audio anomaly. You need to adjust it according to the actual condition.
Threshold	The value ranges from 1 to 100. Configure the ambient sound intensity you need to filter. The louder the ambient noise is, the larger this value shall be. You need to adjust it according to the actual condition.



For other parameters, see "5.5.1.1 Motion Detection".

Step 3 Click **Save**.

5.5.4 Smart Plan

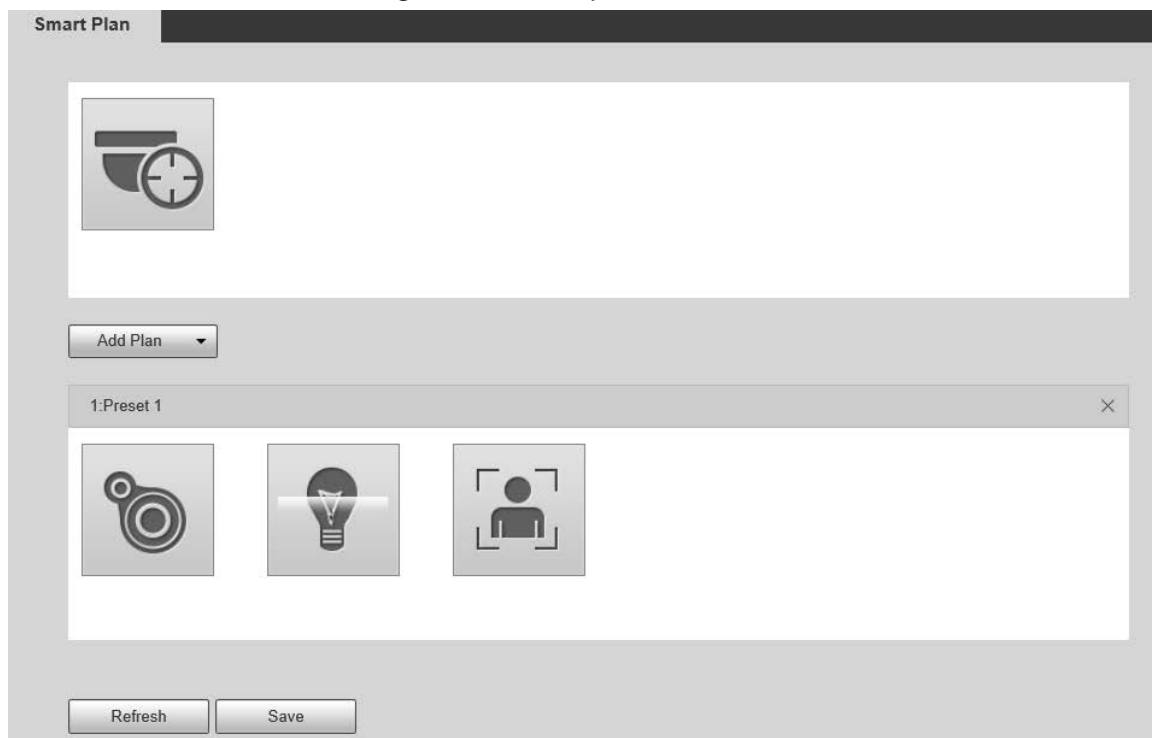
Smart plans include IVS, face recognition, heat map, people counting, video metadata, construction monitoring and so on. Only after smart plans have been enabled, can the corresponding smart function come into effect.



Before configuring the smart plan, you need to set presets in advance. For setting methods, see "5.4.2.1 Preset".

Step 1 Select **Setting > Event > Smart Plan**.

Figure 5-91 Smart plan (1)

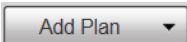


Step 2 (Optional) Click  to enable **Auto Tracking**.

When enabling auto tracking, you do not need to configure smart plans, and the Device performs auto tracking based on internal mechanism. If auto tracking and alarm track of the smart plan (such as IVS) are both enabled, the Device perform tracking in the order of triggering time.



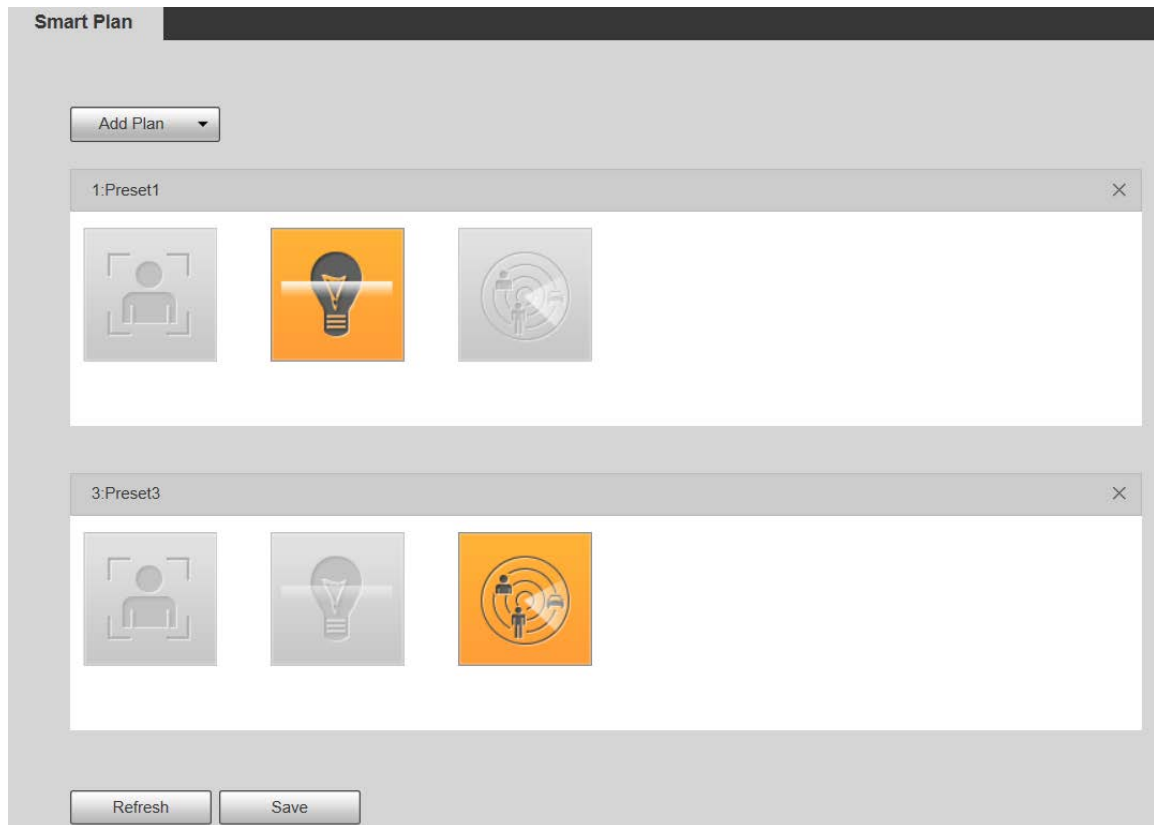
It is recommended to disable auto tracking when alarm track is enabled to avoid disordered tracking.

Step 3 Click  to select the presets to be configured.

Step 4 Select smart plans as needed.

The selected function will be highlighted. Click it again to cancel the selection.

Figure 5-92 Smart plan (2)



Step 5 Click **Save**.

5.5.5 IVS

Basic Requirements for the Scene

- The target size shall not exceed 10% of the image.
- The pixel of the target shall be no less than 10×10; the pixel of abandoned object shall be no less than 15×15 (CIF image); the width and height of the target shall be no more than 1/3 of the image. It is recommended that the height of the target is 10% of the image.
- The brightness difference between the target and the background is no less than 10 gray values.
- The target shall be present in the image for no less than 2 consecutive seconds, and the moving distance shall be larger than its width and no less than 15 pixels (CIF image).
- Try to reduce the complexity of monitoring scenes. It is not recommended to enable IVS in scenes with dense targets and frequent light changes.
- Try to avoid the following scenes: scenes with reflective surfaces such as glass, bright ground or water; scenes that disturbed by tree branches, shadows or winged insects; scenes that against light or under direct light exposure.

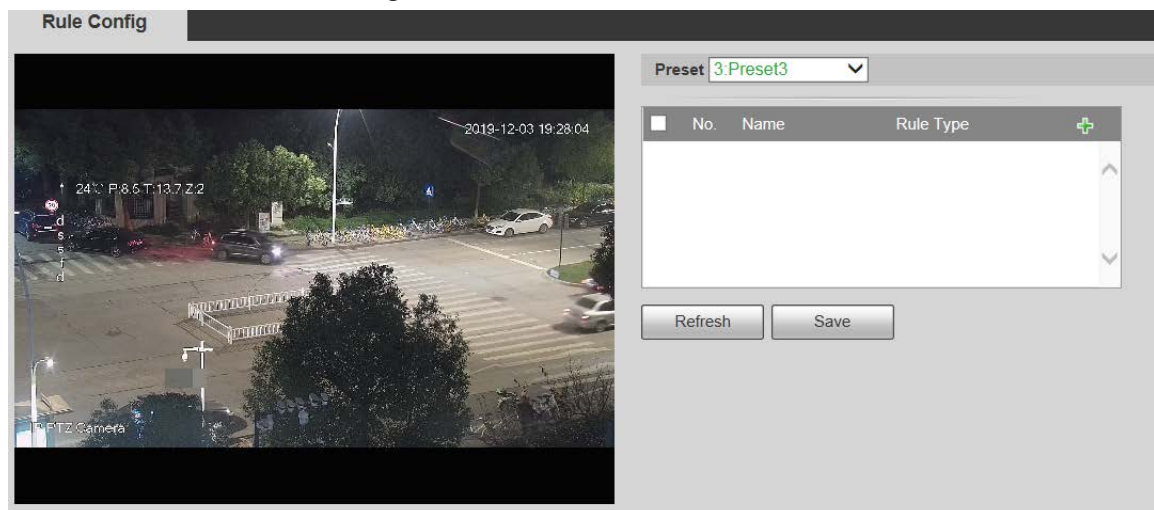


Before using the function, you need to set presets in advance. For setting methods, see "5.3.2.1 Preset."

Rule Config

1. Select **Setting** > **Event** > **IVS** > **Rule Config**.

Figure 5-93 Add smart rules



2. Select the presets to be configured with smart rules.
3. Click to add smart rules.



Double-click rule type to modify the type of rules.

4. Click **Save**.

5.5.5.1 Tripwire

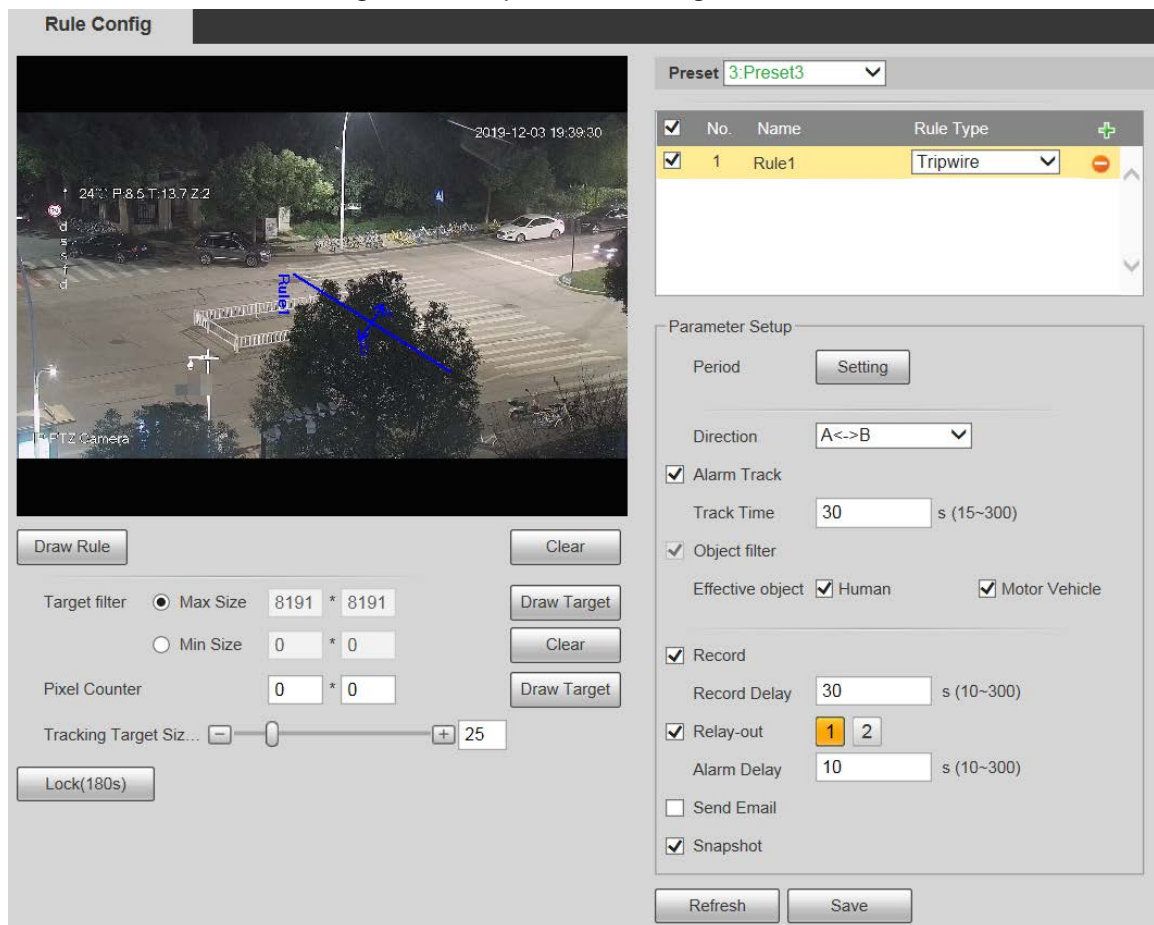
Alarms are triggered when the target crosses the warning line in the defined direction. It requires certain stay time and moving space for the target to be confirmed, so you need to leave some space at both sides of the warning line during configuration and do not draw it near obstacles.

Applicable scenes: Scenes with sparse targets and no occlusion between targets, such as perimeter protection of unattended areas.

Procedure

Step 1 Select **Tripwire** from the **Rule Type** list.

Figure 5-94 Tripwire rule settings




Step 2 Click **Draw Rule**, and you can draw rules on the monitoring screen.



Click **Clear** to the right of **Draw Rule** to clear all drawn rules.

Table 5-28 Rule drawing parameter description

Parameter	Description
Max Size	Set the size range of detection targets to be filtered, and select the

Parameter	Description
Min Size	maximum or minimum size. <ul style="list-style-type: none"> • Max Size: Set the maximum size of targets to be filtered. When the target is larger than this size, the system will ignore it. The unit is pixel. • Min Size: Set the minimum size of targets to be filtered. When the target is smaller than this size, the system will ignore it. The unit is pixel.
Pixel Counter	Help to accurately draw the target area. Enter the length and width of the target area in Pixel Counter , and click Draw Target to generate the target area in the monitoring screen. The unit is pixel.
Lock/Unlock	Enter the rule configuration interface, and the locking function will be automatically enabled, and the locking time is 180 s. During this period, the device cannot track the target. Click Unlock to release the control.  The locking function only takes effect in the rule configuration interface. After switching to the Live interface, the Device can track the target normally.

Step 3 Configure parameters as needed.

Table 5-29 Tripwire parameter description

Parameter	Description
Period	Set the alarming period to enable alarm events in the defined period. <ol style="list-style-type: none"> 1. Click Setting, and then the Period interface is displayed. 2. Enter the time value or press and hold the left mouse button, and drag directly on the setting interface. There are six periods for each day. Select the check box next to the period for it to take effect. 3. Select the day of week (Sunday is selected by default; If All is selected, the setting is applied to the whole week. You can also select the check box next to the day to set it separately). 4. After completing the setting, click Save to go back to the rule configuration interface.
Direction	Configure the tripwire direction. You can select A->B , B->A or A<->B .
Alarm Track	Select the check box, and there will be alarm tracking when a smart rule is triggered.
Track Time	Set the alarm tracking time.
Record	Select the check box, and when an alarm is triggered, the system will start recording automatically. Before using the function, you need to set the recording period of the alarm in Storage > Schedule , and select Auto for Record Mode on the Record Control interface.
Record Delay	When the alarm is over, the recording will continue for an extended period of time. The value range is 10–300 s.
Relay-out	Select the check box, and you can enable the alarm linkage output port, and link corresponding relay-out devices when an alarm is triggered.

Parameter	Description
Alarm Delay	When the alarm is over, the alarm will continue for an extended period of time. The value range is 10–300 s.
Send Email	Select the Send Email check box, and when an alarm is triggered, the system sends an email to the specified mailbox. You can configure the mailbox in Setting > Network > SMTP (Email) .
Snapshot	Select the check box, and the system will automatically take snapshots in case of alarms. You need to set snapshot period in Storage > Schedule .

Step 4 Click **Save**.

5.5.5.2 Intrusion

Intrusion includes crossing areas and in-area functions.

- Crossing area means an alarm will be triggered when a target enters or leaves the area.
- In-area function means an alarm will be triggered when a specified number of targets appear in a set alarming area at a given time. In-area function only counts the number of targets in the detection area, regardless of whether they are the same targets.
- For the reporting time interval of the in-area functions, the system will trigger the first alarm and then detect whether the same event occurs in the interval period. If no same event occurs in this period, the alarm counter will be cleared.

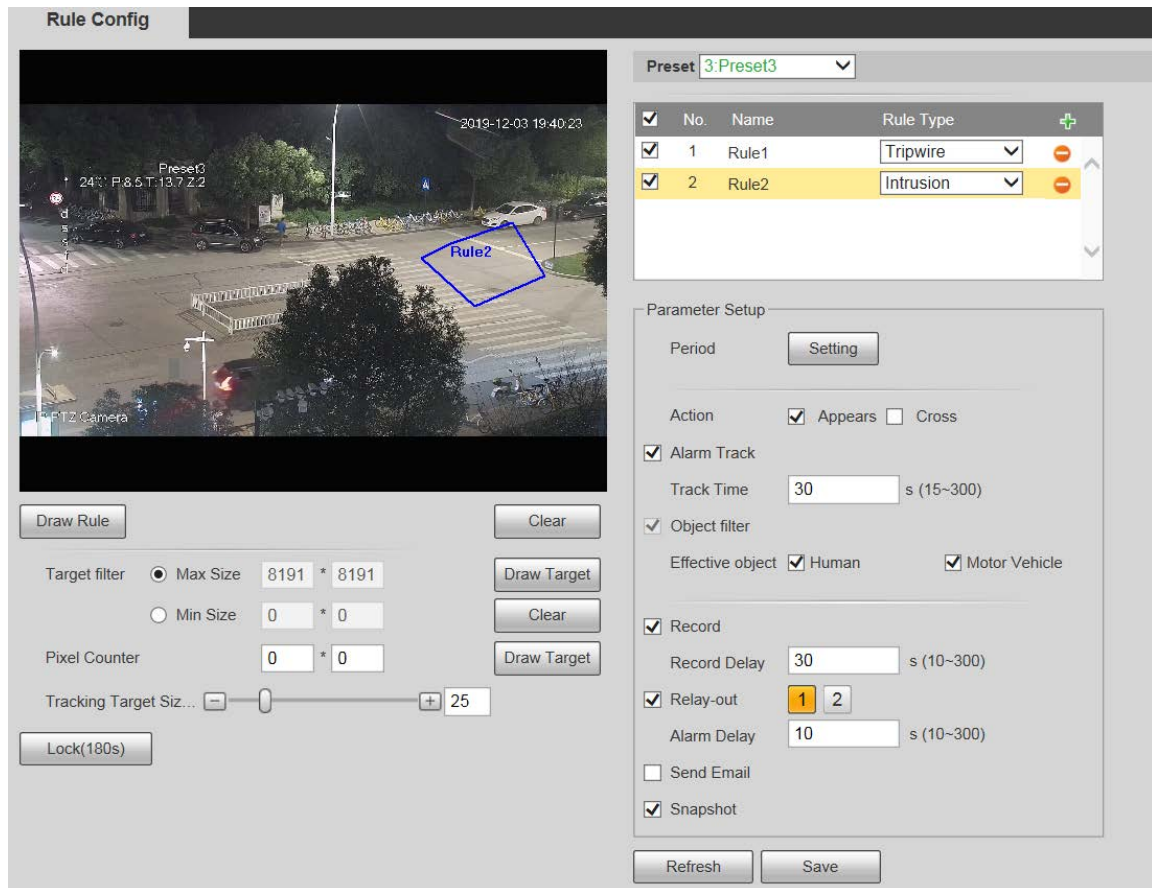
Similar to the warning line, to detect an entry/exit event, a certain movement space should be reserved at the periphery of the area line.

Applicable scenes: Scenes with sparse targets and no occlusion between targets, such as perimeter protection of unattended areas.

Procedure

Step 1 Select **Intrusion** from the **Rule Type** list.

Figure 5-95 Intrusion settings



Step 2 Click **Draw Rule**, and you can draw rules on the monitoring screen.
For parameter description, see Table 5-28.



Click **Clear** to the right of **Draw Rule** to clear all drawn rules.

Step 3 Configure parameters as needed.

Table 5-30 Intrusion parameter description

Parameter	Description
Action	Configure intrusion action, and you can select Appear or Cross .
Direction	Select the crossing direction from Enters , Exits , and Enter & Exit .



For other parameters, see "5.5.5.1 Tripwire".

Step 4 Click **Save**.

5.5.5.3 Abandoned Object

An alarm will be triggered when the selected target in the monitoring scene stays in the screen for more than the defined time.

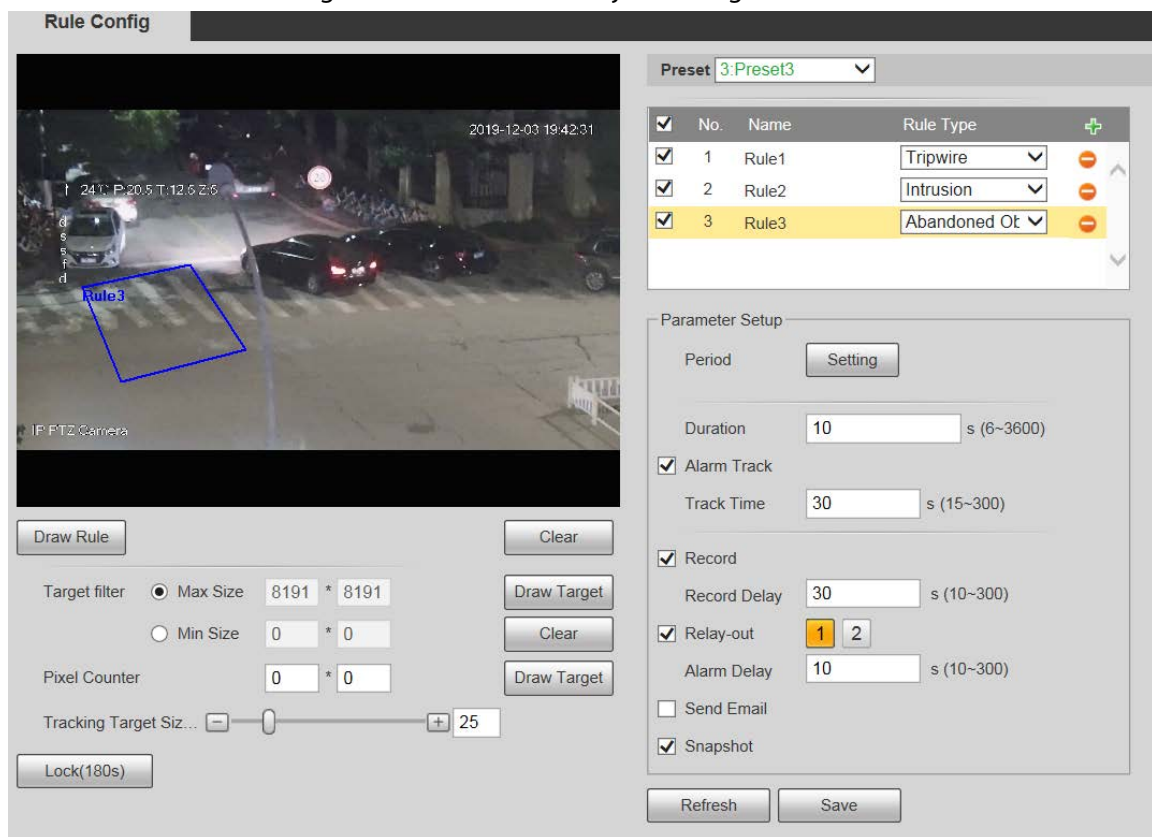
Pedestrians or vehicles that stay for too long would be regarded as abandoned objects. To filter out such alarms, you can use **Target filter**. In addition, the duration can be properly extended to avoid false alarm due to a short stay of people.

Applicable scenes: Scenes with sparse targets, no obvious and frequent light changes. For scenes with intensive targets or too many obstacles, missed alarms would increase; for scenes in which too many people stay, false alarms would increase. Select detection areas with simple texture, because this function is not applicable to scenes with complex texture.

Procedure

Step 1 Select **Abandoned Object** from the **Rule Type** list.

Figure 5-96 Abandoned object settings



Step 2 Click **Draw Rule**, and you can draw rules on the monitoring screen.
For parameter description, see Table 5-28.



Click **Clear** to the right of **Draw Rule**, and you can clear all drawn rules.

Step 3 Configure parameters as needed.

Table 5-31 Abandoned object parameter description

Parameter	Description
Duration	For abandoned object, the duration is the shortest time to trigger an alarm after an object is abandoned.



For other parameters, see "5.5.5.1 Tripwire".

Step 4 Click **Save**.

5.5.5.4 Missing Object

An alarm will be triggered when the selected target in the scene is taken away for the time longer than the set duration.

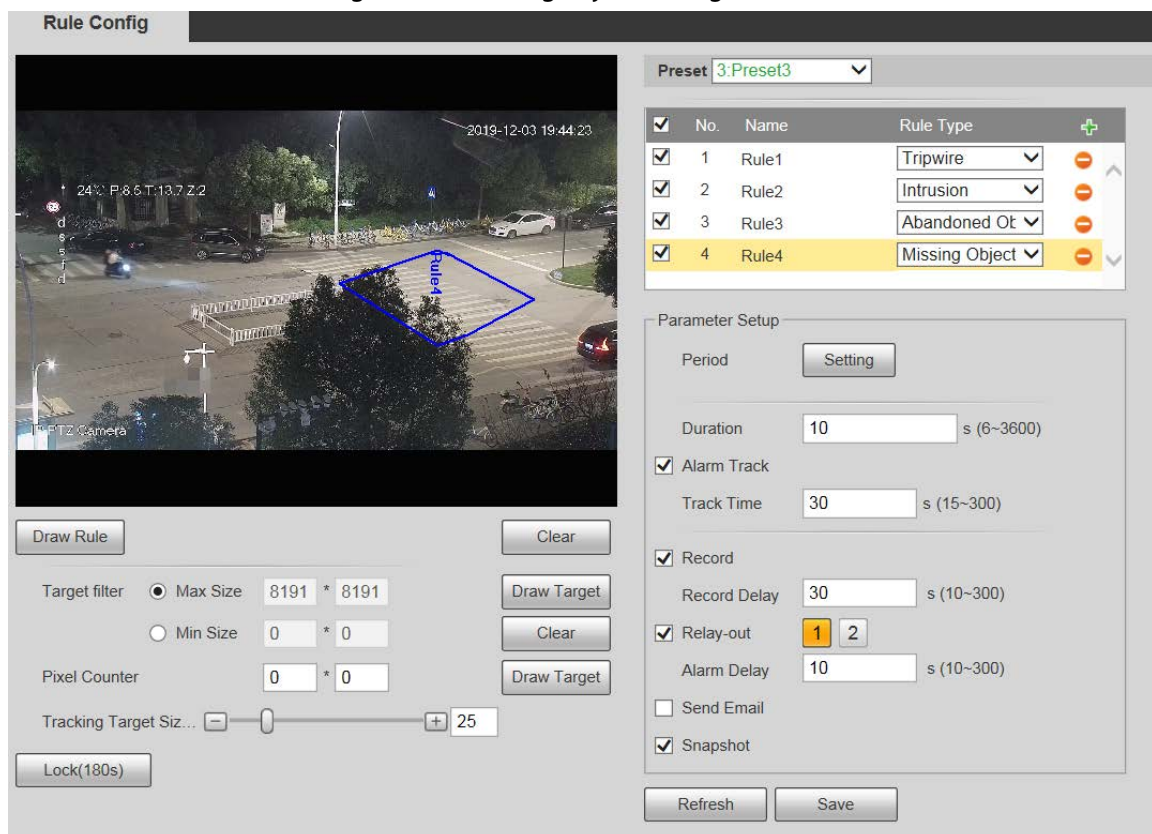
The system analyzes static areas from the foreground, and determines whether it is missing object or abandoned object from the similarity of its foreground and background. When the time exceeds the set period, an alarm is triggered.

Applicable scenes: Scenes with sparse targets, no obvious and frequent light changes. For scenes with intensive targets or too many obstacles, the missed alarm would increase; for scenes in which too many people stay, the false alarm would increase. Keep the detection area texture as possible simple as possible, because this function is not applicable to scenes with complex texture.

Procedure

Step 1 Select **Missing Object** from the **Rule Type** list.

Figure 5-97 Missing object setting



Step 2 Click **Draw Rule**, and you can draw rules on the monitoring screen.
For parameter description, see Table 5-28.



Click **Clear** to the right of **Draw Rule** to clear all drawn rules.

Step 3 Configure parameters as needed.

Table 5-32 Missing object parameter description

Parameter	Description
Duration	Configure the shortest time from the object disappearing to the alarm being triggered.



For other parameters, see "5.5.5.1 Tripwire".

Step 4 Click **Save**.

5.5.6 Construction Monitoring

The Device can be used for construction monitoring which include helmet detection, workwear detection, lone working detection and absence detection.

Prerequisites

Select **Setting** > **Event** > **Smart Plan**, and then enable **Construction Monitoring**.

Procedure

Step 1 Select **Setting** > **Event** > **Construction Monitoring**.

Step 2 Select **Global** or a preset from the **Preset** list.

- If global plan is selected, detection area and rule are set by default, and the detection area cannot be changed.
- If a preset is selected, you need to set detection area and rule manually. The following section takes selecting Preset 1 as an example.

Figure 5-98 Global plan

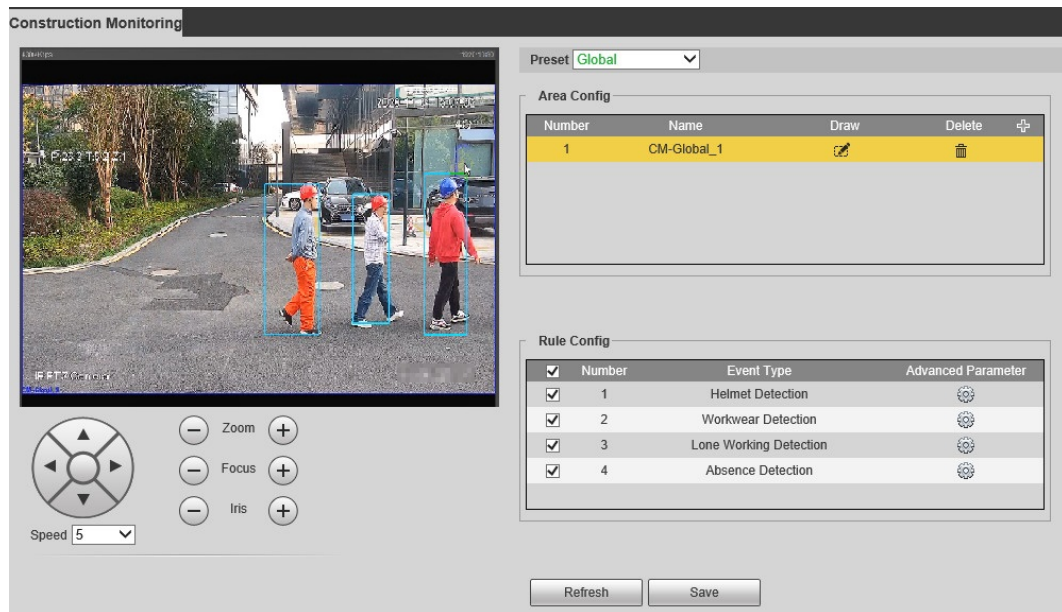
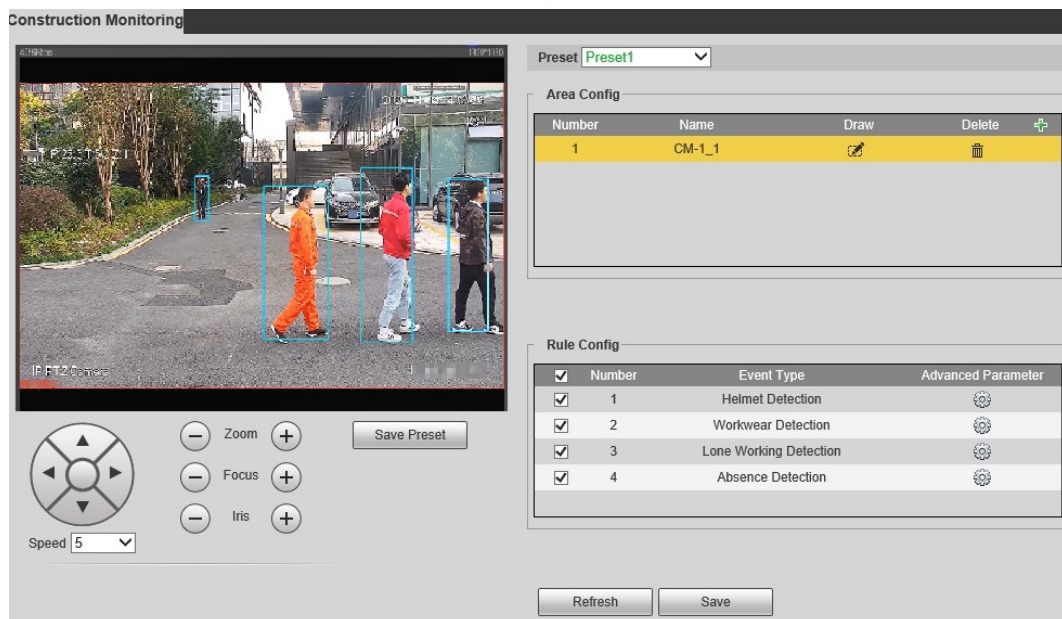


Figure 5-99 Plan by preset



Step 3 Click at the upper-right corner of the **Area Config** section.



Double click the rule name to modify it.

Step 4 Click to draw rule box on the video image, and then right-click to complete drawing.



- After drawing is complete, drag the corners of the drawn area to adjust the detection area.
- If you select preset plan, 8 detection areas can be drawn at most.

Step 5 Select the check box before the event type to enable the corresponding detection rule.

Table 5-33 Rule description

Rule	Description
Helmet Detection	When the Device detects person not wearing helmet or not wearing helmet in the specified color, alarm linkage actions will be performed.
Workwear Detection	When the Device detects person not wearing workwear in accordance with the rule, alarm linkage actions will be performed. The rule for workwear is long-sleeved tops and trousers in the same color. If short-sleeved shirts, shorts or different colors are detected, it means the rule is not followed.
Lone Working Detection	When the Device detects a single person working in the detection area, alarm linkage actions will be performed.
Absence Detection	When the Device detects nobody working in the detection area, alarm linkage actions will be performed.


Step 6 Click  next to the detection rule, configure parameters on the **Advanced Parameter** interface, and then click **Save**.

Figure 5-100 Helmet detection

Advanced Parameter

Rule Parameter

Allowed Color

White Yellow Red Blue

Duration s (1~3600)

Repeat Alarm Time s (10~3600)

Record

Record Delay s (10~300)

Relay-out

Alarm Delay s (10~300)

Send Email

Audio Linkage

Play Count (1~3)

File

Message Link

Snapshot

Period

Figure 5-101 Workwear detection

Advanced Parameter

Rule Parameter

Duration s (1~3600)

Repeat Alarm Time s (10~3600)

Record

Record Delay s (10~300)

Relay-out

Alarm Delay s (10~300)

Send Email

Audio Linkage

Play Count (1~3)

File

Message Link

Snapshot

Period

Figure 5-102 Lone working detection

Figure 5-103 Absence detection

Table 5-34 Parameter description

Parameter	Description
Allowed Color	When configuring helmet detection, you can set allowed colors. When the helmet detected is not in the selected colors, alarms will be triggered.

Parameter	Description
Duration	When events not following the rule are detected and the duration exceeds the defined value, alarms will be triggered. For example, when the duration of helmet detection is 5 seconds, if the Device detects a person not wearing helmet or the helmet color is not allowed for more than 5 seconds, an alarm will be triggered.
Repeat Alarm Time	After an alarm is triggered, when the event lasts for the time reaching repeated alarm time, an alarm will be triggered again.
Record	After you enable the function, when an alarm is triggered, the system will start recording automatically. Before using the function, you need to set the recording period of the alarm in Storage > Schedule , and select Auto for Record Mode on the Record Control interface.
Record Delay	When an alarm is over, the alarm recording will continue for an extended period of time.
Relay-out	Select the check box, and you can enable the alarm linkage output port, and link corresponding relay-out devices after an alarm is triggered.
Alarm Delay	When an alarm is over, the alarm will continue for an extended period of time.
Send Email	After you select the check box, when an alarm is triggered, the system sends email to the specified email address. You can configure the email address in "5.2.8 SNMP".
Audio Linkage	Select the check box to play alarm audio when alarms are triggered. You can set the play count and select the audio file. For how to set the audio file, see "5.1.3.2 Configuring Alarm Audio".
Message Link	Select the check box to receive message when alarms are triggered.
Snapshot	Select the check box, and the system will automatically take snapshots in case of alarms. You need to set snapshot period in Storage > Schedule .
Period	Set the alarm period to enable alarm events in the defined period. <ol style="list-style-type: none"> 1. Click Setup, and the Period interface is displayed. 2. Enter the time value or press and hold the left mouse button, and drag directly on the setting interface. There are six periods for each day. Select the check box next to the period for it to take effect. 3. Select the day of week (Sunday is selected by default; If All is selected, the setting is applied to the whole week. You can also select the check box next to the day to set it separately). 4. After completing the setting, click Save to go back to the rule configuration interface.

Step 7 Click **Save** on the **Construction Monitoring** interface.



If you want to see the alarm information on the **Alarm** tab, you need to subscribe the corresponding alarm type. For details, see "6 Alarm".

Result

Click the **AI Live** tab to view construction monitoring results. For details, see "3.2 AI Live Settings".

5.5.7 Face Recognition

The function can detect faces and compare them with those in the configured face database.



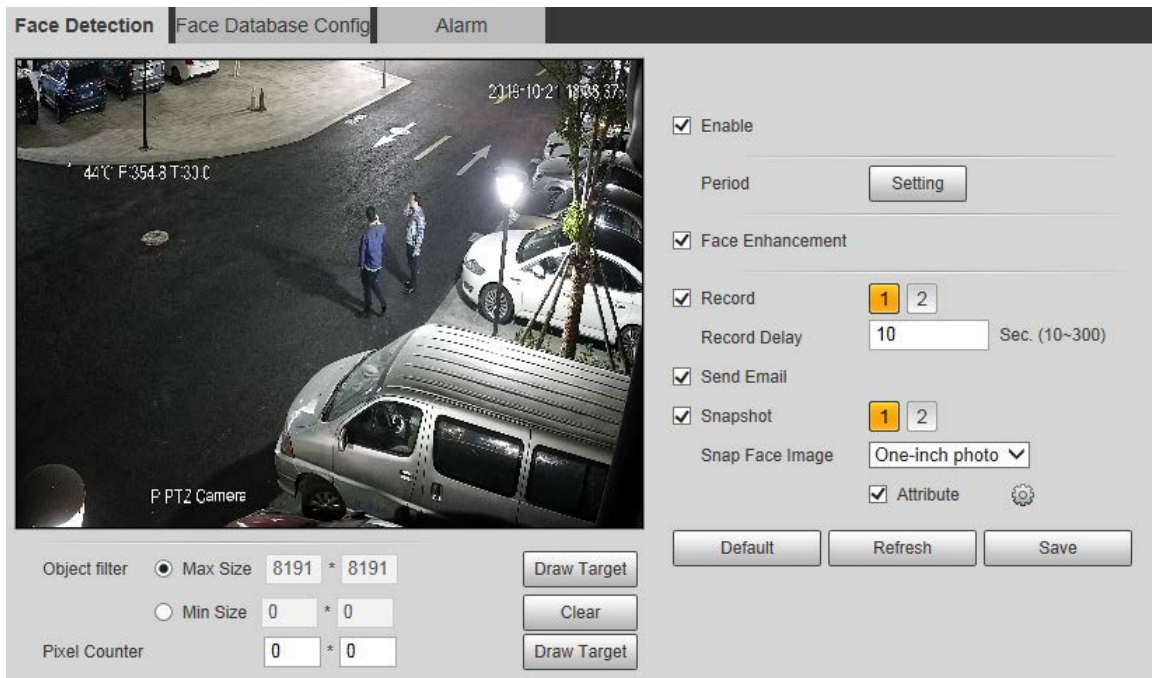
- Select **Setting > Event > Smart Plan**, and then enable face recognition.
- This function is available on select models.

5.5.7.1 Face Detection

When human face is detected in the monitoring screen, an alarm is triggered and the linked action is performed.

Step 1 Select **Setting > Event > Face Recognition > Face Detection**.

Figure 5-104 Face detection interface






Step 2 Select **Enable**, and you can enable the face detection function.

Step 3 Configure parameters as needed.

Table 5-35 Face detection parameter description

Parameter	Description
Period	Alarm event will be triggered only within the defined period. For details, see "5.5.1.1 Motion Detection".
Face Enhancement	Select Face Enhancement to preferably guarantee clear faces with low stream.

Parameter	Description
Record	Select Record , and the system records video when alarms are triggered.  To enable video recording, you need to make sure that: <ul style="list-style-type: none"> • The motion detection recording is enabled. For details, see "5.6.1.1 Record". • The auto recording is enabled. For details, see "5.6.4 Record Control".
Record Delay	The video recording will not stop until the record delay time you set has passed.
Send Email	Select Send Email , and when alarms are triggered, the system sends email to the specified mailbox. For the email settings, see "5.2.5 SMTP (Email)".
Snapshot	Select Snapshot , and the system takes snapshot when alarms are triggered.  <ul style="list-style-type: none"> • Enable the motion detection snapshot first. For details, see "5.6.1.1 Record". • For searching and setting snapshot storage path, see "5.1.2.5 Path".
Snap Face Image	Set the snapshot scope, including Face and One-inch photo .
Attribute	Select the Attribute check box, click  , and then you can set the human attributes during face detection.

Step 4 Click **Save**.

5.5.7.2 Face Database Config

After you successfully configure the face database, the detected faces can be compared with the information in the face database. Configuring a face database includes creating a face database, adding face pictures, and face modeling.

5.5.7.2.1 Adding Face Database

Create a face database, and then register face images, that is to add face pictures to the newly created face database.

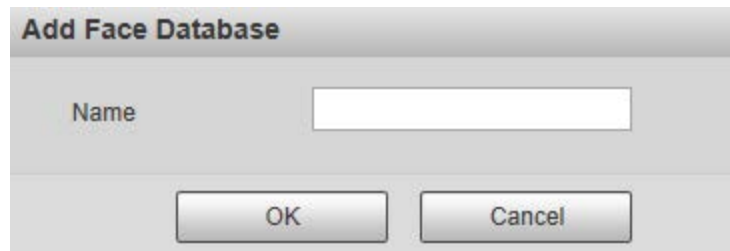
Step 1 Select **Setting > Event > Face Recognition > Face Database Config**.

Figure 5-105 Face database config



Step 2 Click **Add Face Database**.

Figure 5-106 Add face database



Step 3 Set face database name.

Step 4 Click **OK** to complete the addition.

Figure 5-107 Add face database completed



Step 5 Configure parameters as needed.

Table 5-36 Face database config parameter description

Parameter	Description
Deploy	Select Deploy and the face database takes effect.
Similarity Threshold	The comparison is successful only when the similarity between the detected face and the face feature in face database reaches the set similarity threshold. After this, the comparison result is displayed on the Live interface.
More Info	Click More Info to manage face database. You can set search conditions, register people, and modify people information.
Arm/Disarm	Alarm event will be triggered only within the defined time period. For details, see "5.5.1.1 Motion Detection".
Delete	Delete the selected face database.

5.5.7.2.2 Adding Face Pictures

You can add face pictures to the created face database. Manual addition and batch import are supported.

Manual Addition

Add a single face picture. Use this method when registering a small number of face pictures.

Step 1 Select **Setting > Event > Face Recognition > Face Database Config**.


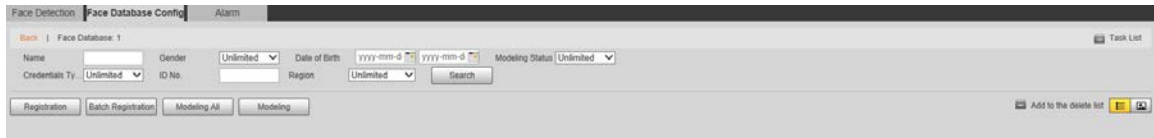
Step 2 Click  **More Info** for the face database to be configured.

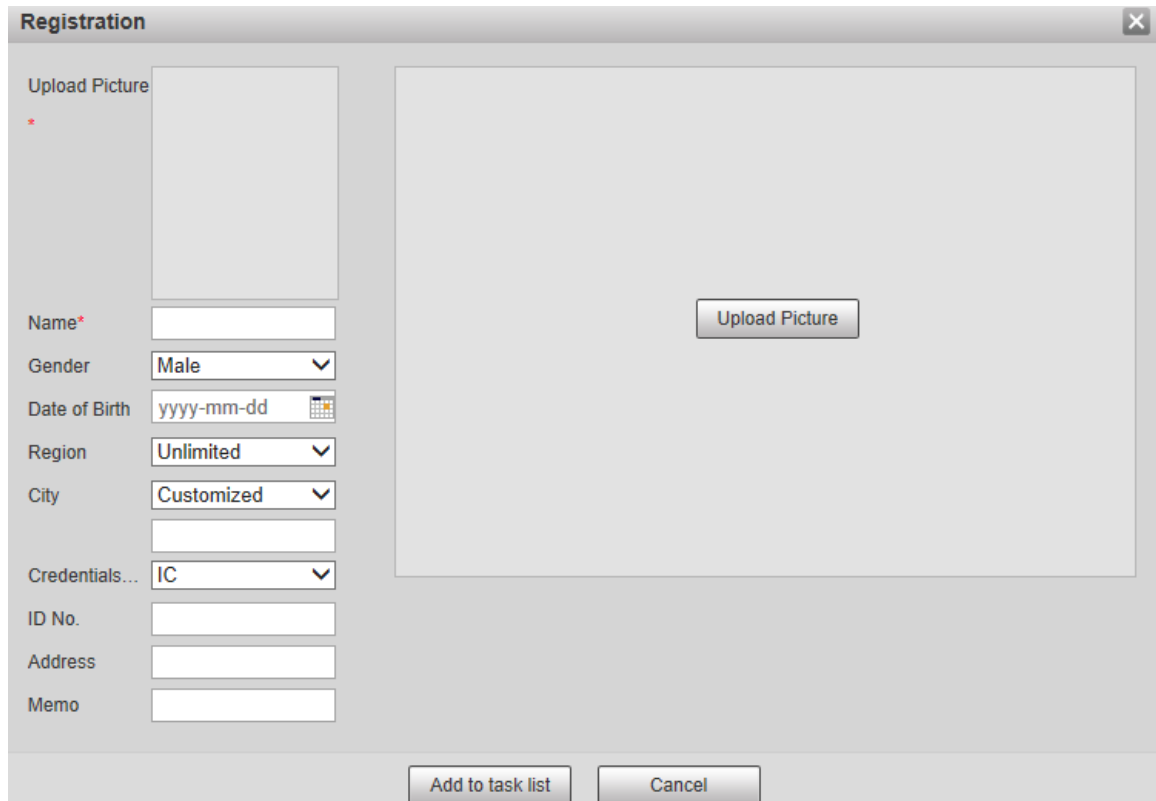
Figure 5-108 More info



Set filtering conditions as needed, and then click **Search**. The search result is displayed.

Step 3 Click **Registration**.

Figure 5-109 Registration interface



Step 4 Click **Upload Picture**, and then import the face pictures to be uploaded.



You can manually select a face area. After uploading the picture, select a face area and click **OK**. If there are multiple faces in a picture, select the target face and click **OK** to save the face picture.

Figure 5-110 Addition completed

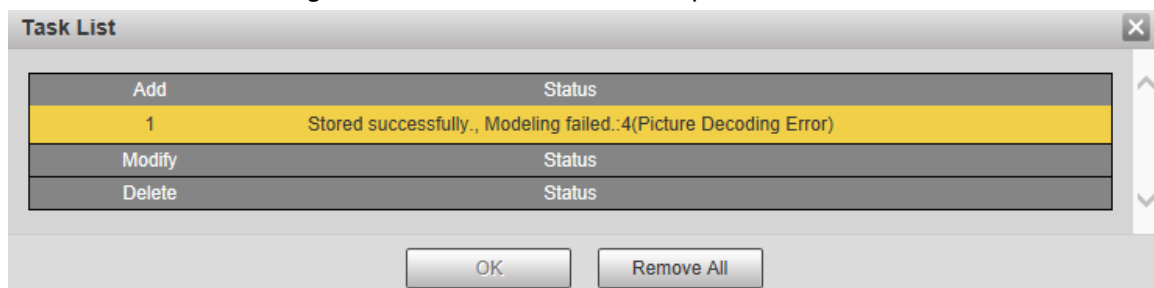


Step 5 Fill in face picture information as needed.

Step 6 Click **Add to task list**.

Step 7 Click  **Task List 1**.

Figure 5-111 Task list addition completed



Click **Remove All** to remove all the tasks.

Batch Registration

You can import multiple face pictures in batches. Use this method when registering a large number of face pictures.

Before importing pictures in batches, name the face pictures in the format of "Name#SGender#BDate of Birth#NRegion#TCredentials Type#MID No. jpg" (for example,

"John#S1#B1990-01-01#NCN#T1#M330501199001016222").



Name is required and the rest are optional.

Table 5-37 Naming rules for batch import

Naming Rules	Description
Name	Enter the corresponding name.
Gender	Enter a number. 1: Male; 2: Female.
Date of Birth	Enter numbers in the format of yyyy-mm-dd. For example, 2017-11-23.
Region	Enter the region name.
Credentials Type	Enter a number. 1: ID card; 2: passport.
ID No.	Enter ID No.

Step 1 Select **Setting > Event > Face Recognition > Face Database Config**.

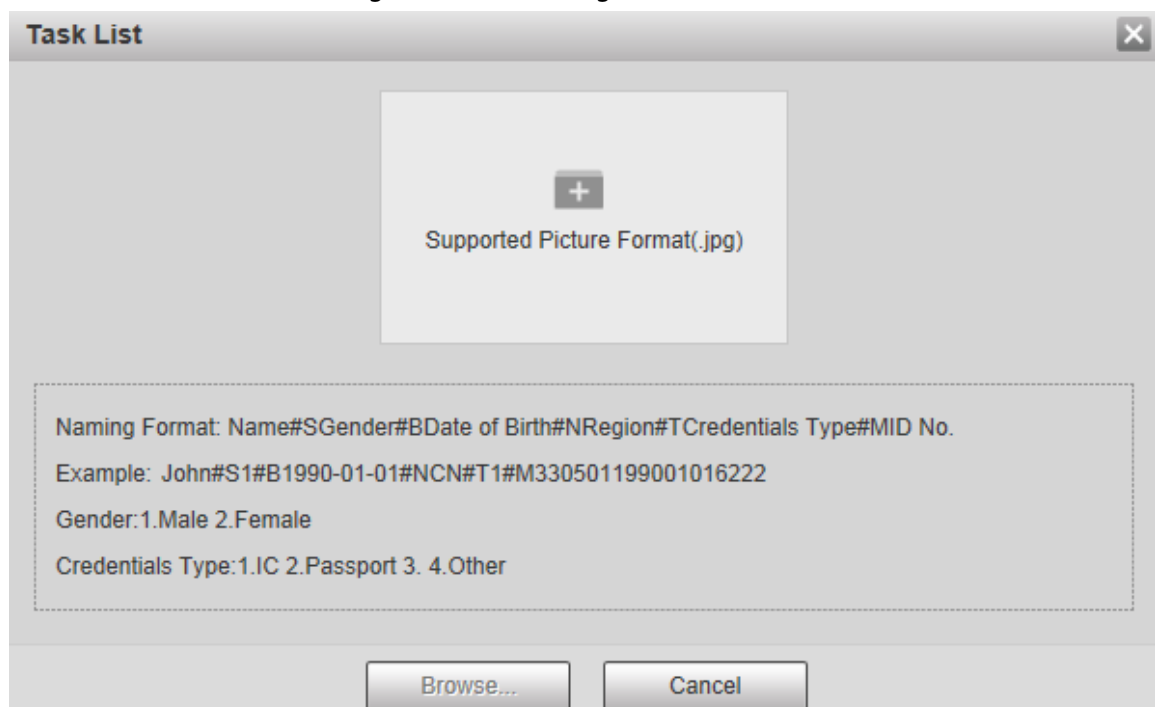
The **Face Database Config** interface is displayed.

Step 2 Click **More Info** for the face database to be configured.

The **Face Database** interface is displayed.

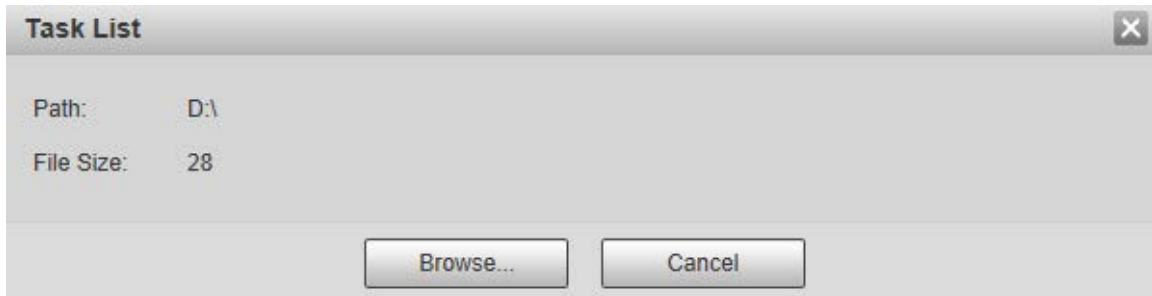
Step 3 Click **Batch Registration**.

Figure 5-112 Batch registration



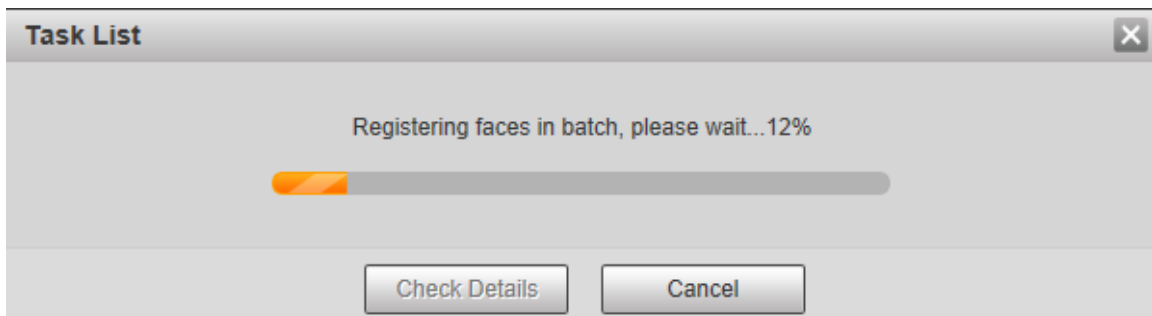
Step 4 Click to select the file path.

Figure 5-113 Batch registration



Step 5 Click **Browse**.

Figure 5-114 Registering



Step 6 After the registration is completed, click **Next** to view the registration result.

5.5.7.2.3 Managing Face Pictures

You can add face pictures to face database; manage and maintain face pictures to ensure correct information.

Modifying Face Information



On the **Face Database Config** interface, move the mouse pointer to the face picture or person information line. Click  or , and the **Registration** interface is displayed. After modifying the face picture information as needed, click **Add to task list**.

Figure 5-115 Registration interface

Deleting Face Pictures

Enter face database, and then delete the created face picture.

- Single deletion: Move the mouse pointer to the face picture or people information line, and then click or to delete the face picture.
- Batch deletion: Move the mouse pointer to the face picture or people information line, and then click at the upper right corner of the face pictures, or click on person information line. After selecting multiple items, click **Add to the delete list**, click **Task List 1**, and then click **OK** to delete the selected face pictures.
- Delete all: When viewing face pictures in a list, click on people information line (or select **All** when viewing face pictures in pictures), click **Add to the delete list**, click **Task List 1**, and then click **OK** to delete all face pictures.

5.5.7.2.4 Face Modeling

You can extract and import the relevant information of face pictures into the database through face modeling, and create a face feature mode for smart detection such as face comparison.

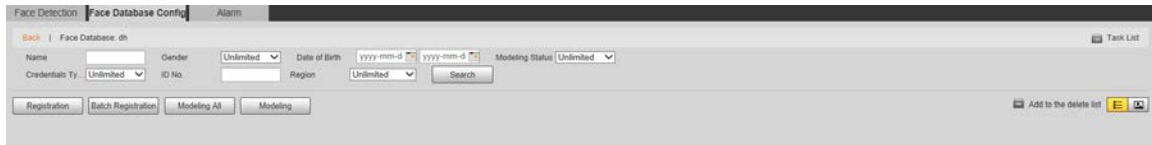


- The more face pictures you choose, the longer the modeling time is. Wait patiently.
- During the modeling process, some smart detection functions (such as face comparison) are temporarily unavailable and can be resumed after the modeling is completed.

Step 1 Select **Setting > Event > Face Recognition > Face Database Config**.

Step 2 Click **More Info** for the face database to be configured.

Figure 5-116 Face database interface



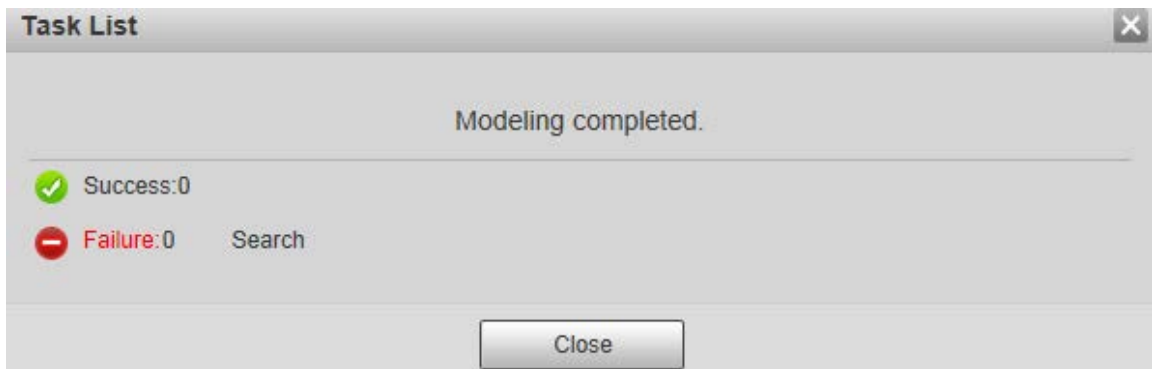
Step 3 Select the face pictures for modeling as needed.



Click to view the face picture in a list. Click to view the face image as a thumbnail.

- **Modeling All**
Click **Modeling All**, and all face pictures in the face database will be modeled.
- **Selective Modeling**
If there are many face pictures in the face database, set filtering conditions and click **Search** to select face pictures for modeling.

Figure 5-117 Modeling completed

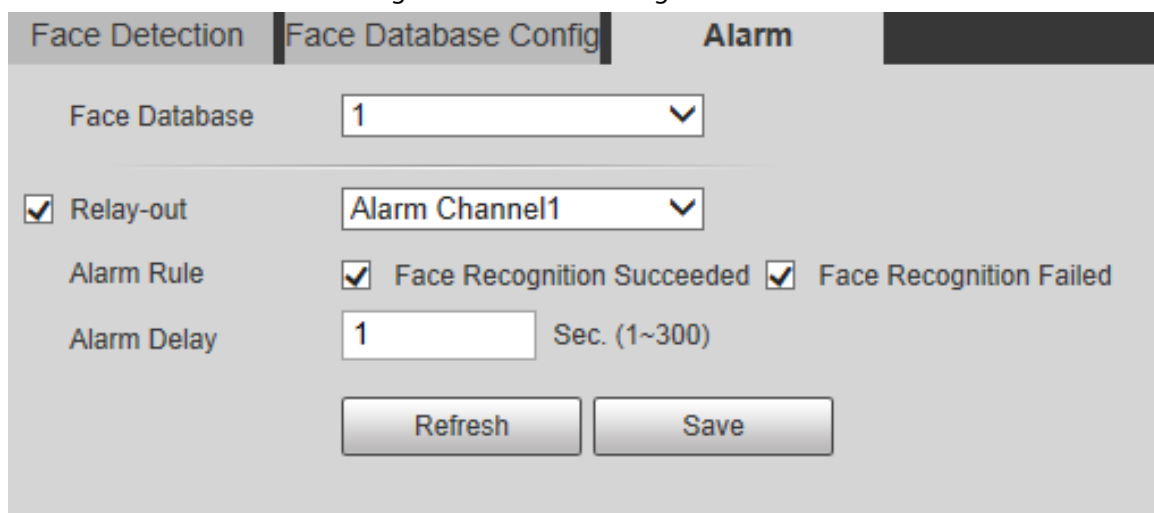


5.5.7.3 Alarm Linkage

Set the alarm linkage mode for face comparison.

Step 1 Select **Setting > Event > Face Recognition > Alarm**.

Figure 5-118 Alarm linkage



Step 2 Configure parameters as needed.

Table 5-38 Alarm linkage parameter description

Parameter	Description
Face Database	Select the face database to be configured with alarm linkage.
Alarm Rule	Select the alarm rule as needed.
Relay-out	Select the Relay-out check box, and when an alarm is triggered, the system interacts with the linked alarm devices.
Alarm Delay	The alarm will continue for an extended period of time. The value range is 1–300 s.

Step 3 Click **Save**.

5.5.8 People Counting

You can use this function to count the number of people in the area and generate reports.



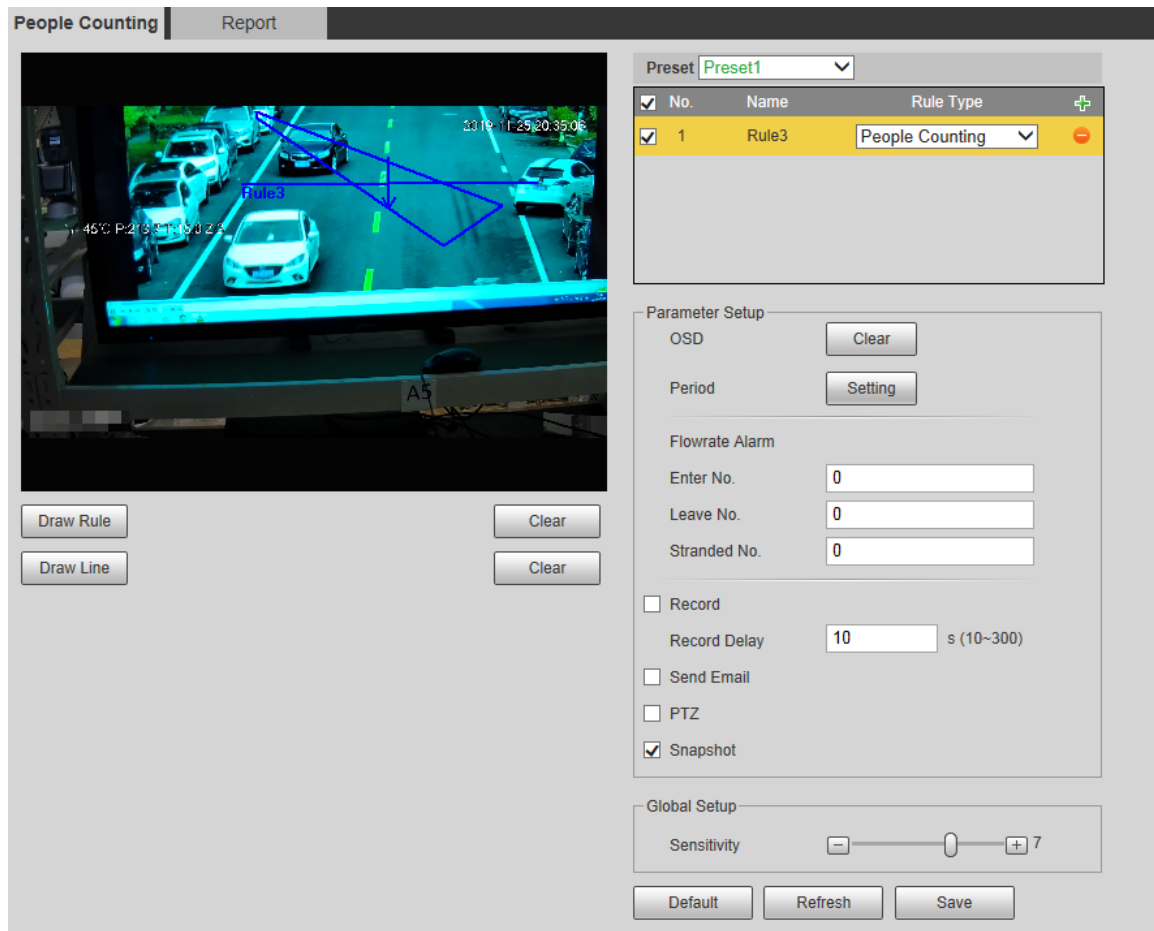
- Before using this function, you need to enable **People Counting** in **Smart Plan**.
- The people counting data will be overwritten if the disk is full. Back up the data in time as needed.
- This function is available on select models.

5.5.8.1 People Counting Settings

With the function, the system can count the number of people appearing in the monitoring screen within a certain period.

Step 1 Select **Setting** > **Event** > **People Counting** > **People Counting**.

Figure 5-119 People counting settings



Step 2 Select the presets to be configured.

Step 3 Click **Draw Rule**, and you can draw rules on the monitoring screen. For parameter description, see Table 5-28.



Click **Clear** to the right of **Draw Rule**, and you can clear all drawn rules.

Step 4 Configure parameters as needed.

Table 5-39 People counting parameter description

Parameter	Description
OSD	Display the number of people displayed in the area in real time. Click Clear , and the current number will be zero.
Enter No.	Set the Enter No. , and when the number of people entering reaches the set value, an alarm will be triggered.
Leave No.	Set the Leave No. , and when the number of people leaving reaches the set value, an alarm will be triggered.
Stranded No.	Set the Stranded No. , and when the number of people staying reaches the set value, an alarm will be triggered.



For other parameters, see "5.5.5.1 Tripwire".

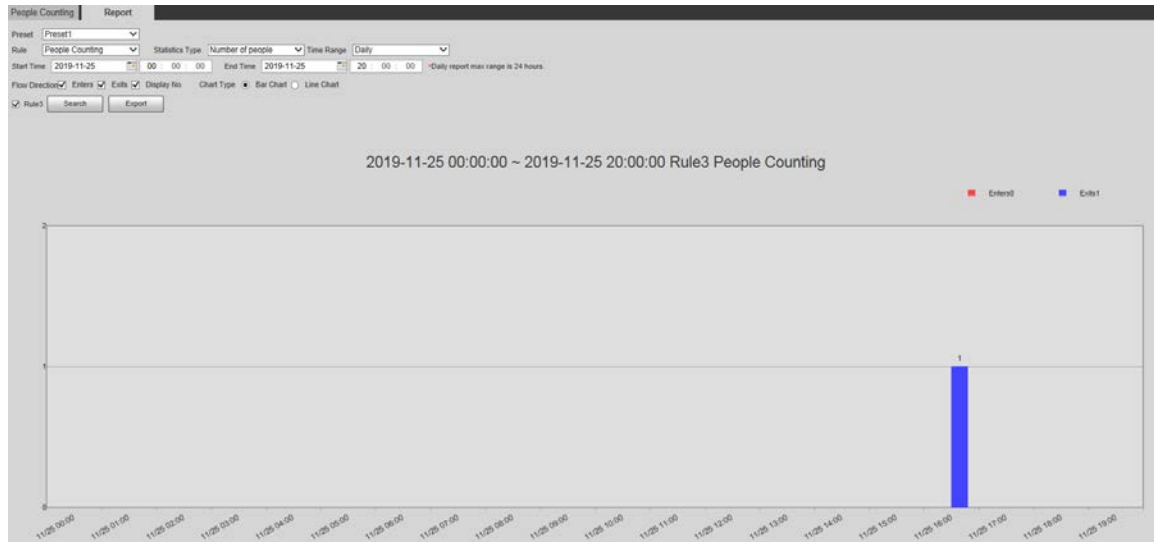
Step 5 Click **Save**.

5.5.8.2 Report

You can view the statistics results of people in the scene during the selected period.

Step 1 Select **Setting > Event > People Counting > Report**.

Figure 5-120 People counting report



Step 2 Select a preset.

Step 3 Select the **Rule**, **Statistics Type**, and **Time Range**.

Step 4 Select the start time and end time for searching reports.

Step 5 Select **Flow Direction** and **Chart Type**.

Step 6 Click **Search** to generate reports, and click **Export** to export the report to local storage.

5.5.9 Heat Map



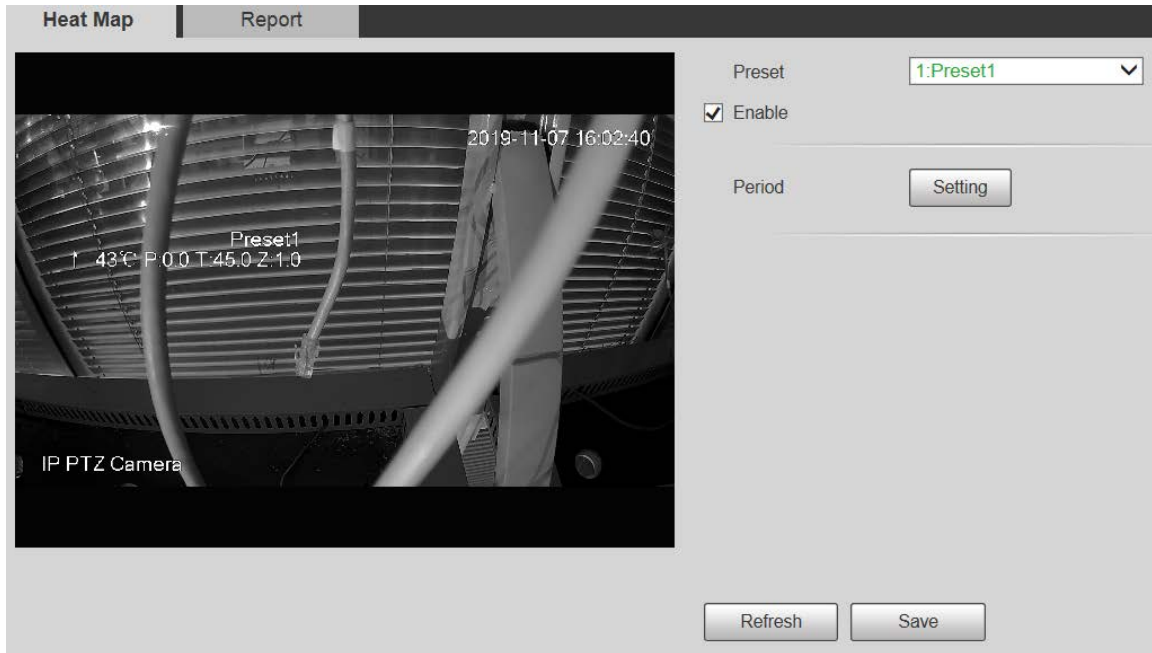
- Before enabling **Heat Map**, you need to set presets in **PTZ** section, and select the function in the **Smart Plan**.
- The data will be overwritten if the disk is full. Back up the data in time as needed.
- This function is available on select models.

5.5.9.1 Heat Map Settings

The function can be used to detect the activity level of moving objects in the scene during a certain period.

Step 1 Select **Setting > Event > Heat Map > Heat Map**.

Figure 5-121 Heat map



- Step 2 Select the presets to be configured.
- Step 3 Select the **Enable** check box, and then the heat map function is enabled.
- Step 4 Click **Setting** to set the arming period. For details, see "5.5.1.1 Motion Detection".
- Step 5 Click **Save**.

5.5.9.2 Report

You can view the heat map report for the scene in the selected period.

- Step 1 Select **Setting > Event > Heat Map > Report**.
The **Report** interface is displayed.
- Step 2 Set the start time and end time to search for the heat map report.
- Step 3 Select a preset.
- Step 4 Click **Search**, and the search results will be displayed on the interface.

Figure 5-122 Report



5.5.10 Video Metadata

With the function, the system can count the number of motor vehicles, non-motor vehicles and people in the monitoring screen, identify the features of the vehicles and people in the scene, and take snapshots.



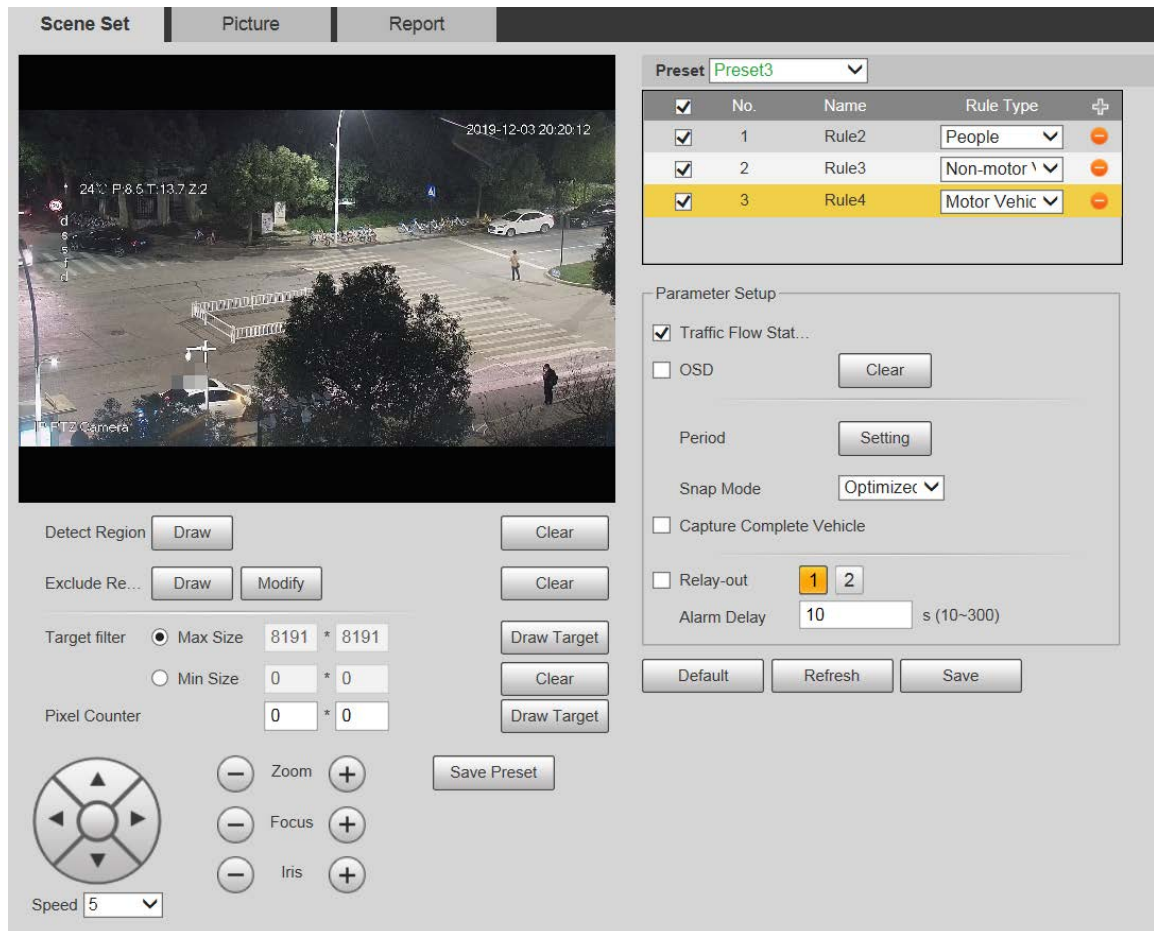
- Before using video metadata, you need to enable the function in the **Smart Plan**.
- This function is available on select models.

5.5.10.1 Scene Setting

Set the parameters of snapshot, analysis and alarm in the scene.

Step 1 Select **Setting** > **Event** > **Video Metadata**.

Figure 5-123 Scene setting



- Step 2** Click the **Preset** list to select the preset to configure video metadata.
- Step 3** Click to add a rule type.
- Step 4** Modify the parameters as needed.
- Double-click the name to modify the rule name.
 - Select the rule type from **People**, **Non-motor Vehicle** and **Motor Vehicle**.
 - Click the corresponding to delete detection items.
- Step 5** Configure parameters as needed.

Table 5-40 Scene setting parameter description

Parameter	Description
People Flow Statistics	After selection, traffic flow statistics will be displayed on the screen.
Non-motor Vehicle Flow Statistics	
Traffic Flow Statistics	
OSD	Select the check box to enable the OSD overlay. The statistics will be displayed on the Live interface in the form of OSD information.
Clear	Click it to clear the statistics of motor vehicles, non-motor vehicles and people.



For other parameters, see "5.5.5.1 Tripwire".

Step 6 Click **Save**.

5.5.10.2 Picture Overlay

Set the overlay information on the snapshot.

Step 1 Select **Setting > Event > Video Metadata > Overlay**.

The **Picture** interface is displayed.

Step 2 Select **Picture Overlay Type** from **People, Non-motor Vehicle** and **Motor Vehicle**.

Figure 5-124 Picture overlay–motor vehicle

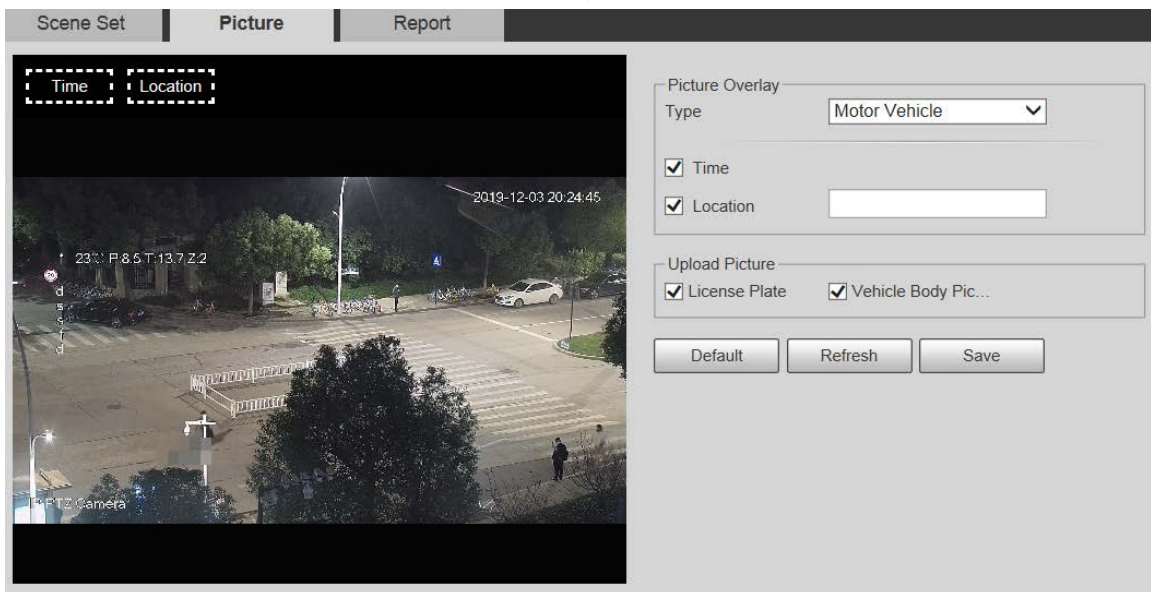


Figure 5-125 Picture overlay–non-motor vehicle

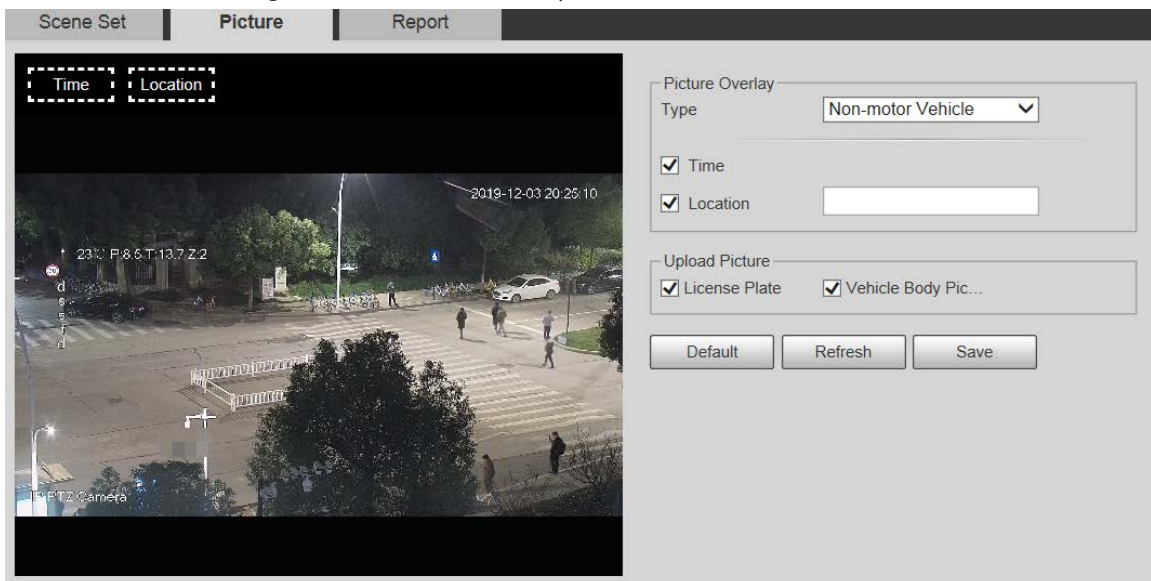
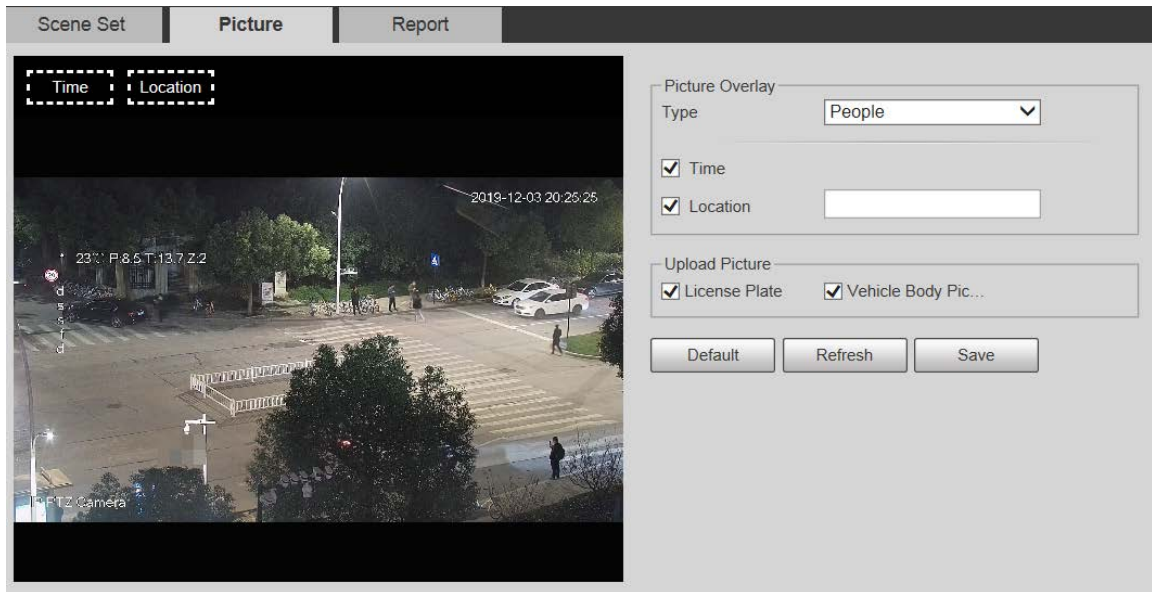


Figure 5-126 Picture overlay–people



Step 3 Select overlay information as needed.



If you select **Location**, you need to manually enter the location of the Device.

Step 4 Click **Save**.

5.5.10.3 Report

You can view the number of vehicles, non-vehicles and people in the scene during the selected period.

Step 1 Select **Setting > Event > Video Metadata > Report**.

The **Report** interface is displayed.

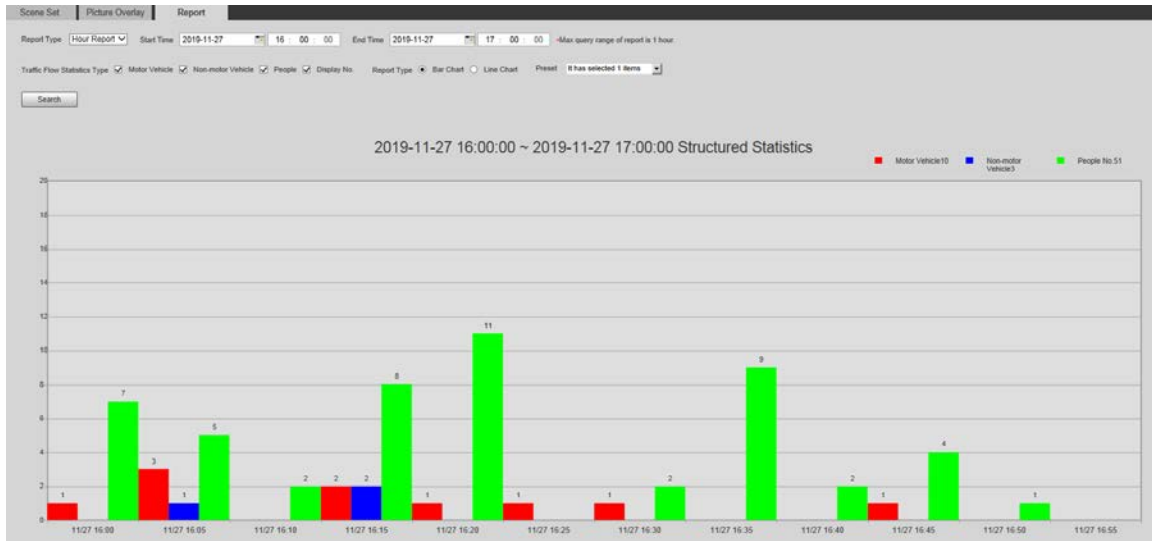
Step 2 Select the **Report Type**.

Step 3 Select the start time and end time for searching reports.

Step 4 Select **Traffic Flow Statistics Type**.

Step 5 Click **Search** to generate reports.

Figure 5-127 Video metadata report



5.5.11 Alarm

Step 1 Select **Setting** > **Event** > **Alarm**.

Figure 5-128 Alarm

Alarm

Enable

Relay-in: Alarm1 ▼

Period: Setting

Anti-Dither: 0 s (0~100) Sensor Type: NO ▼

Record

Record Delay: 10 s (10~300)

Relay-out: 1 2

Alarm Delay: 10 s (10~300)

Send Email

PTZ

Snapshot

Default
Refresh
Save

Step 2 Configure parameters as needed.

Table 5-41 Alarm setting parameter description

Parameter	Description
Enable	Select the Enable check box, and then the alarm linkage is enabled.
Relay-in	Select alarm input, and 7 alarm inputs are available.
Sensor Type	There are two types: NO (normally open) and NC (normally closed). Switch from NO to NC , and alarm event will be enabled. Switch from NC to NO , and alarm event will be disabled.



For other parameters, see "5.5.1.1 Motion Detection".

Step 3 Click **Save**.

5.5.12 Abnormality

Abnormality includes 7 alarm events: **No SD Card**, **Capacity Warning**, **SD Card Error**, **Disconnection**, **IP Conflict**, **Illegal Access**, and **Security Exception**.

5.5.12.1 SD Card

In case of an SD card exception, an alarm will be triggered.

Step 1 Select **Setting > Event > Abnormality > SD Card**.

Figure 5-129 No SD card

The screenshot shows the 'SD Card' configuration page with the 'No SD Card' event type selected. The 'Enable' checkbox is unchecked, 'Relay-out' is checked, and the 'Alarm Delay' is set to 10 seconds. The 'Send Email' checkbox is unchecked. At the bottom, there are 'Default', 'Refresh', and 'Save' buttons.

Figure 5-130 SD card error

The screenshot shows the 'SD Card' configuration page with the 'SD Card Error' event type selected. The 'Enable' checkbox is unchecked, 'Relay-out' is checked, and the 'Alarm Delay' is set to 10 seconds. The 'Send Email' checkbox is unchecked. At the bottom, there are 'Default', 'Refresh', and 'Save' buttons.

Figure 5-131 Capacity warning

The screenshot shows the 'SD Card' configuration page with the 'Capacity Warning' event type selected. The 'Enable' checkbox is unchecked, 'Capacity Limit' is set to 10%, 'Relay-out' is checked, and the 'Alarm Delay' is set to 10 seconds. The 'Send Email' checkbox is unchecked. At the bottom, there are 'Default', 'Refresh', and 'Save' buttons.

Step 2 Configure parameters as needed.

Table 5-42 SD card exception parameter description

Parameter	Description
Enable	Select the check box to enable this function.
Capacity Limit	Configure the free space percentage, and if the free space in the SD card is less than the defined percentage, an alarm is triggered.



For other parameters, see "5.4.1.1 Motion Detection."

Step 3 Click **Save**.

5.5.12.2 Network Exception

In case of a network exception, an alarm will be triggered.

Step 1 Select **Setting > Event > Abnormality > Network**.

Figure 5-132 Disconnection

SD Card	Network	Illegal Access	Security Exception
Event Type: Disconnection			
<input checked="" type="checkbox"/> Enable			
<input type="checkbox"/> Record			
Record Delay: 10 s (10~300)			
<input type="checkbox"/> Relay-out: 1 2			
Alarm Delay: 10 s (10~300)			
<input type="button" value="Default"/> <input type="button" value="Refresh"/> <input type="button" value="Save"/>			

Figure 5-133 IP conflict

SD Card	Network	Illegal Access	Security Exception
Event Type: IP Conflict			
<input checked="" type="checkbox"/> Enable			
<input type="checkbox"/> Record			
Record Delay: 10 s (10~300)			
<input type="checkbox"/> Relay-out: 1 2			
Alarm Delay: 10 s (10~300)			
<input type="button" value="Default"/> <input type="button" value="Refresh"/> <input type="button" value="Save"/>			

Step 2 Configure parameters as needed.

Table 5-43 Network exception parameter description

Parameter	Description
Enable	Select the check box to enable this function.



For other parameters, see "5.5.1.1 Motion Detection".

Step 3 Click **Save**.

5.5.12.3 Illegal Access

Illegal access alarm is triggered when the login password has been wrongly entered for more than the times you set.

Step 1 Select **Setting > Event > Abnormality > Illegal Access**.

Figure 5-134 Illegal access

Step 2 Configure parameters as needed.

Table 5-44 Illegal access parameter description

Parameter	Description
Enable	Select the check box to set the illegal access alarm.
Login Error	After entering a wrong password for the set times, the alarm for illegal access will be triggered, and the account will be locked.



For other parameters, see "5.5.1.1 Motion Detection".

Step 3 Click **Save**.

5.5.12.4 Security Exception

When an event affecting the Device safety occurs, an alarm for safety exception will be triggered.

Step 1 Select **Setting > Event > Abnormality > Security Exception**.

Figure 5-135 Security exception

- Step 2** Configure each parameter as needed.
For details, refer to "5.5.1.1 Motion Detection".
- Step 3** Click **Save**.

5.5.12.5 Battery Exception

When overtemperature of the battery is detected, alarm linkage actions are performed.

- Step 1** Select **Setting > Event > Abnormality > Battery Exception**.

Figure 5-136 Battery exception

- Step 2** Select the **Enable** check box to enable battery exception detection.
- Step 3** Set alarm linkage actions.
- Step 4** Click **Save**.

5.6 Storage

5.6.1 Schedule

Before setting the schedule, make sure that the **Record Mode** is **Auto** in **Record Control**.

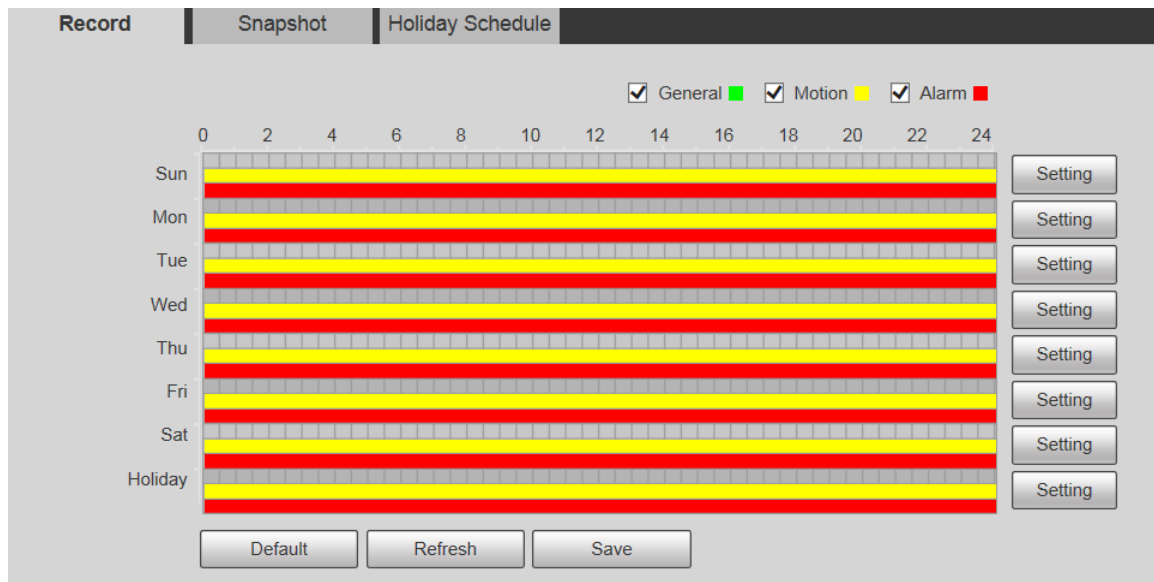


If the **Record Mode** is **Off**, the Device will not record or take snapshots according to the schedule.

5.6.1.1 Record

Step 1 Select **Setting** > **Storage** > **Schedule** > **Record**.

Figure 5-137 Record



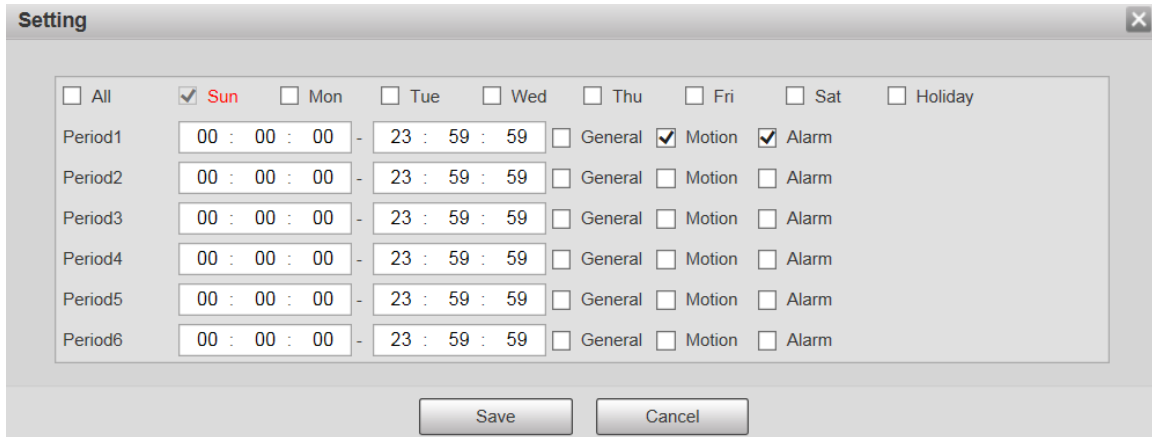
Step 2 Select the day for recording from Monday to Sunday. Click **Setting** on the right, and the **Setting** interface is displayed.

- Set the recording period as needed. You can set up to six periods for one day.
- You can select 3 types of recording: **General**, **Motion** and **Alarm**.



To set the time period, you can also press and hold the left mouse button and drag directly on the **Record** interface.

Figure 5-138 Record schedule setting



Step 3 Click **Save** to return to the **Record** interface.

At this time, the colored chart visually displays the defined period.




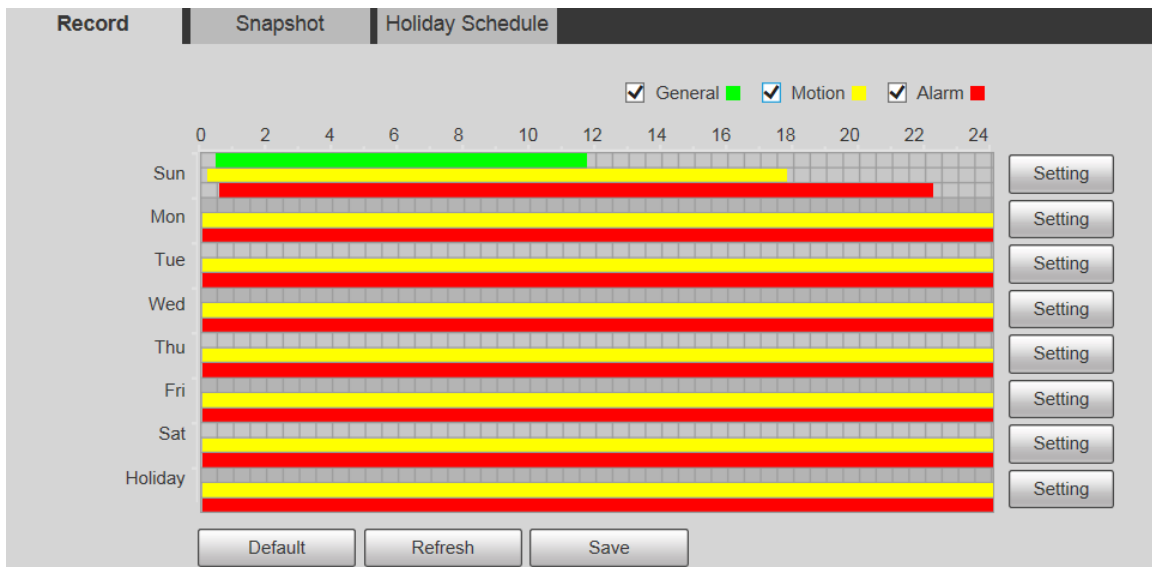
-  : Represents general recording.
-  : Represents motion detection recording.
-  : Represents alarm recording.

Figure 5-139 Recording schedule setting completed

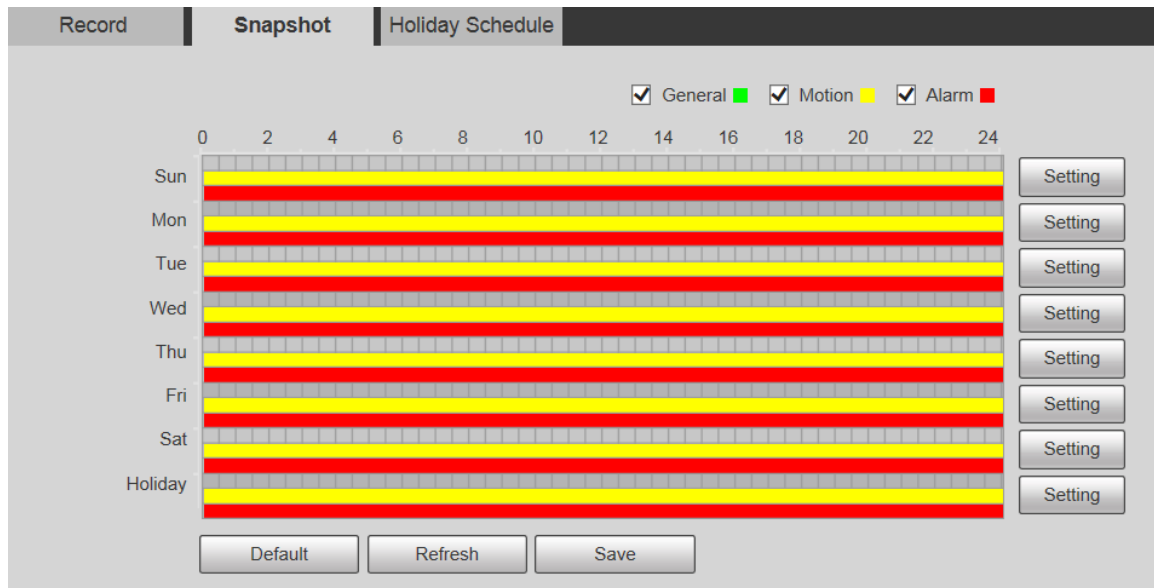


Step 4 On the **Record** interface, click **Save**, and the **Save Succeeded!** prompt will be displayed, which means the recording schedule has been set.

5.6.1.2 Snapshot

Step 1 Select **Setting > Storage > Schedule > Snapshot**.

Figure 5-140 Snapshot



Step 2 Set snapshot schedule.

For details, refer to [Step2](#) and [Step3](#) in "5.6.1.1 Record".

Step 3 Click **Save**, and the **Save Succeeded!** prompt will be displayed, which means the snapshot schedule has been set.

5.6.1.3 Holiday Schedule

You can set specific dates as holidays.

Step 1 Select **Setting > Storage > Schedule > Holiday Schedule**.

Figure 5-141 Holiday schedule

Record Snapshot **Holiday Schedule**

Record Snapshot

Calendar Dec ▾

Sun	Mon	Tue	Wen	Thu	Fri	Sat
1	2	3	4	5	6	7
8	9	10	11	12	13	14
15	16	17	18	19	20	21
22	23	24	25	26	27	28
29	30	31				

Refresh Save

Step 2 Select a date.

The selected date will be a holiday and displayed in yellow.

Step 3 Select **Record** or **Snapshot**, and then click **Save**.

The **Save Succeeded!** prompt will be displayed.

Step 4 On the **Record** or **Snapshot** interface, click **Setting** to the right of **Holiday**.



The setting method is the same as that of Monday to Sunday.

Step 5 Set the period of one day for the **Holiday**, and the recording or snapshot will be taken according to the holiday time period.

5.6.2 Snapshot by Location

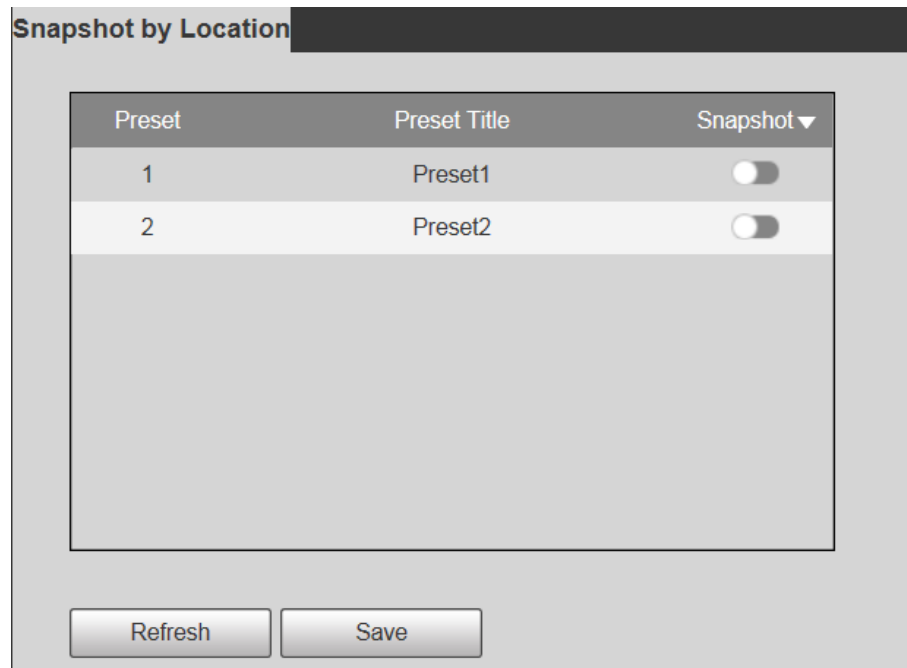
The system can take snapshots when the Device rotates to certain presets.



You need to set presets in advance.

Step 1 Select **Setting** > **Storage** > **Snapshot by Location**.

Figure 5-142 Snapshot by location



Step 2 Select presets.

- Enable snapshot by location.
 - ◇ Click to enable the function for the corresponding preset.
 - ◇ Click **Snapshot** ▼, and then select **All Enabled** to enable the function for all presets.
- Disable snapshot by location.
 - ◇ Click to disable the function for the corresponding preset.
 - ◇ Click **Snapshot** ▼, and then select **All Disabled** to disable the function for all presets.

Step 3 Click **Save**.

5.6.3 Destination

5.6.3.1 Path

Configure the storage path of recordings and snapshots of the Device, and select local SD card, FTP and NAS for storage. Store recordings and snapshots according to the event type, respectively corresponding to **General**, **Motion** and **Alarm** in the schedule, and then select the corresponding type of recordings or snapshots for storage.

Step 1 Select **Setting** > **Storage** > **Destination** > **Path**.

Figure 5-143 Path settings

Record				Snapshot			
Event Type	Scheduled	Motion Detection	Alarm	Event Type	Scheduled	Motion Detection	Alarm
Local	<input checked="" type="checkbox"/>	<input checked="" type="checkbox"/>	<input checked="" type="checkbox"/>	Local	<input checked="" type="checkbox"/>	<input checked="" type="checkbox"/>	<input checked="" type="checkbox"/>
FTP	<input type="checkbox"/>	<input type="checkbox"/>	<input type="checkbox"/>	FTP	<input type="checkbox"/>	<input type="checkbox"/>	<input type="checkbox"/>
NAS	<input type="checkbox"/>	<input type="checkbox"/>	<input type="checkbox"/>	NAS	<input type="checkbox"/>	<input type="checkbox"/>	<input type="checkbox"/>

Step 2 Select the corresponding event type and storage method as needed.

Table 5-45 Path parameter description

Parameter	Description
Event Type	Select Scheduled , Motion Detection or Alarm .
Local	Save recordings or snapshots to the SD card.
FTP	Save recordings or snapshots to the FTP server.
NAS	Save recordings or snapshots to the NAS server.

Step 3 Click **Save**.

5.6.3.2 FTP

FTP function can be enabled only when it is selected as a destination path. When the network is disconnected or does not work, you can save recordings and snapshots to the SD card by using **Emergency (Local)** function.

Step 1 Select **Setting > Storage > Destination > FTP**.

Figure 5-144 FTP settings

Step 2 Select the **Enable** check box, and the FTP function is enabled.



- There might be risks if the FTP function is enabled. Think twice before enabling the function.
- **SFTP** is recommended to ensure network security.

Step 3 Configure parameters as needed.

Table 5-46 FTP parameter description

Parameter	Description
Server Address	The IP address of the FTP server.
Port	The port number of the FTP server.
Username	The username to log in to the FTP server.
Password	The password to log in to the FTP server.
Remote Directory	The destination path on the FTP server.
Emergency (Local)	If you enable the function, in case of FTP storage exception, the recordings and snapshots will be stored on the local SD card.

Step 4 Click **test** to verify the username and password, and test whether FTP is connected to the Device.

Step 5 Click **Save**.

5.6.3.3 Local

SD card information is displayed in the local storage list. You can set it as read only or read & write. You can also hot swap or refresh it.

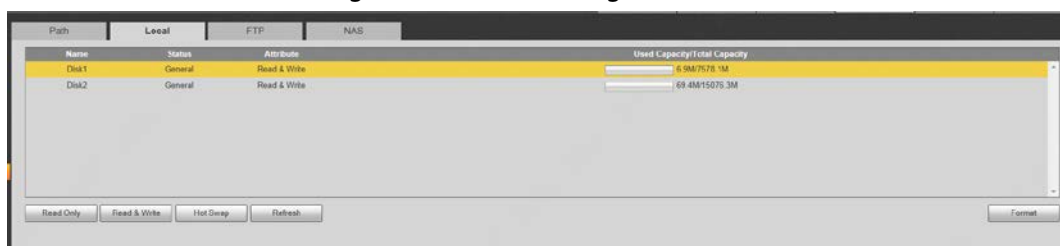


Dual SD cards are supported by some devices. For such devices, the SD card first inserted is called Local Disk 1, and the SD card inserted later is called Local Disk 2.

- If no recordings in both cards, the recording will be saved to Local Disk 1, and then saved to Local Disk 2 when Disk 1 is full.
- If there are recordings in both cards, the recording will be saved to the card with the latest recordings, and then saved to the other card when this card is full.

Step 1 Select **Setting > Storage > Destination > Local**.

Figure 5-145 Local storage



Step 2 Select the SD card to be set, and then perform the following operations as needed.

- Click **Read Only** to set the SD card to be read only.
- Click **Read & Write** to set the SD card to be read and write.
- Click **Hot Swap** to remove or insert the SD card when the Camera is running.
- Click **Format** to format the SD card.



After formatting the SD card, all data on it will be cleared. Be cautious.

5.6.3.4 NAS


This function can be enabled only when NAS is selected as a destination path. Select NAS to store files on the NAS server.

Step 1 Select **Setting > Storage > Destination > NAS**.

Figure 5-146 NAS settings

Step 2 Configure parameters as needed.

Table 5-47 NAS parameter description

Parameter	Description
Enable	Select the check box to enable NAS function. Select NFS or SMB function.  There might be risks if NFS or SMB is enabled. Think twice before enabling the function.
Server Address	The IP address of the NAS server.
Remote Directory	The destination path on the NAS server.

Step 3 Click **Save**.

5.6.4 Record Control

Step 1 Select **Setting > Storage > Record Control**.

Figure 5-147 Record control

Record Control

Pack Duration Min. (1~120)

Pre-event Record s (0~5)

Disk Full ▼

Record Mode Auto Manual Off

Record Stream ▼

Step 2 Configure parameters as needed.

Table 5-48 Record control parameter description

Parameter	Description
Pack Duration	Set the pack duration of each recording file. It is 30 minutes by default.
Pre-event Record	<p>Set the pre-recording time. For example, if you enter 5, when an alarm is triggered, the system reads the recording of the first 5 seconds in memory, and then records it into a file.</p> <p> If alarm recording or motion detection recording occurs, if there is no recording before, the video data within N seconds before the recording is started will also be recorded into the video file.</p>
Disk Full	<p>You can select Stop or Overwrite.</p> <ul style="list-style-type: none"> • Stop: The system stops recording when the disk is full. • Overwrite: The system overwrites the oldest files and keeps recording when the disk is full. <p> The data will be overwritten if the disk is full. Back up the file in time as needed.</p>
Record Mode	You can select Auto , Manual or Off . Select Manual mode to start recording immediately, and select Auto mode to record within the schedule.
Record Stream	Select Main Stream or Sub Stream .

Step 3 Click **Save**.

5.7 System Management

5.7.1 Device Settings

5.7.1.1 General


Step 1 Select **Setting > System > General > General**.

Figure 5-148 General settings

The screenshot shows a web interface for 'General' settings. At the top, there are two tabs: 'General' (active) and 'Date&Time'. Below the tabs, there are three input fields: 'Name' with the value '5C07BA7YAJ51BEB', 'Language' with a dropdown menu showing 'English', and 'Video Standard' with a dropdown menu showing 'PAL'. At the bottom of the form, there are three buttons: 'Default', 'Refresh', and 'Save'.

Step 2 Configure parameters as needed.

Table 5-49 General setting parameter description

Parameter	Description
Name	Set the device name.  Different devices have different names.
Language	Select the language to be displayed.
Video Standard	Select video standard from PAL and NTSC .

Step 3 Click **Save**.


5.7.1.2 Date & Time

Step 1 Select **Setting > System > General > Date&Time**.

Figure 5-149 Date & time

Step 2 Configure parameters as needed.

Table 5-50 Date & time parameter description

Parameter	Description
Date Format	Select the date format. Three formats are available: YYYY-MM-DD , MM-DD-YYYY and DD-MM-YYYY .
Time Format	Select the time format. Two formats are available: 24-Hour and 12-Hour .
Time Zone	Set the local time zone.
Current Time	The current time of the Device.
DST	Set the Start Time and End Time of DST in the Date format or Week format.
NTP	Select the NTP check box to enable the network time sync function.
Server	Set the address of the time server.  Set the network timing function of NTP server, and the Device time will be synchronized with the server time.
Port	Set the port number of the time server.
Interval	Set the synchronization interval of the Device and the time server.

Step 3 Click **Save**.

5.7.1.3 Screen Off Settings

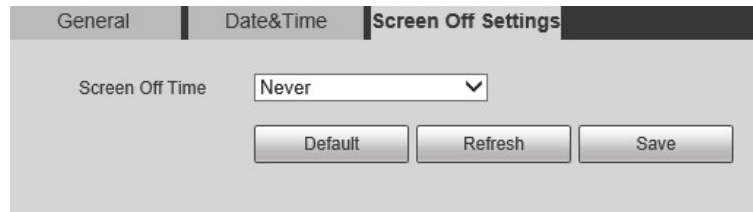


The function is available on select models.

You can set the screen-off time of the device display.

Step 1 Select **Setting > System > General > Screen Off Settings**.

Figure 5-150 Screen off settings



Step 2 Set screen-off time.

- **Never:** The screen is never turned off.
- **Custom:** Customize the screen-off time.

Step 3 Click **Save**.

5.7.2 Account Settings

5.7.2.1 Account

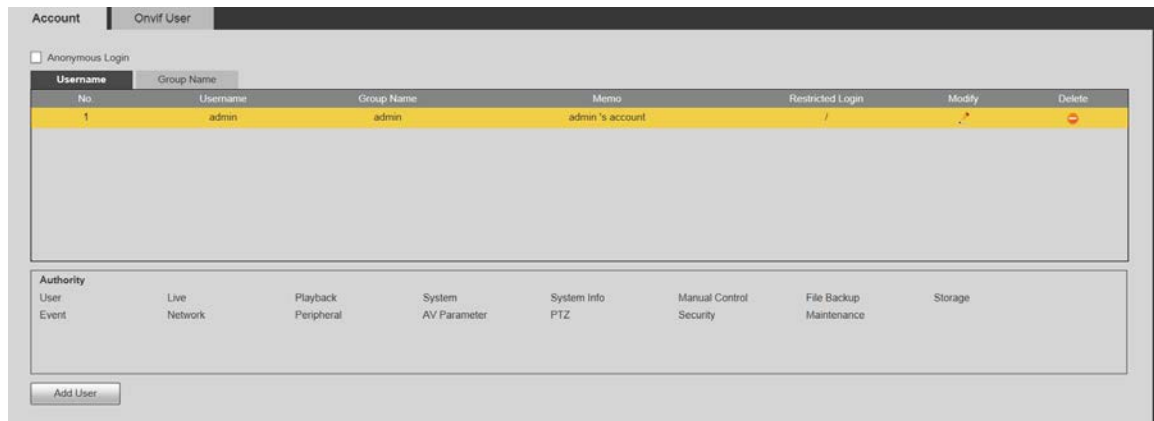
User management is only available for admin users.

- For **Username** and **Group Name**, the maximum length is 15 characters. Username can only consist of numbers, letters, underlines, dots and @; group name can only consist of numbers, letters and underlines.
- The password should consist of 8 to 32 non-blank characters and contain at least two types of characters among upper case, lower case, number, and special characters (excluding ' " ; : &). The confirming password shall be the same as the new password. Set a high security password according to the prompt of password strength.
- The number of users and groups is 19 and 8 respectively by default.
- User management adopts a two-level method of group and user. Neither group names nor user names can be duplicated, and a user can only belong to one group.
- Users currently logged in cannot modify their own permissions.
- The user is admin by default. The **admin** account is defined as high privileged user.

5.7.2.1.1 Username

Select **Setting > System > Account > Account > Username**, and you can enable anonymous login, add users, delete users, modify user passwords, and perform other operations.

Figure 5-151 Account interface



No permission is available for version information and other buttons except **Relay-out**, **Mark**, and **Wiper Control** on the **Live** interface for the time being.

Anonymous Login

Select the **Anonymous Login** check box, and you can log in to the Device anonymously without username and password after entering IP. Anonymous users only have preview permission in the permission list. In the anonymous login, click **Logout** to log in to the Device by using other usernames.



After **Anonymous Login** is enabled, the user can view audio and video data without authentication. Think twice before enabling the function.

Adding Users

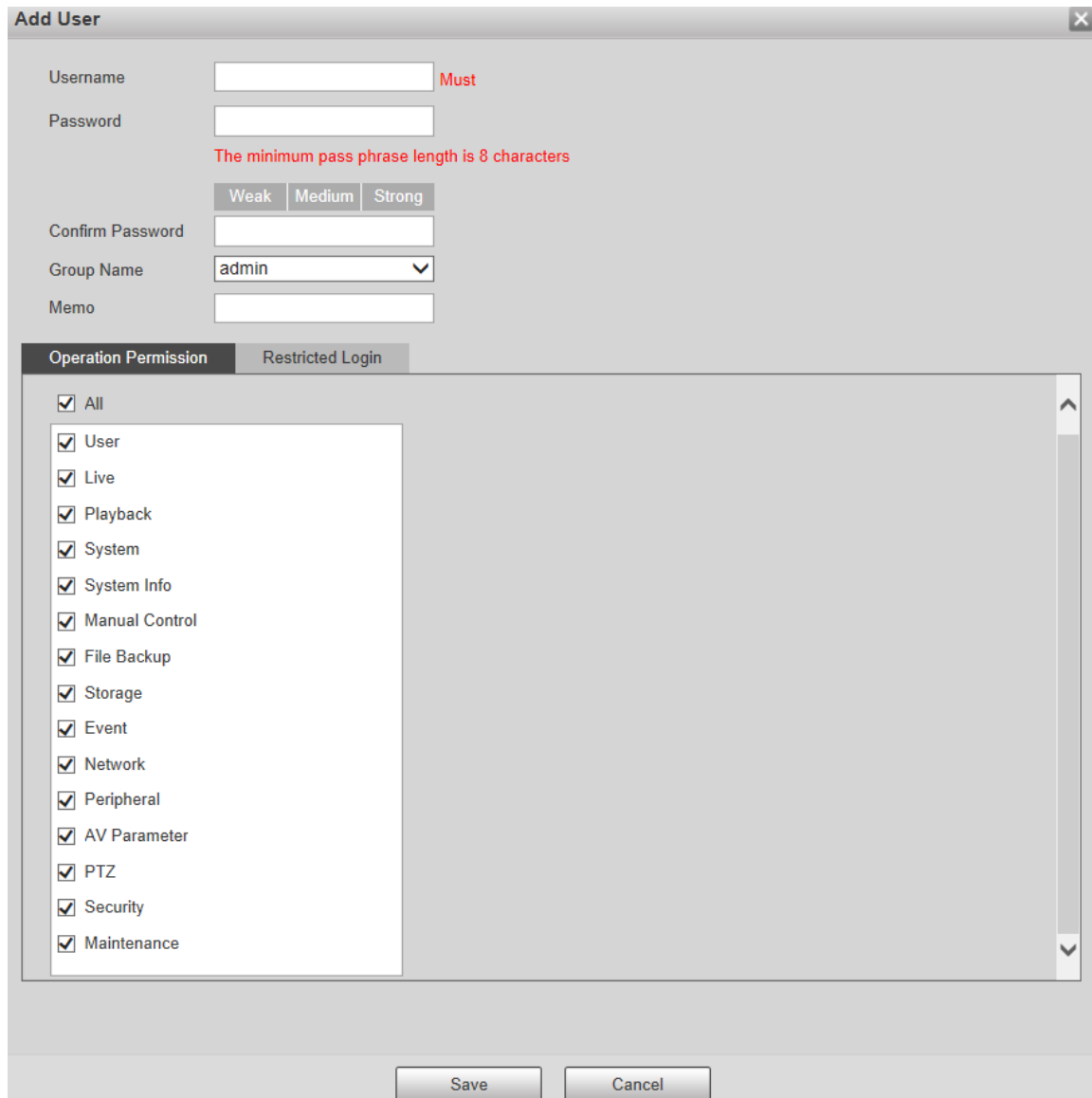
Add users in the group and set permissions.



As the default user with the highest authority, admin cannot be deleted.

Step 1 Click **Add User**.

Figure 5-152 Add users



Step 2 Enter **Username** and **Password**, confirm password, select **Group Name**, and then add **Memo**.

Step 3 Set **Operation Permission** and **Restricted Login**.

- Operation Permission: Click **Operation Permission**, and then select the operation permission of the user as needed.
- Restricted Login: **Click Restricted Login**, and the interface shown in Figure 5-153 is displayed. You can control login to the Device by setting the **IP Address**, **Validity Period** and **Time Range**.



- Once the group is selected as needed, the user permission can only be a subset of the group, and cannot exceed its permission attributes.
- It is recommended to give less permissions to general users than advanced users.

Figure 5-153 Restricted login

Step 4 Click **Save**.

Modifying Users

Step 1 Click  corresponding to the user you want to modify.

Figure 5-154 Modify users

Step 2 Modify user information as needed.

Step 3 Click **Save**.


Modifying Password

Step 1 Select the **Modify Password** check box.

Step 2 Enter old password and new password, and confirm password.

Step 3 Click **Save**.

Deleting Users

Click  corresponding to the user to be deleted, and the user can be deleted.

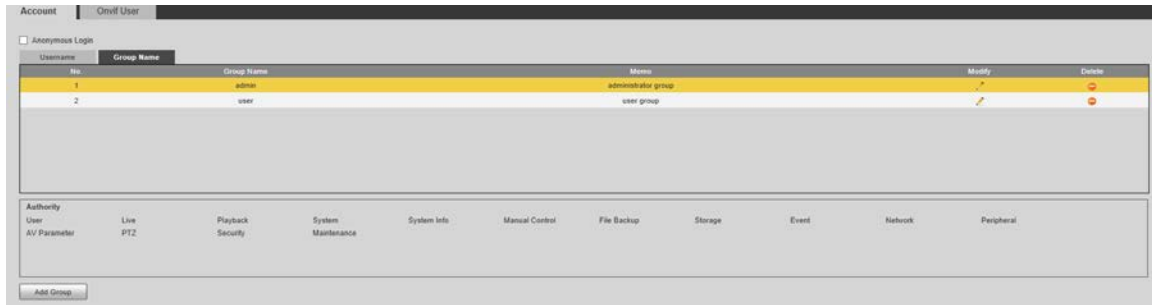


Users/user groups cannot be recovered after deletion. Think twice before performing the operation.

5.7.2.1.2 Group Name

Select **Setting > System > Account > Account > Group Name**, and you can add groups, delete groups, modify group passwords, and perform other operations.

Figure 5-155 User group settings



Configuring User Group

The default authorities of Admin group includes live, playback, storage, file backup, user, system, system info, manual control, maintenance, peripheral, PTZ, security, network, event and AV parameters; the default authorities of User group include live and playback.

Table 5-51 Description of user group parameters

Group Authority	Admin	User	Functions
User	YES	NA	Add, delete and check user/user group.
Live	YES	YES	Real-time stream view.
Playback	YES	YES	Playback view.
System	YES	NA	System time setting and more.
System Info	YES	NA	Version information, system logs and more.
Manual Control	YES	NA	PTZ settings.
File Backup	YES	NA	File backup.
Storage	YES	NA	Storage point configuration, snapshot recording time configuration, SFTP configuration and more.
Event	YES	NA	Video detection settings, audio detection settings, alarm settings and more.
Network	YES	NA	IP settings, SMTP settings, SNMP settings, AP Hotspot settings and more.
Peripheral	YES	NA	External light, wiper and serial port settings.
AV Parameter	YES	NA	Camera property settings, audio and video settings and more.
PTZ	YES	NA	Preset settings, tour settings and more.
Security	YES	NA	HTTPS settings, RTSP over TLS settings and more.
Maintenance	YES	NA	Automatic maintenance settings and more.



- Any user in the **Admin** group has **User** authority to modify group authority. The **User** group does not have this authority.
- The functions of the device correspond to the authority control respectively. Only user with specified authority can use corresponding function; the **Admin** group has all the authorities.

Adding Groups

For specific operations, refer to "5.7.2.1.1 Username".

Modifying Groups

For specific operations, refer to "5.7.2.1.1 Username".

Deleting Groups

For specific operations, refer to "5.7.2.1.1 Username".

5.7.2.2 Onvif User

On the web interface, you can add ONVIF users, or modify existing users.

Procedure

Step 1 Select **Setting > System > Account > Onvif User**.

Figure 5-156 Onvif user





Step 2 Click **Add User**.

Figure 5-157 Add users

Step 3 Set the username and password, confirm password, and then select the group name.

Step 4 Click **Save**.

Related Operations

- Click  to modify user information.
- Click  to delete users.

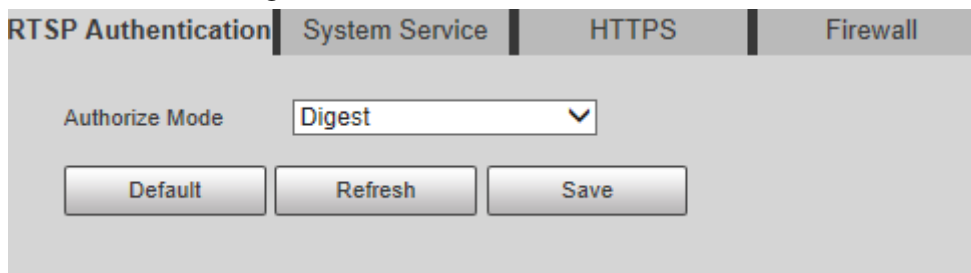
5.7.3 Safety

5.7.3.1 RTSP Authentication

Set the authentication method for media stream.

Step 1 Select **Setting > System > Safety > RTSP Authentication**.

Figure 5-158 RTSP authentication



Step 2 Select the **Authorize Mode**.

You can select from **Digest**, **Basic** and **None**. It is **Digest** by default.



- Click **Default**, and **Digest** is selected automatically.
- Select **None**, and "Non-authentication mode may have risk. Are you sure to enable it" prompt will be displayed. Think twice before selecting the mode.
- Select **Basic** mode, and "Basic authentication mode may have risk. Are you sure to enable it?" prompt will be displayed. Think twice before selecting the mode.

5.7.3.2 System Service





You can configure system service to ensure system security.




Step 1 Select **Setting > System > Safety > System Service**.

Figure 5-159 System service

Step 2 Configure system service parameters.

Table 5-52 System service parameter description

Function	Description
SSH	<p>You can enable SSH authentication to perform safety management. The function is disabled by default.</p>  <p>It is recommended to disable SSH. If this function is enabled, there might be security risks.</p>
Multicast/Broadcast Search	<p>Enable this function, and when multiple users are viewing the monitoring screen simultaneously through network, they can find the Device through multicast/broadcast protocol.</p>  <p>It is recommended to disable the multicast/broadcast search function. If this function is enabled, there might be security risks.</p>
Password Reset	<p>You can enable Password Reset to perform security management. The function is enabled by default.</p>  <p>If the function is disabled, you can only reset the password after restoring the Device to factory defaults through pressing the Reset button on the device.</p>
CGI Service	<p>You can access the Device through this protocol. The function is enabled by default.</p>  <p>It is recommended to disable the function. If this function is enabled, there might be security risks.</p>

Function	Description
Onvif Service	<p>You can access the Device through this protocol. The function is enabled by default.</p>  <p>It is recommended to disable the function. If this function is enabled, there might be security risks.</p>
Audio and Video Transmission Encryption	<p>Enable this function to encrypt the stream transmitted through the private protocol.</p>  <ul style="list-style-type: none"> • Make sure that the matched devices or software support video decryption function. • It is recommended to enable the function. If the function is disabled, there might be risk of data leakage.
Mobile Push	<p>Push the alarm snapshot triggered by the Device to the mobile phone. The function is enabled by default.</p>  <p>It is recommended to disable the function. If this function is enabled, there might be security risks.</p>
Private Protocol Authentication Mode	<p>You can select Security Mode and Compatible Mode. Security mode is recommended. If you select compatibility mode, there might be security risks.</p>

Step 3 Click **Save**.

5.7.3.3 HTTPS



It is recommended to enable HTTPS service. If the service is disabled, there might be risk of data leakage.

Create certificate or upload signed certificate, and then you can log in through HTTPS with your PC. HTTPS can ensure data security, and protect user information and device security with reliable and stable technology.

Step 1 Create certificate or upload the signed certificate.

- If you select **Create Certificate**, refer to the following steps.
 - 1) Select **Setting > System > Safety > HTTPS**.

Figure 5-160 HTTPS (1)

RTSP Authentication | System Service | **HTTPS** | Firewall

Enable HTTPS

Protocol Version

Enable TLSv1.0

Create Certificate

Request Created

Request Created

Install Signed Certificate

Certificate Path

Certificate Key Path

Certificate Installed

Certificate Installed

Attribute

- 2) Click **Create**.
The **HTTPS** dialog box is displayed.

Figure 5-161 HTTPS (2)

HTTPS [X]

Region *e.g. CN

IP or Domain name *

Validity Period Day*Range :1-5000

Province

Location

Organization

Organization Unit

Email

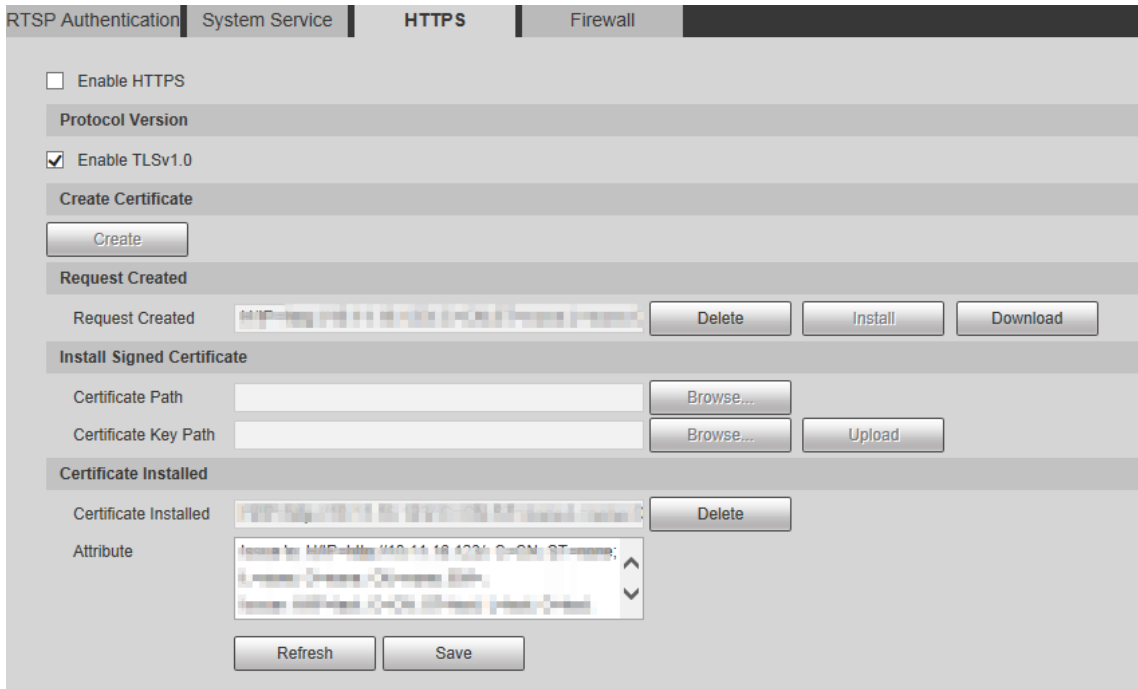
- 3) Enter the required information, and then click **Create**.



The entered IP or domain name must be the same as the IP or domain name of the Device.

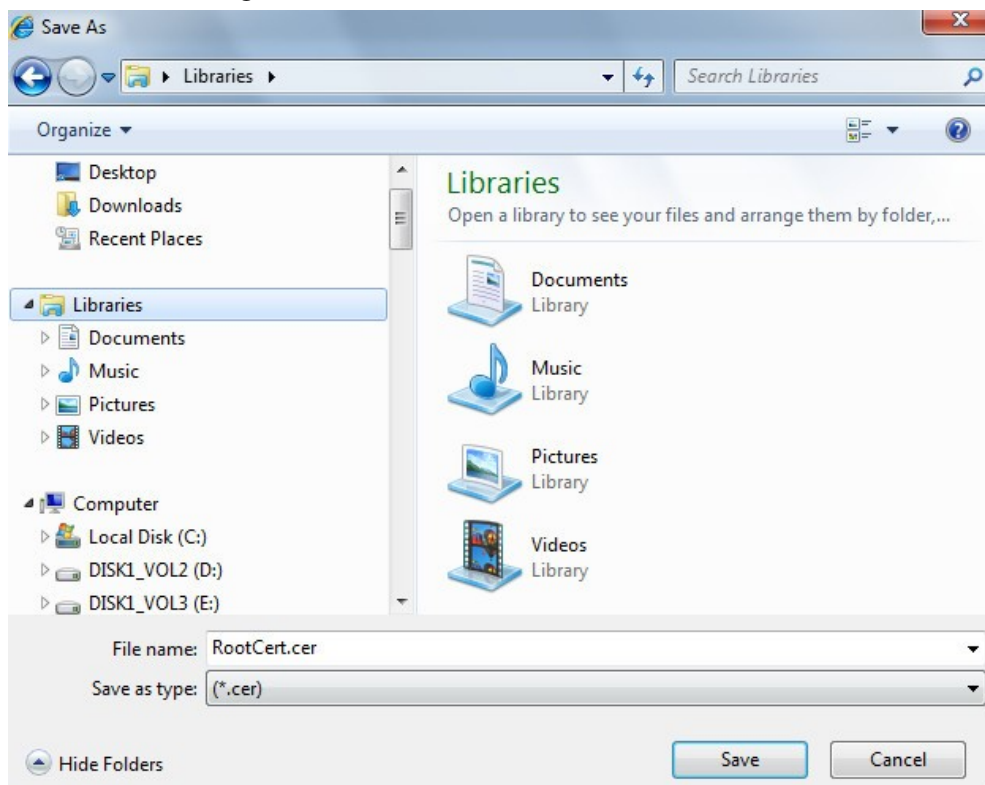
- 4) Click **Install** to install the certificate on the Device.

Figure 5-162 Certificate installation



- 5) Click **Download** to download root certificate.
The **Save As** dialog box is displayed.

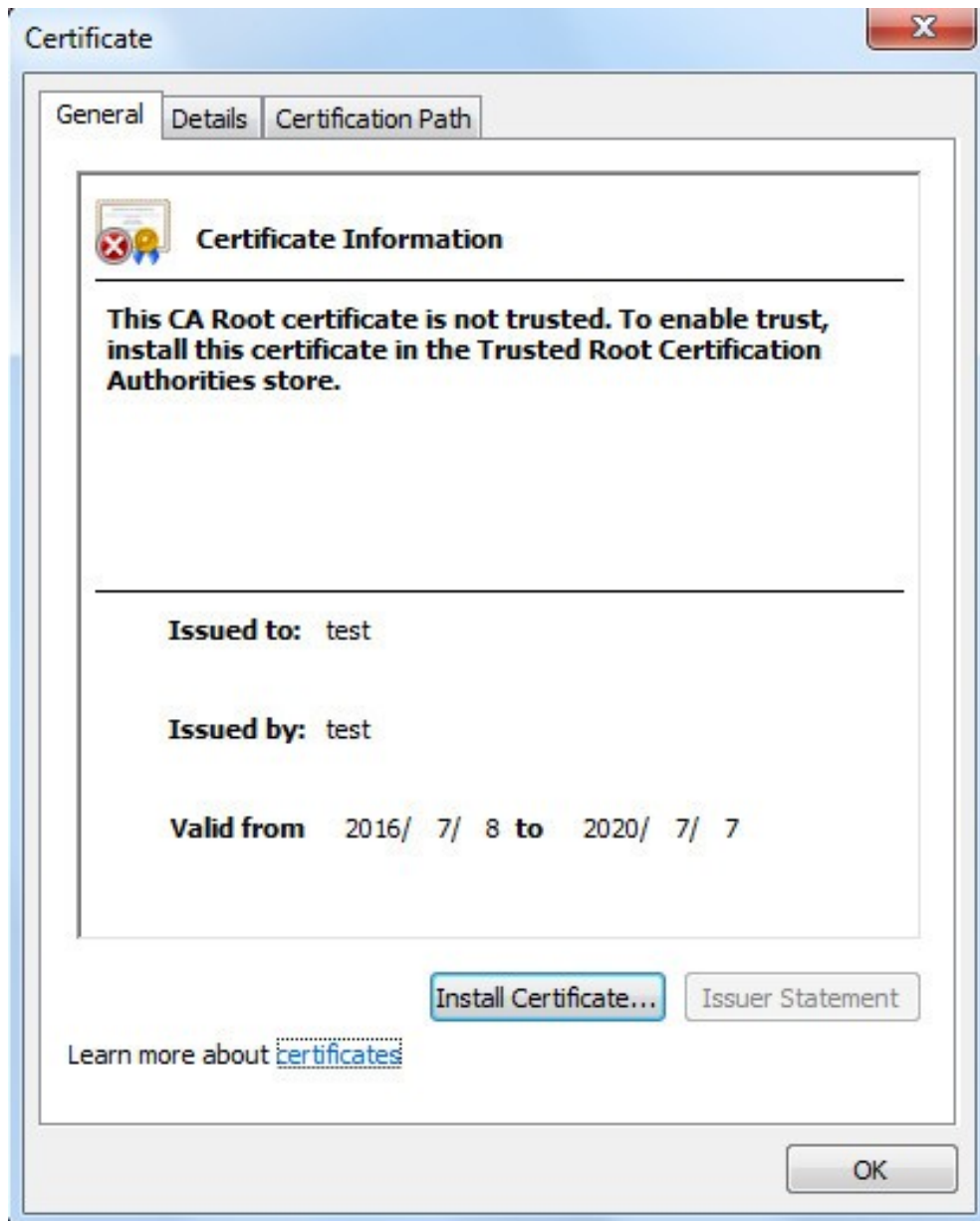
Figure 5-163 Download root certificate



- 6) Select storage path, and then click **Save**.

- 7) Double-click the **RootCert.cer** icon.
The **Certificate** interface is displayed.

Figure 5-164 Certificate information



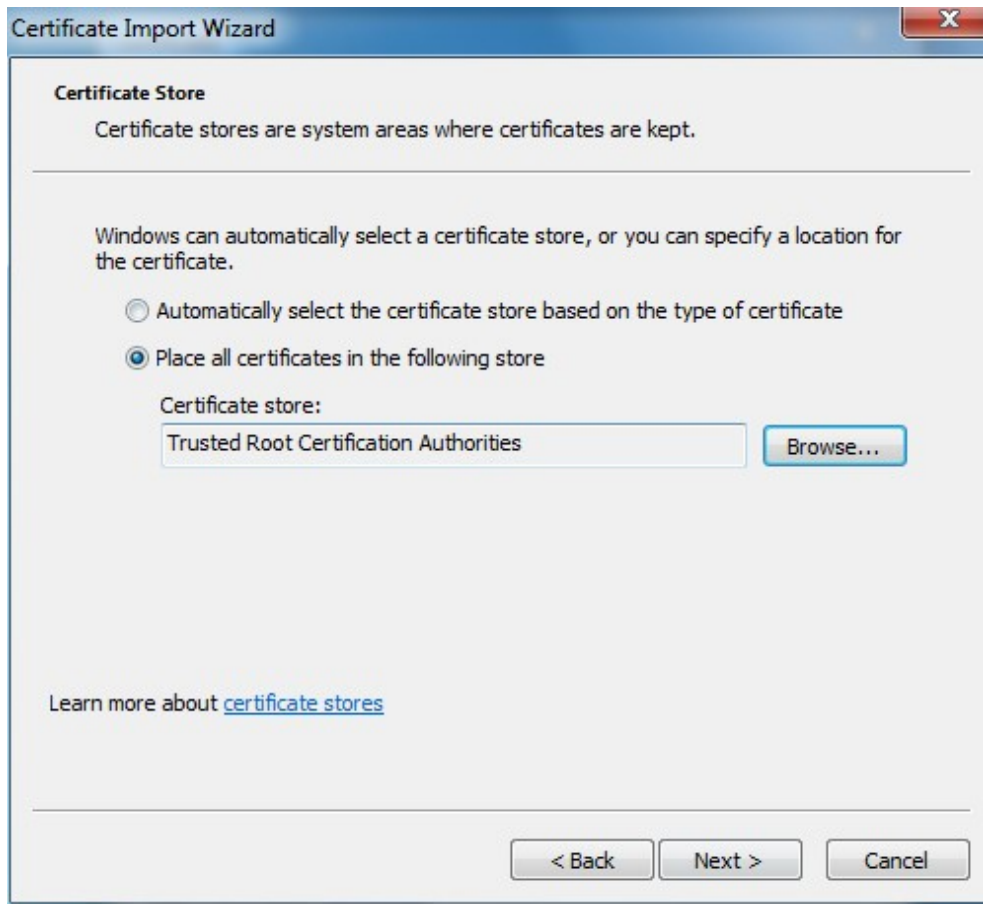
- 8) Click **Install Certificate**.
The **Certificate Import Wizard** interface is displayed.

Figure 5-165 Certificate import wizard



- 9) Click **Next**, and then select **Trusted Root Certification Authorities**.

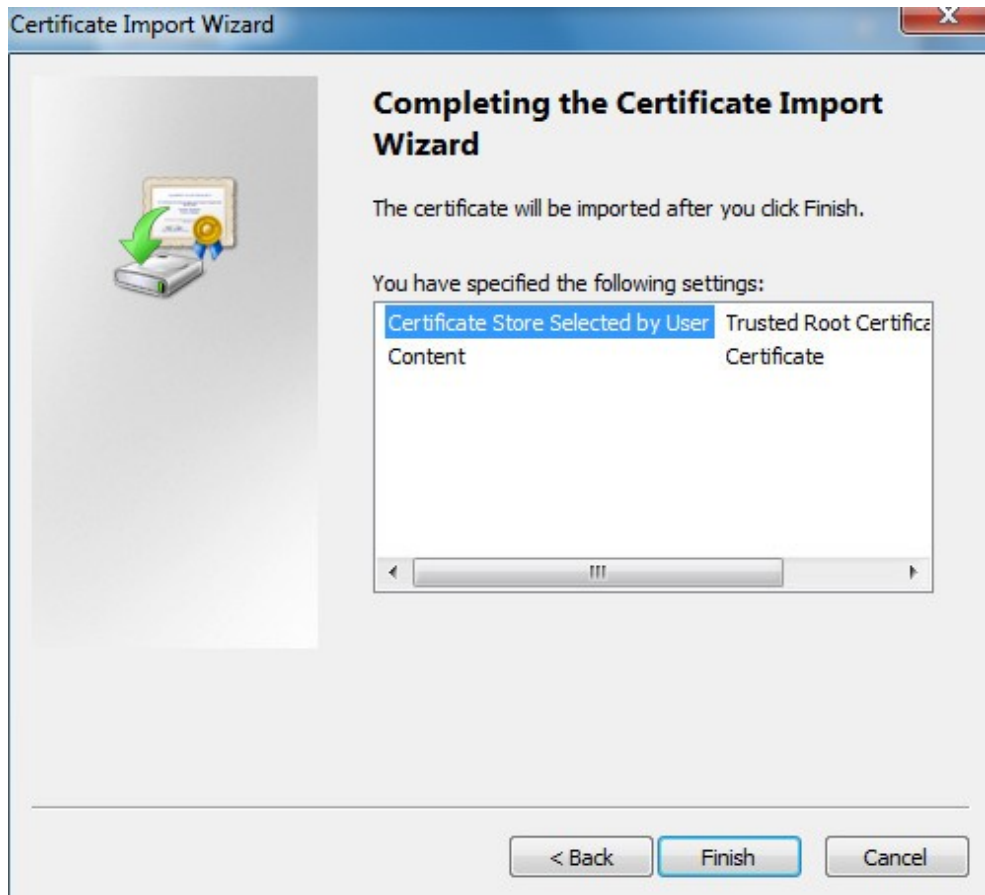
Figure 5-166 Certificate storage area



10) Click **Next**.

The **Completing the Certificate Import Wizard** interface is displayed.

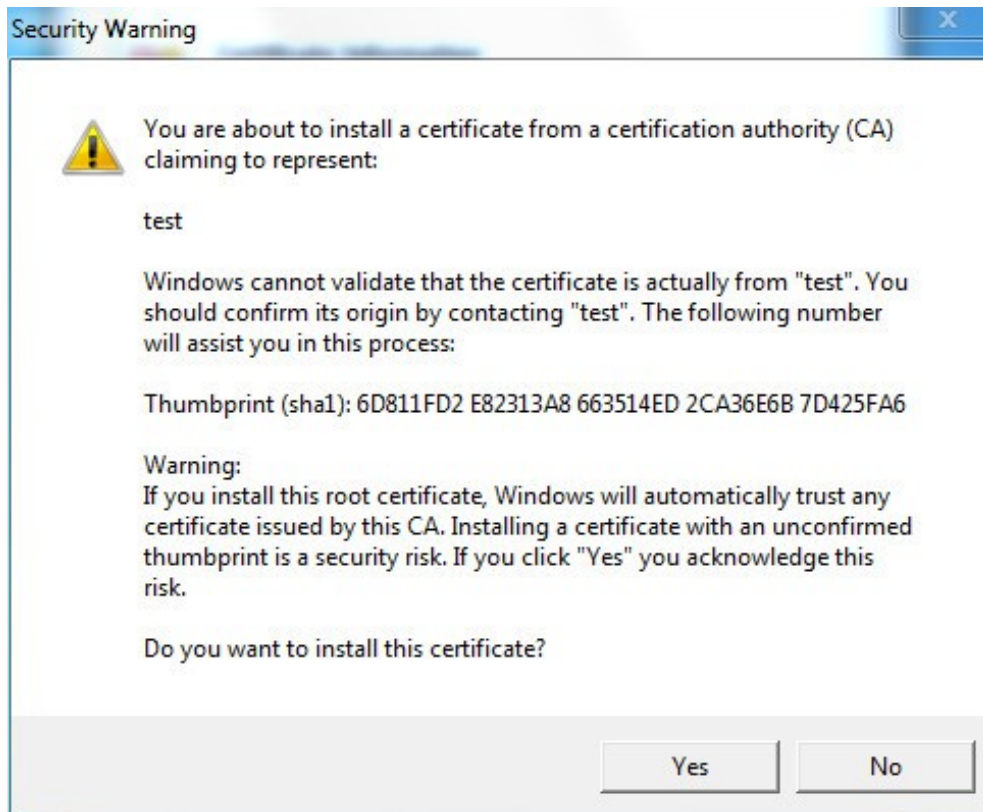
Figure 5-167 Completing the certificate import wizard



11) Click **Finish**.

The **Security Warning** dialog box is displayed.

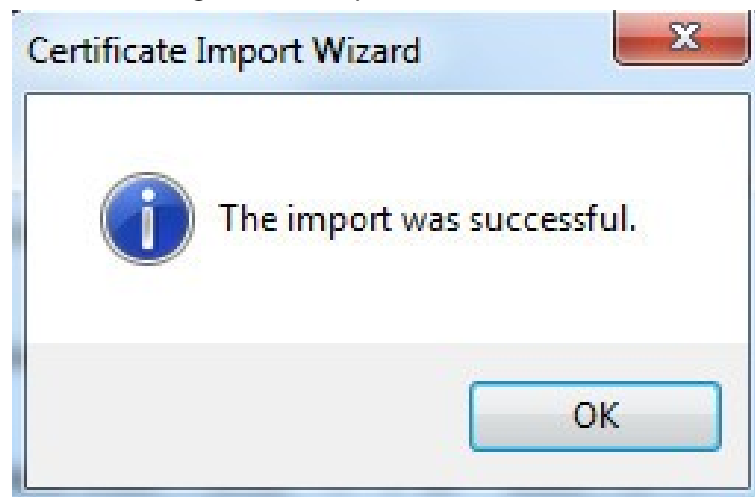
Figure 5-168 Security warning



12) Click **Yes**.

The import was successful dialog box is displayed. Click **OK** to complete the certificate installation.

Figure 5-169 Import success



- If you select **Install Signed Certificate**, refer to the following steps.

1) Select **Setting > System > Safety > HTTPS**.

The **HTTPS** interface is displayed.

Figure 5-170 Install signed certificate

- 2) Click **Browse** to upload the signed certificate and certificate key, and then click **Upload**.
- 3) Install the root certificate. For details, see 5) to 12) in [Step 1](#).

[Step 2](#) Select **Enable HTTPS**, and then click **Save**.

The **Reboot** interface is displayed, and the configuration takes effect after reboot.

Figure 5-171 Reboot

Enter `https://xx.xx.xx.xx` in the browser to open the login interface. If no certificate is installed, a certificate error prompt will be displayed.



- If HTTPS is enabled, you cannot access the Device through HTTP. The system will switch to HTTPS if you access the Device through HTTP.
- The deletion of created and installed certificates cannot be restored. Think twice before deleting them.

5.7.3.4 Firewall

Set a firewall for the Device to prevent network attacks after the Device is connected to the network.

[Step 1](#) Select **Setting > System > Safety > Firewall**.

Figure 5-172 Firewall

Step 2 Select the type of network attack that the firewall resists as needed. You can select **Network Access**, **PING Prohibited**, or **Prevent Semijoin**.

Step 3 Select **Enable**, and then the **Firewall** is enabled.

Step 4 Click **Save**.

5.7.4 Peripheral



The peripheral functions might vary with different models, and the actual interface shall prevail.

5.7.4.1 Wiper

Step 1 Select **Setting > System > Peripheral > Wiper**.

Figure 5-173 Wiper settings

Step 2 Configure parameters as needed.

Table 5-53 Wiper setting parameter description

Parameter	Description
Mode	Set the wiper mode. It is Manual by default. In Manual mode, you need to manually start the wiper.
Interval Time	The time between wiper starting to wiper ending.
Working Duration	Set the maximum duration of the wiper operating once in Manual mode. The value ranges from 10 minutes to 1440 minutes.

Step 3 Click **Save**.

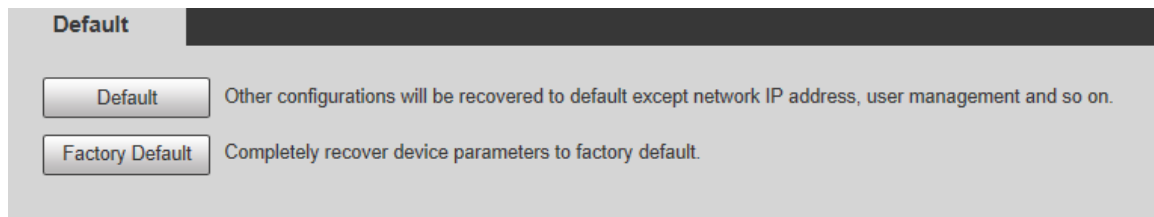
5.7.5 Default



All information except IP address and user management will be restored to defaults. Think twice before performing the operation.

Select **Setting > System > Default**, and click **Default** to restore the Device. The configuration interface is displayed.

Figure 5-174 Default interface



Select the recovery mode as needed.

- **Default:** All information except IP address and user management will be restored to defaults.
- **Factory Default:** The function is equivalent to the Reset button of the Device. All configuration information of the Device can be restored to the factory defaults, and the IP address can also be restored to the original IP address. After clicking **Factory Default**, you need to enter the password of admin user on the interface displayed. The Device can be restored to factory defaults only after the system confirms that the password is correct.



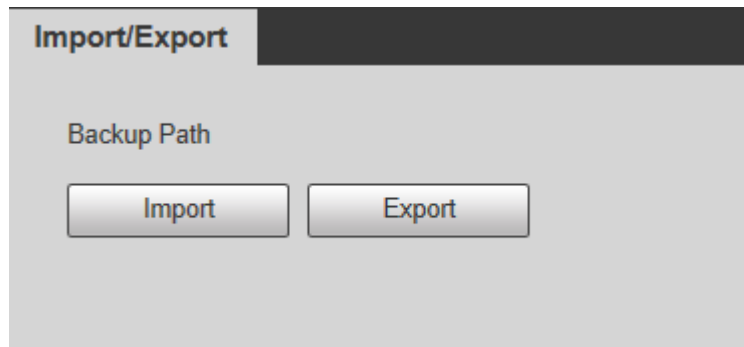
- Only admin user can use this function.
- When the Device is restored to factory defaults, all information except the data in the external storage media will be erased. Delete data in external storage media by formatting and other methods.

5.7.6 Import/Export

When multiple devices share the same configuration methods, they can be quickly configured by importing and exporting configuration files.

Step 1 On the web interface of one device, select **Setting > System > Import/Export**. The **Import/Export** interface is displayed. See Figure 5-175.

Figure 5-175 Import/Export



Step 2 Click **Export** to export the configuration file (.backup file) to the local storage path.

Step 3 Click **Import** on the **Import/Export** interface of the Device to be configured to import the configuration file, and the Device will complete the configurations.

5.7.7 System Maintenance

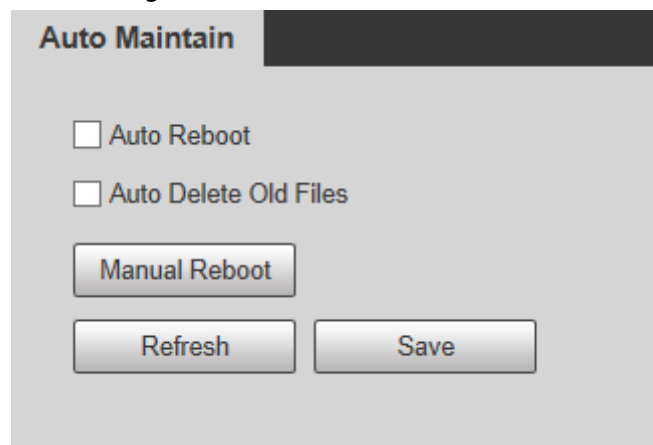
5.7.7.1 Auto Maintain

You can select **Auto Reboot** or **Auto Delete Old Files**.

- If you select **Auto Reboot**, the frequency and time need to be set.
- If you select **Auto Delete Old Files**, you need to set the time period for the files to be deleted.


Step 1 Select **Setting > System > Auto Maintain**.

Figure 5-176 Auto maintain



Step 2 Configure parameters as needed.

Table 5-54 Auto maintain parameter description

Parameter	Description
Auto Reboot	Select the check box to set the Device reboot time.
Auto Delete Old Files	Select the check box to customize the time period for the files to be deleted. The value ranges from 1 day to 31 days.  When you enable the function, The deleted files cannot be recovered. Are you sure to enable this function now? prompt will be displayed. Think twice before enabling the function.

Step 3 Click **Save** and the configuration will take effect.

5.7.7.2 Emergency Maintenance

By enabling emergency maintenance, you can fix most issues caused by upgrade and configuration.

Step 1 Select **Setting > System > Auto Maintain > Emergency Maintenance**.

Figure 5-177 Auto maintain



Step 2 Click **Save**.

5.7.8 Upgrade

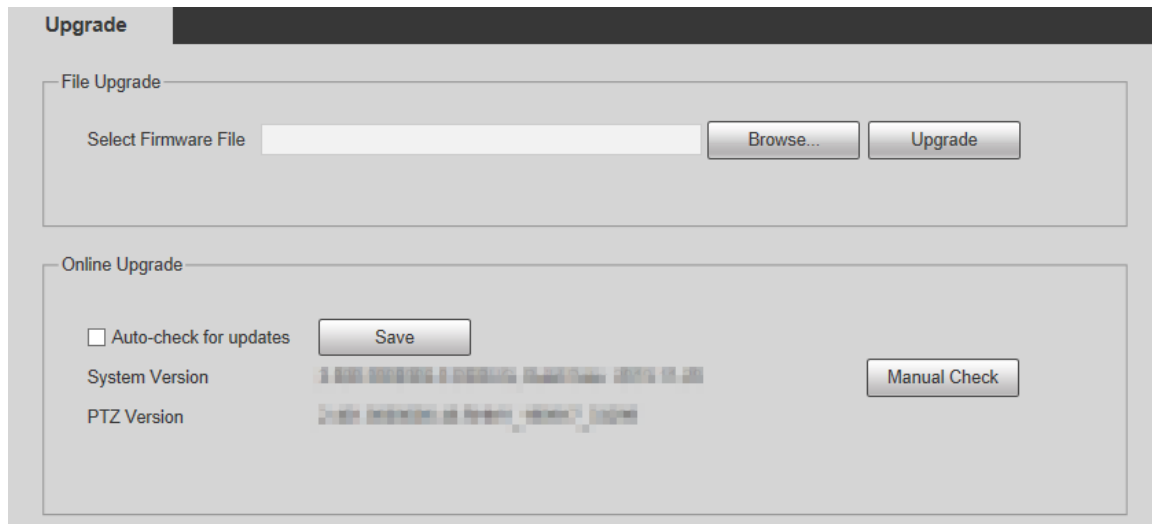
Upgrade the system to improve device function and stability.



If wrong upgrade file has been used, restart the Device; otherwise some functions might not work properly.

Select **Setting > System > Upgrade**. The configuration interface is displayed.

Figure 5-178 System upgrade



- File Upgrade: Click **Browse**, select the upgrade file, and then click **Upgrade** to upgrade the firmware. The upgrade file is in the format of *.bin.
- Online Upgrade
 1. Select the **Auto-check for updates** check box.
This will enable the system to check for upgrade once a day automatically, and there will be system notice if any upgrade is available.



We need to collect the data such as IP address, device name, firmware version, and device serial number to perform auto-check. The collected information is only used to verify the legitimacy of the Device, and push the upgrade notification.

2. Click **Save**.



Click **Manual Check**, and you can check for upgrade manually.

5.8 Information

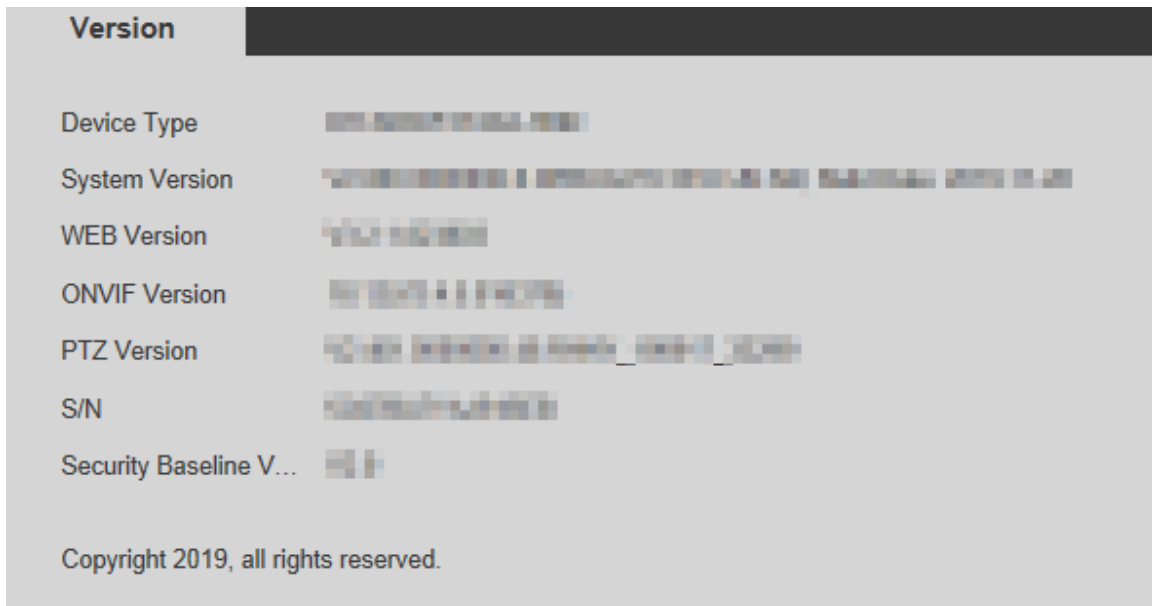
You can view information such as version, online users, log, and life statistics.

5.8.1 Version

You can view information such as system hardware features, software version and release date.

Select **Setting > Information > Version > Version**, and then you can see the version information of current web interface.

Figure 5-179 Version



5.8.2 Log Information

5.8.2.1 Log

Select **Setting** > **Information** > **Log** > **Log**, and then you can see the operation information of the Device, and some system information. See Figure 5-180. For parameter description, see Table 5-55.

Figure 5-180 Log

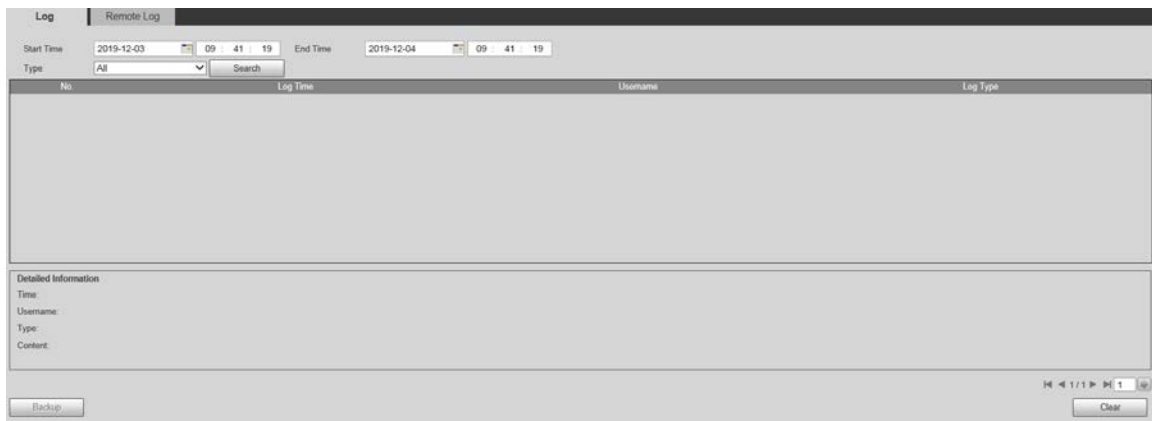



Table 5-55 Log parameter description

Parameter	Description
Start Time	The start time of the log to be searched (January 1, 2000 is the earliest time).
End Time	The end time of the log to be searched (December 31, 2037 is the latest time).
Type	The log type includes All, System, Setting, Data, Event, Record, Account, Clear Log, and Safety.

Parameter	Description
Search	Set the start time and end time of the log to be searched, select the log type, and then click Search . The searched log number and time period will be displayed.
Detailed Information	Click a log to display the details.
Clear	Clear all logs of the Device, and classified clearing is not supported.
Backup	Back up the searched system logs to the PC currently used by the user.  The data will be overwritten if the disk is full. Back up the data in time as needed.

Here are the meanings of different log types.

- **System:** Includes program launch, force exit, exit, program reboot, device shutdown/restart, system reboot, and system upgrade.
- **Setting:** Includes saving configurations, and deleting configuration files.
- **Data:** Includes disk type configurations, data erasing, hot swap, FTP state, and recording mode.
- **Event** (records events such as video detection, smart plan, alarm, and abnormality): Includes starting events, and ending events.
- **Record:** Includes file access, file access error, and file search.
- **Account** (records modification of user management, login, and logout): Includes login, logout, adding user, deleting user, modifying user, adding group, deleting group, and modifying group.
- **Safety:** Includes security-related information.
- **Clear Log:** Clearing logs.

5.8.2.2 Remote Log

Upload the Device operations to the log server.

Step 1 Select **Setting > Information > Log > Remote Log**.

Figure 5-181 Remote log

Step 2 Select **Enable**, and then remote log function is enabled.

Step 3 Set the **IP Address**, **Port** and **Device Number** of the log server.



Click **Default** to restore the Device to the default settings.

5.8.3 Online User

Select **Setting** > **Information** > **Online User**, and the **Online User** interface is displayed.

Figure 5-182 Online users

No.	Username	User Local Group	IP Address	User Login Time
1	admin	admin	192.168.1.100	2021-02-23 11:53:22

Refresh

5.8.4 Life Statistics

Select **Setting** > **Information** > **Life Statistics** to view the life statistics of the Device.



The function is available on select models.

Figure 5-183 Online users

Life Statistics	
Total Working Time	62 day(s) 1 hour(s) 0 minute(s)
Upgrade Times	20 time
Last Upgrade Date	2021-02-23 11:53:22

5.8.5 Battery Status

Select **Setting** > **Information** > **Battery Status** to view battery usage of the Device.



The function is available on select models.

Figure 5-184 Online users

Battery Status

Capacity Limit	100 %
Voltage	8.303 V
Charging or Not	No

Refresh

6 Alarm



You can select alarm types on the interface. When the selected alarms are triggered, detailed alarm information will be displayed on the right side of the interface. You can also select **Prompt** or **Play Alarm Tone**. When an alarm occurs, the alarm prompt or tone will be triggered. For the **Alarm** setting interface, see Figure 6-1. For parameter description, see Table 6-1.

Figure 6-1 Alarm setting interface



Table 6-1 Alarm setting parameter description

Category	Parameter	Description
Alarm Type	Motion Detection	Record alarm information in case of motion detection.
	Disk Full	Record alarm information in case of full disk.
	Disk Error	Record alarm information in case of disk error.
	Video Tamper	Record alarm information in case of video tampering.
	External Alarm	Record alarm information in case of an external alarm.
	Illegal Access	Record alarm information in case of illegal access.
	Audio Detection	Record alarm information in case of audio detection.
	IVS	Record alarm information in case of smart events.
	Scene Changing	Record alarm information in case of scene changing.
	Security Exception	Record alarm information in case of security exception.

Category	Parameter	Description
Operation	Prompt	<p>Select the Prompt check box. When you are not on the Alarm interface, and the selected alarm event is triggered, the Relay-out button on the main menu will change to , and the alarm information will be automatically recorded. After you click the Alarm menu bar, the button disappears.</p> <p></p> <p>If you are on the Alarm interface, there will be no image prompt when the selected alarm event is triggered, but the corresponding alarm information will be recorded in the alarm list on the right.</p>
	Play Alarm Tone	Select the check box, and then select the tone file path. When the selected alarm event is triggered, the selected tone file will be played to prompt you that an alarm event is triggered.
Alarm Tone	Tone Path	Customize the storage path for alarm tones.

7 Logout

Click **Logout** to log out, and the login interface is displayed. See Figure 7-1. Enter the username and password to log in again.

Figure 7-1 Login interface



Appendix 1 Cybersecurity Recommendations

Cybersecurity is more than just a buzzword: it's something that pertains to every device that is connected to the internet. IP video surveillance is not immune to cyber risks, but taking basic steps toward protecting and strengthening networks and networked appliances will make them less susceptible to attacks. Below are some tips and recommendations on how to create a more secured security system.

Mandatory actions to be taken for basic equipment network security:

1. Use Strong Passwords

Please refer to the following suggestions to set passwords:

- The length should not be less than 8 characters;
- Include at least two types of characters; character types include upper and lower case letters, numbers and symbols;
- Do not contain the account name or the account name in reverse order;
- Do not use continuous characters, such as 123, abc, etc.;
- Do not use overlapped characters, such as 111, aaa, etc.;

2. Update Firmware and Client Software in Time

- According to the standard procedure in Tech-industry, we recommend to keep your equipment (such as NVR, DVR, IP camera, etc.) firmware up-to-date to ensure the system is equipped with the latest security patches and fixes. When the equipment is connected to the public network, it is recommended to enable the "auto-check for updates" function to obtain timely information of firmware updates released by the manufacturer.
- We suggest that you download and use the latest version of client software.

"Nice to have" recommendations to improve your equipment network security:

1. Physical Protection

We suggest that you perform physical protection to equipment, especially storage devices. For example, place the equipment in a special computer room and cabinet, and implement well-done access control permission and key management to prevent unauthorized personnel from carrying out physical contacts such as damaging hardware, unauthorized connection of removable equipment (such as USB flash disk, serial port), etc.

2. Change Passwords Regularly

We suggest that you change passwords regularly to reduce the risk of being guessed or cracked.

3. Set and Update Passwords Reset Information Timely

The equipment supports password reset function. Please set up related information for password reset in time, including the end user's mailbox and password protection questions. If the information changes, please modify it in time. When setting password protection questions, it is suggested not to use those that can be easily guessed.

4. Enable Account Lock

The account lock feature is enabled by default, and we recommend you to keep it on to guarantee the account security. If an attacker attempts to log in with the wrong password several times, the corresponding account and the source IP address will be locked.

5. **Change Default HTTP and Other Service Ports**

We suggest you to change default HTTP and other service ports into any set of numbers between 1024~65535, reducing the risk of outsiders being able to guess which ports you are using.

6. **Enable HTTPS**

We suggest you to enable HTTPS, so that you visit Web service through a secure communication channel.

7. **MAC Address Binding**

We recommend you to bind the IP and MAC address of the gateway to the equipment, thus reducing the risk of ARP spoofing.

8. **Assign Accounts and Privileges Reasonably**

According to business and management requirements, reasonably add users and assign a minimum set of permissions to them.

9. **Disable Unnecessary Services and Choose Secure Modes**

If not needed, it is recommended to turn off some services such as SNMP, SMTP, UPnP, etc., to reduce risks.

If necessary, it is highly recommended that you use safe modes, including but not limited to the following services:

- SNMP: Choose SNMP v3, and set up strong encryption passwords and authentication passwords.
- SMTP: Choose TLS to access mailbox server.
- FTP: Choose SFTP, and set up strong passwords.
- AP hotspot: Choose WPA2-PSK encryption mode, and set up strong passwords.

10. **Audio and Video Encrypted Transmission**

If your audio and video data contents are very important or sensitive, we recommend that you use encrypted transmission function, to reduce the risk of audio and video data being stolen during transmission.

Reminder: encrypted transmission will cause some loss in transmission efficiency.

11. **Secure Auditing**

- Check online users: we suggest that you check online users regularly to see if the device is logged in without authorization.
- Check equipment log: By viewing the logs, you can know the IP addresses that were used to log in to your devices and their key operations.

12. **Network Log**

Due to the limited storage capacity of the equipment, the stored log is limited. If you need to save the log for a long time, it is recommended that you enable the network log function to ensure that the critical logs are synchronized to the network log server for tracing.

13. **Construct a Safe Network Environment**

In order to better ensure the safety of equipment and reduce potential cyber risks, we recommend:

- Disable the port mapping function of the router to avoid direct access to the intranet devices from external network.
- The network should be partitioned and isolated according to the actual network needs. If there are no communication requirements between two sub networks, it is suggested to use VLAN, network GAP and other technologies to partition the network, so as to achieve the network isolation effect.

- Establish the 802.1x access authentication system to reduce the risk of unauthorized access to private networks.
- Enable IP/MAC address filtering function to limit the range of hosts allowed to access the device.

ENABLING A SAFER SOCIETY AND SMARTER LIVING

ZHEJIANG DAHUA VISION TECHNOLOGY CO., LTD.

Address: No.1199 Bin'an Road, Binjiang District, Hangzhou, P. R. China | Website: www.dahuasecurity.com | Postcode: 310053

Email: overseas@dahuatech.com | Fax: +86-571-87688815 | Tel: +86-571-87688883

Network Speed Dome & PTZ Camera

Installation Manual



V1.0.0

Foreword

General






This manual introduces the precautions, installation preparations and cables of the Speed Dome & PTZ Camera (hereinafter referred to as "the Device").



Some specifications and metrics might not apply to all models, and the actual product shall prevail.

Safety Instructions

The following categorized signal words with defined meaning might appear in the manual.

Signal Words	Meaning
 DANGER	Indicates a high potential hazard which, if not avoided, will result in death or serious injury.
 WARNING	Indicates a medium or low potential hazard which, if not avoided, could result in slight or moderate injury.
 CAUTION	Indicates a potential risk which, if not avoided, could result in property damage, data loss, lower performance, or unpredictable result.
 TIPS	Provides methods to help you solve a problem or save you time.
 NOTE	Provides additional information as the emphasis and supplement to the text.

Revision History

Version	Revision Content	Release Time
V1.0.0	First release.	July 2020

About the Manual

- The manual is for reference only. If there is inconsistency between the manual and the actual product, the actual product shall prevail.
- We are not liable for any loss caused by the operations that do not comply with the manual.
- The manual would be updated according to the latest laws and regulations of related regions. For detailed information, see the paper manual, CD-ROM, QR code or our official website. If there is inconsistency between paper manual and the electronic version, the electronic version shall prevail.
- All the designs and software are subject to change without prior written notice. The product updates might cause some differences between the actual product and the manual. Please contact the customer service for the latest program and supplementary documentation.
- There still might be deviation in technical data, functions and operations description, or errors in print. If there is any doubt or dispute, please refer to our final explanation.
- Upgrade the reader software or try other mainstream reader software if the manual (in PDF format) cannot be opened.
- All trademarks, registered trademarks and the company names in the manual are the

properties of their respective owners.

- Please visit our website, contact the supplier or customer service if there is any problem occurred when using the Camera.
- If there is any uncertainty or controversy, please refer to our final explanation.

Important Safeguards and Warnings

The manual will help you to use the Device properly. Read the manual carefully before using the Device, and keep it well for future reference.

Operating Requirements

- Do not press hard, violently vibrate, and soak the Device when transporting and storing it. Complete package is necessary during the transportation. We will assume no responsibility for any damage or problem caused by incomplete package during the transportation.
- Protect the Device from falling down or heavy vibration.
- Buckle the safety hook before installing the Device if it is included.
- Keep the Device away from devices that generate electromagnetic field like televisions, radio transmitters, electromagnetic devices, electric machines, transformers, and speakers; otherwise image quality will be influenced.
- Keep the Device away from smoke, vapor, heat, and dust.
- Do not install the Device near heating furnace, spotlight, and other heat sources. If it is installed on ceiling, in kitchen or near boiler room, the Device temperature might rise.
- Do not disassemble the Device; otherwise it might cause dangers or device damage. Contact your local retailer or customer service center for internal setup or maintenance requirement.
- Make sure that there is no metal, or inflammable, explosive substance in the Device; otherwise it might cause fire, short-circuit, or other damage.
- Avoid sea water or rain eroding the Device.
- Avoid the lens aiming at intense light source, including sunlight and incandescent light; otherwise the lens might be damaged.
- It is recommended to use the Device with a lightning-proof device for better lightning-proof effect.
- Before installing the Device, you need to confirm the salt spray tolerance level. Do not install the Device in an environment with higher salt spray level than the Device can tolerate. There are three salt spray tolerance levels of cameras.
 - ◇ Devices with higher salt spray tolerance level can be installed in an area within 1500 m by the sea, or offshore platform.
 - ◇ Devices with medium salt spray tolerance level can be installed in an area 1500 m away from the sea.
 - ◇ Devices not salt spray tolerant can only be installed in an area 3000 m away from the sea.
- After unpacking, if the packing bag is damaged or leaking air, and the desiccant particles are of different colors, the normal use of the Device will not be affected.
- For the Device that supports laser, do not aim the laser directly at eyes. And keep a proper distance from the flammable to avoid fire.
- Contact your local retailer or customer service center if the Device is abnormal. Do not disassemble or repair the product by yourself. We will assume no responsibility for any problems caused by unauthorized modifications, disassembly or repair, incorrect installation or use, and overuse of certain components.

Power Requirements

- All installation and operations shall conform to local electrical safety regulations.
- Turn off the power and disconnect the power cord immediately if there is water or liquid falling into the Device. And contact your local retailer or customer service center.
- The power source shall conform to the requirement of the Safety Extra Low Voltage (SELV) standard, and supply power with rated voltage which conforms to Limited Power Source requirement according to IEC60950-1. Note that the power supply requirement is subject to the device label.
- Use the power adapter provided by legitimate manufacturers.
- Do not connect several cameras to one power adapter. It may result in overheat or fire if it exceeds the rated load.
- Make sure that the power is off when you connect the cables, and install or uninstall the Device.
- Turn off the power and disconnect the power cord immediately if there is any smoke, disgusting smell, or noise from the Device. And contact your local retailer or customer service center.

Cleaning Requirements

- Clean the enclosure with soft cloth. To remove the dirt, you can dip the soft cloth in proper detergent, wring the soft cloth out, and then dry the enclosure with soft cloth.
- Do not use gasoline, paint thinner or other chemicals to clean the enclosure; otherwise it might result in enclosure transfiguration or paint flake.
- Read all the manuals included before using chemical cloth. Avoid long time touch between the plastic or rubber material and the enclosure. It might result in device damage and paint flake.

Requirements for Installation and maintenance personnel

- Have certificates or experiences related to installation and maintenance of the closed-circuit television (CCTV).
- Have certificates related to working at height.
- Have basic knowledge and operation technique for low-voltage wiring and low-voltage electronic circuit connection.
- Have the ability to read and understand the manual.

Requirements for Lifting the Device

- Select appropriate tools to lift the Device.
- Make sure that the selected tools reach the installation height.
- Make sure that the selected tools have high safety performance.

Table of Contents

Foreword	I
Important Safeguards and Warnings	III
1 Installation Preparation	1
1.1 Basic Requirements.....	1
1.2 Installation Check	1
1.3 Cable Preparation	1
1.3.1 Video Cable Requirements	1
1.3.2 RS-485 Cable Requirements.....	2
1.3.3 Selecting Power Cable	2
1.3.3.1 Power Cable	2
1.3.3.2 PoE Power Cable	3
2 Cables	4
2.1 Cable Description.....	4
2.2 Cable Connection.....	5
2.2.1 Alarm Cable Connection	5
2.2.2 Thunder-Proof Cable Connection	6
2.2.2.1 Outdoor.....	6
2.2.2.2 Indoor.....	8
3 RS-485 Cable.....	10
3.1 Basic Features.....	10
3.2 Common Issues in Use	10
3.3 FAQ on RS-485 Cable	11
4 Wi-Fi Performance.....	12
5 Cable Diameter (24V AC) and Transmission Distance.....	13
6 Cable Diameter (12V DC) and Transmission Distance.....	14
7 Cable Diameter (24V DC) and Transmission Distance.....	15
8 Cable Diameter (30V DC) and Transmission Distance.....	16
9 Cable Diameter (36V DC) and Transmission Distance.....	18
10 Wire Gauge Reference Sheet.....	20
Appendix 1 Cybersecurity Recommendations	21

1 Installation Preparation

1.1 Basic Requirements

- All installation and operations shall conform to your local electrical safety regulations, fire protection regulations, and other relevant regulations.
- Make sure that the application scenario conforms to installation requirements. Contact your local retailer or customer service center if there is any problem.
- Use the Device according to the operating environment.
- Keep the original packing material well because you might need it to pack the Device and send it back for repair.

1.2 Installation Check

- Make sure that the place where the Device is installed has enough space to hold the Device and its mounting accessories.
- For PTZ cameras, make sure that the place where the Device is installed can sustain at least 4 times the weight of the Device and its mounting accessories; for speed domes, make sure that the ceiling and wall can sustain 8 times the weight of the Device and its mounting accessories.
- Do not install the Device at risky or unstable places.
- Make sure that the wall is thick enough to install expansion bolts (Users need to buy expansion bolts separately).
- For speed domes support intelligent tracking, illegal parking capture or laser, make sure that the mounting height is over 6 m.

1.3 Cable Preparation

Select the video cable depending on transmission distance.

1.3.1 Video Cable Requirements

- 75 ohm.
- Pure copper cored cables.
- 95% braided copper shielding.
- For cables applicable to network devices and their maximum transmission distance, see Table 1-1.
- For cables applicable to HDCVI devices and their maximum transmission distance, see Table 1-2.

Table 1-1 Cables and maximum transmission distance (network)

Model	Maximum Transmission Distance (ft/m)
RG59/U	750 ft/229 m
RG6/U	1,000 ft/305 m
RG11/U	1,500 ft/457 m

Table 1-2 Cables and maximum transmission distance (HDCVI)

Model	Maximum Transmission Distance (ft/m)
SYV-75-3	720P (25 fps/30 fps): 1,640 ft/500 m
	720P (50 fps/60 fps): 984 ft/300 m
	1080P (25 fps/30 fps): 984 ft/300 m

1.3.2 RS-485 Cable Requirements

When using 0.56 mm (24AWG) twisted-pair line, depending on different baud rates, the theoretical maximum transmission distance is different.

Table 1-3 Theoretical maximum transmission distance

Baud Rate	Maximum Transmission Distance
2400bps	1800 m
4800bps	1200 m
9600bps	800 m

The maximum transmission distance will be reduced in the following conditions: When thinner communication cables are used; the Device is used in places with intense electromagnetic interference; too many devices are connected to the RS-485 cable. Otherwise, maximum transmission distance will be increased.

1.3.3 Selecting Power Cable

1.3.3.1 Power Cable

Depending on the power cable specification, the same cable diameter corresponds to different transmission distance.

- For 24V AC power supply, see "5 Cable Diameter (24V AC) and Transmission Distance".
- For 12V DC power supply, see "6 Cable Diameter (12V DC) and Transmission Distance".
- For 24V DC power supply, see "7 Cable Diameter (24V DC) and Transmission Distance".
- For 30V DC power supply, see "8 Cable Diameter (30V DC) and Transmission Distance".
- For 36V DC power supply, see "9 Cable Diameter (36V DC) and Transmission Distance".

1.3.3.2 PoE Power Cable

Table 1-4 PoE power cable

POE Specification	Network Cable Specification
AF	CAT5E and network cables with higher standard.
AT	
HiPoE or BT	

2 Cables

2.1 Cable Description

The Device is equipped with a multi-functional combination cable by default, including power cord, video cable, audio cable, RS-485 control cable, alarm cable, network cable, and optical fiber cable. For details, see Figure 2-1.



The cables of different models vary, and the actual product shall prevail. The manual will introduce the cables as complete as possible.

Figure 2-1 Cables

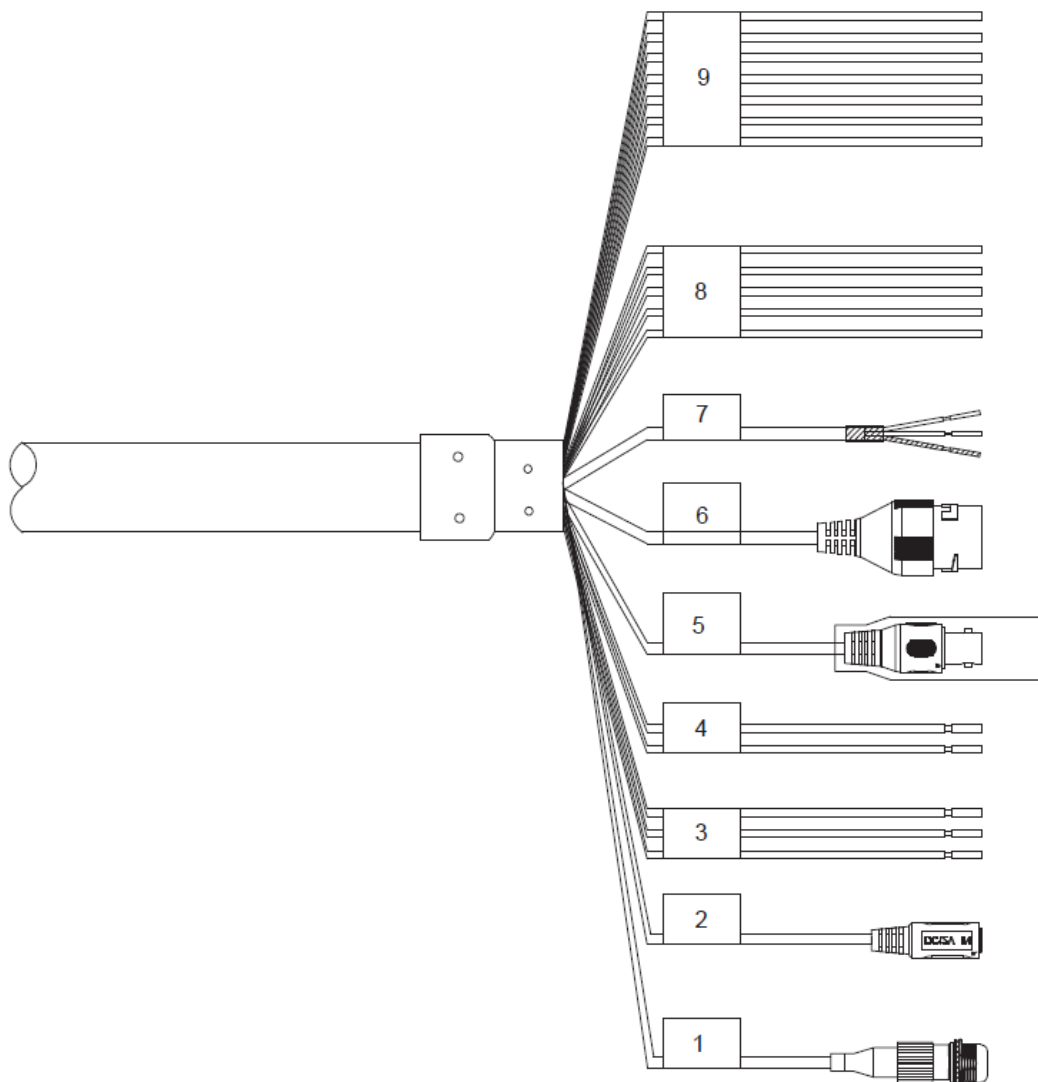


Table 2-1 Cable description

No.	Description
1	FC connector

No.	Description
2	DC power input port
3	24V AC power input <ul style="list-style-type: none"> ● Red: V+ ● Black: V- ● Yellow-green: Grounding cable
4	RS-485 <ul style="list-style-type: none"> ● Yellow: A+ ● Orange: B-
5	Video output port
6	Ethernet port
7	<ul style="list-style-type: none"> ● White: Audio input ● Red: Audio output ● Black: Audio grounding cable
8	<ul style="list-style-type: none"> ● Blue: Alarm output 1 ● Black: Alarm output 2 ● Green: Contact switch 1 ● Pink: Contact switch 2 ● Yellow-green: Grounding cable
9	<ul style="list-style-type: none"> ● Red: Alarm input 1 ● Brown: Alarm input 2 ● Grey: Alarm input 3 ● Light green: Alarm input 4 ● Purple: Alarm input 5 ● White: Alarm input 6 ● Yellow-black: Alarm input 7

2.2 Cable Connection

2.2.1 Alarm Cable Connection

- Step 1 Connect the alarm input device to ALARM_IN and ALARM_GND of the user cable.
- Step 2 Connect alarm output device to ALARM_OUT and ALARM_COM of the user cable, and alarm output is relay switch output.
- Step 3 Go to the web interface of the Device, and complete settings for alarm input and output devices. The alarm input on Web interface corresponds to the alarm input of the cables. Set the corresponding NO and NC output according to the high/low level signal generated by alarm input device when alarm is triggered.
- Step 4 Set the alarm output of cables on the web interface.

2.2.2 Thunder-Proof Cable Connection



The following installation figures are for reference only, and the actual product shall prevail.

This chapter takes PTZ camera as an example.

2.2.2.1 Outdoor

Transient voltage suppressor (TVS) is applied to protect the Device against voltage spikes and overvoltage below 6000V. However, it is still necessary to do operations to protect the Device according to actual conditions.

- The signal transmission cable must stay at least 50 m away from high voltage devices and high voltage wires.
- When laying cables outdoors, try to lay them under the eaves.
- At open places, lay cables underground by means of hermetic steel tube, and then do equipotential grounding to both ends of steel tubes. Laying overhead power cables are prohibited.
- At places with severe thunderstorms and induced voltage (like substation), you need to prepare high-powered lightning protection devices and lightning conductors.
- When laying cables and connecting lightning protection devices, you must comply with regional laws and regulations.
- You must do equipotential grounding to the electric system. The grounding device must meet the requirements of anti-jamming and conform to your local electrical safety code. The grounding device shall not form short circuit to N (neutral) line of high voltage power grid or be mixed with other wires. When the electrical system is connected to the ground cable, the impedance cannot exceed 4Ω and the cross-sectional area of the earth lead cannot exceed 25 mm^2 .

Figure 2-2 Installing lightning protection devices outdoors

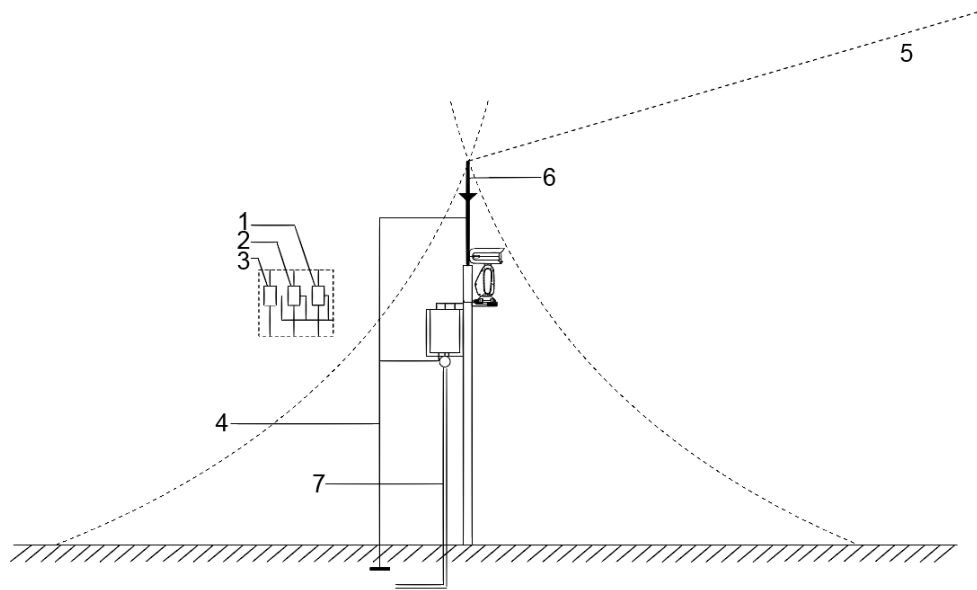
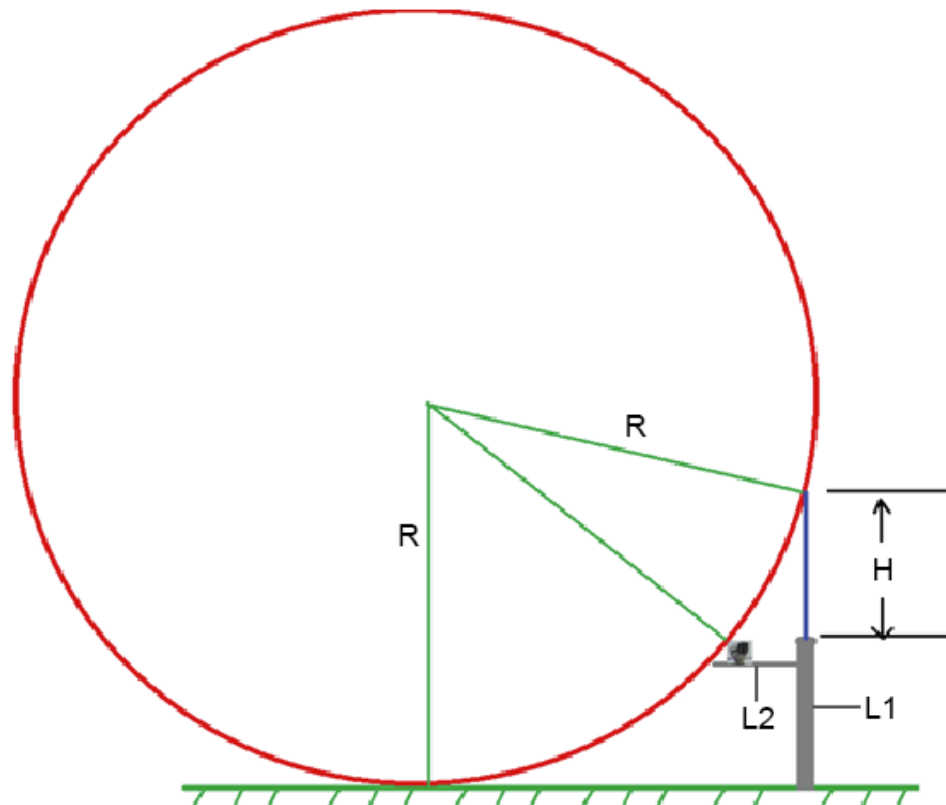


Table 2-2 Installing lightning protection devices outdoors

No.	Description
1	Video lightning conductor.
2	Communication lightning conductor.
3	Power supply lightning conductor.
4	Impedance of the cable connected to the grounding wire should be less than 4Ω.
5	The radius is 60 m.
6	Lightning conductor.
7	Steel tube.

Figure 2-3 Installing lightning protection devices outdoors (2)



- R: The radius of the circle, and R=60 m.
- L1: The length of the pole that holds the lightning conductor.
- L2: The length of the rail that holds the Device.
- H: The length of the lightning conductor.

To get the value of L1, you need to use the formula:

$$\left(\sqrt{R^2 - [R - (L1 + H)]^2} - L2\right)^2 + (R - L1)^2 = R^2$$

2.2.2.2 Indoor

You shall use multiple copper cables whose cross-sectional area is not less than 25 mm² to connect the yellow-green grounding cable/grounding screws to the indoor equipotential grounding terminals.

Figure 2-4 Installing lightning protection devices indoors

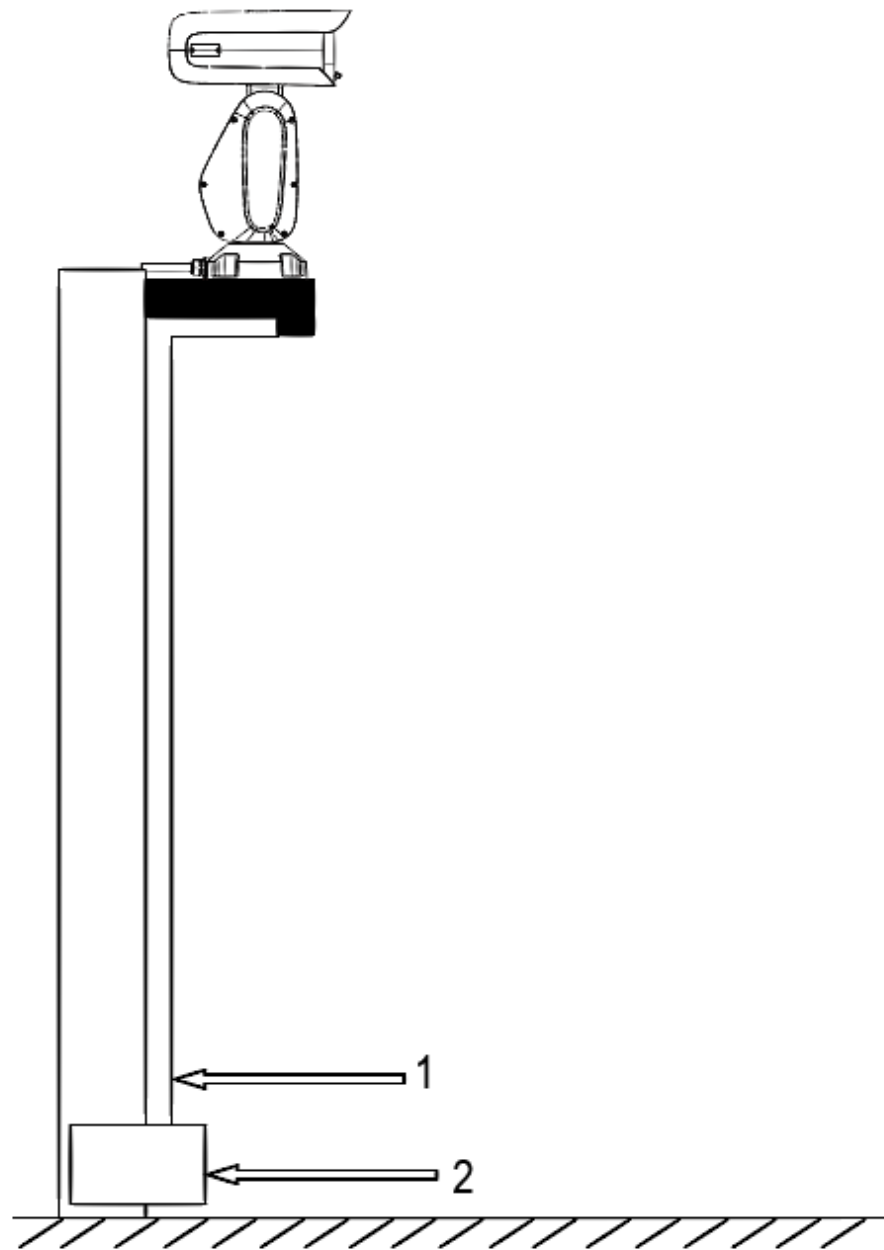


Table 2-3 Installing lightning protection devices indoors

No.	Name
1	Yellow-green grounding cable
2	Indoor equipotential grounding terminal

3 RS-485 Cable

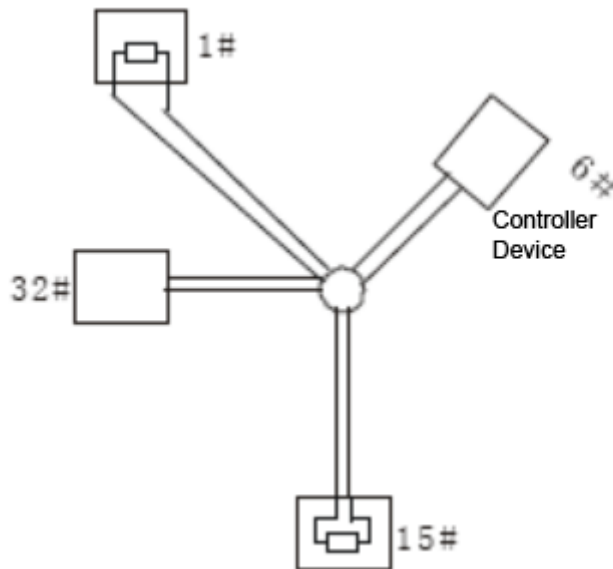
3.1 Basic Features

RS-485 industrial buses are half-duplex communication buses whose characteristic impedance is 120Ω . Its maximum load is 32 payloads (including controller devices and controlled devices).

3.2 Common Issues in Use

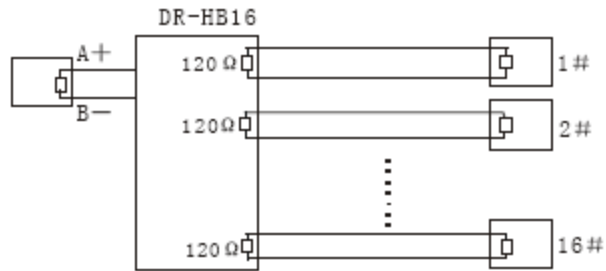
Users tend to connect devices as the way displayed in Figure 3-1. In this case, the terminal resistance must be connected to the two devices whose cable length is the longest among all the devices (in Figure 3-1, cable length between 1# and 15# is the longest). However, this connection manner does not comply with the RS-485 industrial standard. As a result, common issues like signal reflection and anti-interference capability reduction will occur. And the Device is out of control or cannot stop.

Figure 3-1 Common method to connect devices



To fix the issues, it is recommended to use RS-485 distributors. The RS-485 distributor can help avoid the common connection issues so as to improve transmission quality.

Figure 3-2 Connecting method with RS-485 distributors




3.3 FAQ on RS-485 Cable

Malfunction	Possible Reason	Solution
The Device can perform self-check, but is out of control.	Baud rate/address of the host and Device are not matched.	Modify the baud rate/address of the host or Device to be matched.
	Positive electrode and negative electrode of RS-485 cable are misconnected.	Connect cables to the positive electrode and negative electrode correctly.
	Loose connection.	Connect the cables firmly.
	RS-485 cable is broken.	Replace RS-485 cable.
The Device can be controlled, but the operation is not smooth.	RS-485 cable is in poor contact.	Connect the RS-485 cable firmly.
	RS-485 cable is broken.	Replace RS-485 cable.
	The distance between the host and the Device is too long.	Install terminal resistance.
	Too many cameras are connected parallely.	Install RS-485 distributors.

4 Wi-Fi Performance

Table 4-1 Wi-Fi performance description

Performance	Description	
Frequency band supported	2.4G; 5G	
Working channel (consistent with AP)	2.4G	CH1–CH13 (the actual working channel shall prevail).
	5G	The actual working channel shall prevail.
Transmission performance	<ul style="list-style-type: none"> • At open places without interference, if the Device is installed at least 1.5 m above the ground, the effective communication distance is 100 m. • In the environment without interference, the signal can pass through a load-bearing wall, and the effective communication distance is 20 m.  <p>The actual wall penetration capacity is greatly affected by network layout and actual environment.</p>	

5 Cable Diameter (24V AC) and Transmission Distance

The recommended transmission distances are for reference only, and the actual conditions shall prevail. The following table shows the maximum transmission distance of cables with certain diameter when the 24V AC power source voltage loss rate is below 10%.

For devices powered by alternating current, the maximum voltage loss rate allowed is 10%. For example, when a device of 20W rated power is installed 122 feet (37 m) away from the transformer, the minimum diameter needed is 0.80 mm.



In the following table, the unit for diameter is mm, and the unit for transmission distance is foot (m).

Table 5-1 Cable diameter (24V AC) and transmission distance

Transmission Power (W)	Transmission Distance (Diameter: 0.80)	Transmission Distance (Diameter: 1.00)	Transmission Distance (Diameter: 1.25)	Transmission Distance (Diameter: 2.00)
5	489 (149)	763 (233)	1193 (364)	3053 (931)
10	244 (74)	382 (116)	596 (182)	1527 (465)
15	163 (50)	254 (77)	398 (121)	1018 (310)
20	122 (37)	191 (58)	298 (91)	763 (233)
25	98 (30)	152 (47)	239 (73)	611 (186)
30	81 (25)	127 (39)	199 (61)	509 (155)
35	70 (21)	109 (33)	170 (52)	436 (133)
40	61 (19)	95 (29)	149 (45)	382 (116)
45	54 (16)	85 (26)	133 (41)	339 (103)
50	49 (15)	76 (23)	119 (36)	305 (93)
55	44 (13)	69 (21)	108 (33)	278 (85)
60	41 (12)	64 (20)	99 (30)	254 (77)
65	38 (12)	59 (18)	92 (28)	235 (72)
70	35 (11)	55 (17)	85 (26)	218 (66)
75	32 (10)	51 (16)	80 (24)	204 (62)
80	31 (9)	48 (15)	75 (23)	191 (58)
85	29 (9)	45 (14)	70 (21)	180 (55)
90	27 (8)	42 (13)	66 (20)	170 (52)
95	26 (8)	40 (12)	63 (19)	161 (49)
100	24 (7)	38 (12)	59 (18)	153 (47)

6 Cable Diameter (12V DC) and Transmission Distance

The recommended transmission distances are for reference only, and the actual conditions shall prevail. The following table shows the maximum transmission distance of cables with certain diameter when the 12V DC power source voltage loss rate is below 10%.

For devices powered by direct current, the maximum voltage loss rate allowed is 10%. The cables mentioned in the following table are all copper cables with electrical resistivity $\rho = 0.0175\Omega \times \text{mm}^2/\text{m}$.



In the following table, the unit for diameter is mm, and the unit for transmission distance is foot (m).

Table 6-1 Cable diameter (12V DC) and transmission distance

Transmission Power (W)	Transmission Distance (Diameter: 0.80)	Transmission Distance (Diameter: 1.00)	Transmission Distance (Diameter: 1.25)	Transmission Distance (Diameter: 2.00)
5	122 (37)	191 (58)	298 (91)	763 (233)
10	61 (19)	95 (29)	149 (45)	382 (116)
15	41 (12)	64 (20)	99 (30)	254 (77)
20	31 (9)	48 (15)	75 (23)	191 (58)
25	24 (7)	38 (12)	59 (18)	153 (47)
30	20 (6)	32 (10)	50 (15)	127 (39)
35	17 (5)	27 (8)	43 (13)	109 (33)
40	15 (5)	23 (7)	37 (11)	95 (29)
45	14 (4)	21 (6)	33 (10)	85 (26)
50	12 (4)	19 (6)	30 (9)	76 (23)
55	11 (3)	17 (5)	27 (8)	69 (21)
60	10 (3)	16 (5)	25 (8)	64 (20)
65	9 (3)	15 (5)	23 (7)	59 (18)
70	9 (3)	14 (4)	21 (6)	55 (17)
75	8 (2)	13 (4)	20 (6)	51 (16)
80	8 (2)	12 (4)	19 (6)	48 (15)
85	7 (2)	11 (3)	18 (5)	45 (14)
90	7 (2)	11 (3)	17 (5)	42 (13)
95	6 (2)	10 (3)	16 (5)	40 (12)
100	6 (2)	10 (3)	15 (5)	38 (12)

7 Cable Diameter (24V DC) and Transmission Distance

The recommended transmission distances are for reference only, and the actual conditions shall prevail. The following table shows the maximum transmission distance of cables with certain diameter when the 24V DC power source voltage loss rate is below 10%.

For devices powered by direct current, the maximum voltage loss rate allowed is 10%. The cables mentioned in the following table are all copper cables with electrical resistivity

$$\rho = 0.0175\Omega \times \text{mm}^2/\text{m}.$$



In the following table, the unit for diameter is mm, and the unit for transmission distance is foot (m).

Table 7-1 Cable diameter (24V DC) and transmission distance

Transmission Power (W)	Transmission Distance (Diameter: 0.80)	Transmission Distance (Diameter: 1.00)	Transmission Distance (Diameter: 1.25)	Transmission Distance (Diameter: 2.00)
5	489 (149)	763 (233)	1193 (364)	3053 (931)
10	244 (74)	382 (116)	596 (182)	1527 (465)
15	163 (50)	254 (77)	398 (121)	1018 (310)
20	122 (37)	191 (58)	298 (91)	763 (233)
25	98 (30)	153 (47)	239 (73)	611 (186)
30	81 (25)	127 (39)	199 (61)	509 (155)
35	70 (21)	109 (33)	170 (52)	436 (133)
40	61 (19)	95 (29)	149 (45)	382 (116)
45	54 (16)	85 (26)	133 (41)	339 (103)
50	49 (15)	76 (23)	119 (36)	305 (93)
55	44 (13)	69 (21)	108 (33)	278 (85)
60	41 (12)	64 (20)	99 (30)	254 (77)
65	38 (12)	59 (18)	92 (28)	235 (72)
70	35 (11)	55 (17)	85 (26)	218 (66)
75	33 (10)	51 (16)	80 (24)	204 (62)
80	31 (9)	48 (15)	75 (23)	191 (58)
85	29 (9)	45 (14)	70 (21)	180 (55)
90	27 (8)	42 (13)	66 (20)	170 (52)
95	26 (8)	40 (12)	63 (19)	161 (49)
100	24 (7)	38 (12)	60 (18)	153 (47)

8 Cable Diameter (30V DC) and Transmission Distance

The recommended transmission distances are for reference only, and the actual conditions shall prevail. The following table shows the maximum transmission distance of cables with certain diameter when the 30V DC power source voltage loss rate is below 20%. For devices powered by direct current, the maximum voltage loss rate allowed is 20%. For example, when a device of 150W rated power is installed 45 feet (14 m) away from the transformer, the minimum diameter needed is 0.80 mm.



In the following table, the unit for diameter is mm, and the unit for transmission distance is foot (m).

Table 8-1 Cable diameter (36V DC) and transmission distance

Transmission Power (W)	Transmission Distance (Diameter: 0.80)	Transmission Distance (Diameter: 1.00)	Transmission Distance (Diameter: 1.25)	Transmission Distance (Diameter: 2.00)
5	1357 (414)	2120 (646)	3313 (1010)	8481 (2585)
10	678 (207)	1060 (323)	1656 (505)	4241 (1293)
15	452 (138)	707 (215)	1104 (336)	2827 (862)
20	339 (103)	530 (162)	828 (252)	2120 (646)
25	271 (83)	424 (129)	663 (202)	1696 (517)
30	226 (69)	353 (108)	552 (168)	1414 (431)
35	194 (59)	303 (92)	473 (144)	1212 (369)
40	170 (52)	265 (81)	414 (126)	1060 (323)
45	151 (46)	236 (72)	368 (112)	942 (287)
50	136 (41)	212 (65)	331 (101)	848 (258)
55	123 (37)	193 (59)	301 (92)	771 (235)
60	113 (34)	177 (54)	276 (84)	707 (215)
65	104 (32)	163 (50)	255 (78)	652 (199)
70	97 (30)	151 (46)	237 (72)	606 (185)
75	90 (27)	141 (43)	221 (67)	565 (172)
80	85 (26)	133 (41)	207 (63)	530 (162)
85	80 (24)	125 (38)	195 (59)	499 (152)
90	75 (23)	118 (36)	184 (56)	471 (144)
95	71 (22)	112 (34)	174 (53)	446 (136)
100	68 (21)	106 (32)	166 (51)	424 (129)
100	68 (21)	106 (32)	166 (51)	424 (129)
110	62 (19)	96 (29)	151 (46)	386 (118)

Transmission Power (W)	Transmission Distance (Diameter: 0.80)	Transmission Distance (Diameter: 1.00)	Transmission Distance (Diameter: 1.25)	Transmission Distance (Diameter: 2.00)
120	57 (17)	88 (27)	138 (42)	353 (108)
130	52 (16)	82 (25)	127 (39)	326 (99)
140	48 (15)	76 (23)	118 (36)	303 (92)
150	45 (14)	71 (22)	110 (34)	283 (86)
160	42 (13)	66 (20)	104 (32)	265 (81)
170	40 (12)	62 (19)	97 (30)	249 (76)
180	38 (12)	59 (18)	92 (28)	236 (72)
190	36 (11)	56 (17)	87 (27)	223 (68)
200	34 (10)	53 (16)	83 (25)	212 (65)

9 Cable Diameter (36V DC) and Transmission Distance

The recommended transmission distances are for reference only, and the actual conditions shall prevail. The following table shows the maximum transmission distance of cables with certain diameter when the 36V DC power source voltage loss rate is below 25%. For devices powered by direct current, the maximum voltage loss rate allowed is 25%. For example, when a device of 150W rated power is installed 76 feet (23 m) away from the transformer, the minimum diameter needed is 0.80 mm.



In the following table, the unit for diameter is mm, and the unit for transmission distance is foot (m).

Table 9-1 Cable diameter (36V DC) and transmission distance

Transmission Power (W)	Transmission Distance (Diameter: 0.80)	Transmission Distance (Diameter: 1.00)	Transmission Distance (Diameter: 1.25)	Transmission Distance (Diameter: 2.00)
5	2290 (698)	3578 (1091)	5591 (1704)	14312 (4362)
10	1145 (349)	1789 (545)	2795 (852)	7156 (2181)
15	763 (233)	1193 (364)	1864 (568)	4771 (1454)
20	572 (174)	895 (273)	1398 (426)	3578 (1091)
25	458 (140)	716 (218)	1118 (341)	2862 (872)
30	382 (116)	596 (182)	932 (284)	2385 (727)
35	327 (100)	511 (156)	799 (244)	2045 (623)
40	286 (87)	447 (136)	699 (213)	1789 (545)
45	254 (77)	398 (121)	621 (189)	1590 (485)
50	229 (70)	358 (109)	559 (170)	1431 (436)
55	208 (63)	325 (99)	508 (155)	1301 (397)
60	191 (58)	298 (91)	466 (142)	1193 (364)
65	176 (54)	275 (84)	430 (131)	1101 (336)
70	164 (50)	256 (78)	399 (122)	1022 (312)
75	153 (47)	239 (73)	373 (114)	954 (291)
80	143 (44)	224 (68)	349 (106)	895 (273)
85	135 (41)	210 (64)	329 (100)	842 (257)
90	127 (39)	199 (61)	311 (95)	795 (242)
95	121 (37)	188 (57)	294 (90)	753 (230)
100	114 (35)	179 (55)	280 (85)	716 (218)
110	104 (32)	163 (50)	254 (77)	651 (198)
120	95 (29)	149 (45)	233 (71)	596 (182)

Transmission Power (W)	Transmission Distance (Diameter: 0.80)	Transmission Distance (Diameter: 1.00)	Transmission Distance (Diameter: 1.25)	Transmission Distance (Diameter: 2.00)
130	88 (27)	138 (42)	215 (66)	550 (168)
140	82 (25)	128 (39)	200 (61)	511 (156)
150	76 (23)	119 (36)	186 (57)	477 (145)
160	72 (22)	112 (34)	175 (53)	447 (136)
170	67 (20)	105 (32)	164 (50)	421 (128)
180	64 (20)	99 (30)	155 (47)	398 (121)
190	60 (18)	94 (29)	147 (45)	377 (115)
200	57 (17)	89 (27)	140 (43)	358 (109)

10 Wire Gauge Reference Sheet

Metric Bare Wire Diameter (mm)	AWG	SWG	Bare Wire Cross Section Area (mm ²)
0.050	43	47	0.00196
0.060	42	46	0.00283
0.070	41	45	0.00385
0.080	40	44	0.00503
0.090	39	43	0.00636
0.100	38	42	0.00785
0.110	37	41	0.00950
0.130	36	39	0.01327
0.140	35	/	0.01539
0.160	34	37	0.02011
0.180	33	/	0.02545
0.200	32	35	0.03142
0.230	31	/	0.04115
0.250	30	33	0.04909
0.290	29	31	0.06605
0.330	28	30	0.08553
0.350	27	29	0.09621
0.400	26	28	0.1257
0.450	25	/	0.1602
0.560	24	24	0.2463
0.600	23	23	0.2827
0.710	22	22	0.3958
0.750	21	/	0.4417
0.800	20	21	0.5027
0.900	19	20	0.6362
1.000	18	19	0.7854
1.250	16	18	1.2266
1.500	15	/	1.7663
2.000	12	14	3.1420
2.500	/	/	4.9080
3.000	/	/	7.0683

Appendix 1 Cybersecurity Recommendations

Cybersecurity is more than just a buzzword: it's something that pertains to every device that is connected to the internet. IP video surveillance is not immune to cyber risks, but taking basic steps toward protecting and strengthening networks and networked appliances will make them less susceptible to attacks. Below are some tips and recommendations on how to create a more secured security system.

Mandatory actions to be taken for basic equipment network security:

1. Use Strong Passwords

Please refer to the following suggestions to set passwords:

- The length should not be less than 8 characters;
- Include at least two types of characters; character types include upper and lower case letters, numbers and symbols;
- Do not contain the account name or the account name in reverse order;
- Do not use continuous characters, such as 123, abc, etc.;
- Do not use overlapped characters, such as 111, aaa, etc.;

2. Update Firmware and Client Software in Time

- According to the standard procedure in Tech-industry, we recommend to keep your equipment (such as NVR, DVR, IP camera, etc.) firmware up-to-date to ensure the system is equipped with the latest security patches and fixes. When the equipment is connected to the public network, it is recommended to enable the "auto-check for updates" function to obtain timely information of firmware updates released by the manufacturer.
- We suggest that you download and use the latest version of client software.

"Nice to have" recommendations to improve your equipment network security:

1. Physical Protection

We suggest that you perform physical protection to equipment, especially storage devices. For example, place the equipment in a special computer room and cabinet, and implement well-done access control permission and key management to prevent unauthorized personnel from carrying out physical contacts such as damaging hardware, unauthorized connection of removable equipment (such as USB flash disk, serial port), etc.

2. Change Passwords Regularly

We suggest that you change passwords regularly to reduce the risk of being guessed or cracked.

3. Set and Update Passwords Reset Information Timely

The equipment supports password reset function. Please set up related information for password reset in time, including the end user's mailbox and password protection questions. If the information changes, please modify it in time. When setting password protection questions, it is suggested not to use those that can be easily guessed.

4. Enable Account Lock

The account lock feature is enabled by default, and we recommend you to keep it on to guarantee the account security. If an attacker attempts to log in with the wrong password several times, the corresponding account and the source IP address will be locked.

5. Change Default HTTP and Other Service Ports

We suggest you to change default HTTP and other service ports into any set of numbers between 1024~65535, reducing the risk of outsiders being able to guess which ports you

are using.

6. **Enable HTTPS**

We suggest you to enable HTTPS, so that you visit Web service through a secure communication channel.

7. **Enable Whitelist**

We suggest you to enable whitelist function to prevent everyone, except those with specified IP addresses, from accessing the system. Therefore, please be sure to add your computer's IP address and the accompanying equipment's IP address to the whitelist.

8. **MAC Address Binding**

We recommend you to bind the IP and MAC address of the gateway to the equipment, thus reducing the risk of ARP spoofing.

9. **Assign Accounts and Privileges Reasonably**

According to business and management requirements, reasonably add users and assign a minimum set of permissions to them.

10. **Disable Unnecessary Services and Choose Secure Modes**

If not needed, it is recommended to turn off some services such as SNMP, SMTP, UPnP, etc., to reduce risks.

If necessary, it is highly recommended that you use safe modes, including but not limited to the following services:

- SNMP: Choose SNMP v3, and set up strong encryption passwords and authentication passwords.
- SMTP: Choose TLS to access mailbox server.
- FTP: Choose SFTP, and set up strong passwords.
- AP hotspot: Choose WPA2-PSK encryption mode, and set up strong passwords.

11. **Audio and Video Encrypted Transmission**

If your audio and video data contents are very important or sensitive, we recommend that you use encrypted transmission function, to reduce the risk of audio and video data being stolen during transmission.

Reminder: encrypted transmission will cause some loss in transmission efficiency.

12. **Secure Auditing**

- Check online users: we suggest that you check online users regularly to see if the device is logged in without authorization.
- Check equipment log: By viewing the logs, you can know the IP addresses that were used to log in to your devices and their key operations.

13. **Network Log**

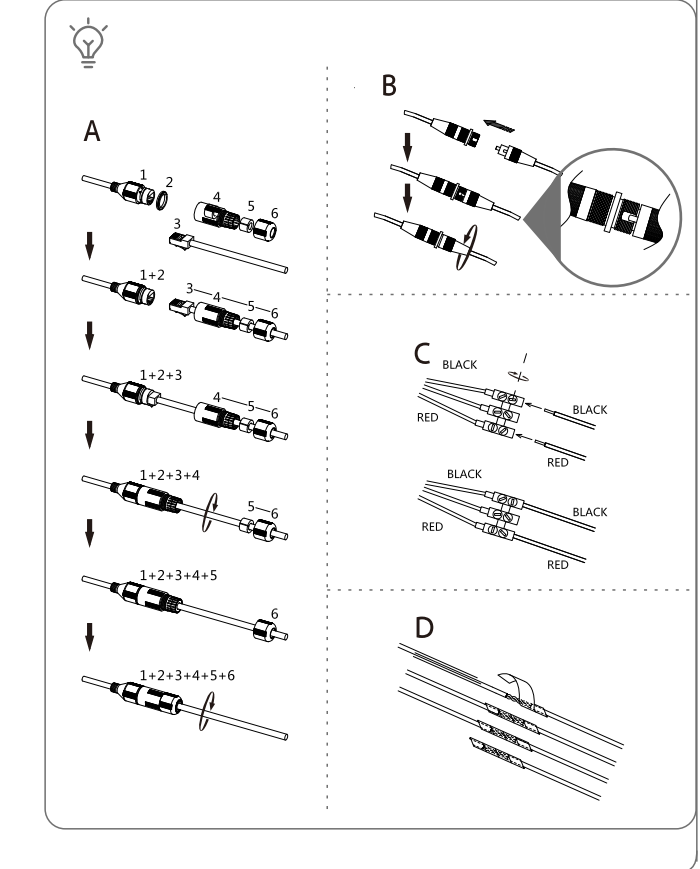
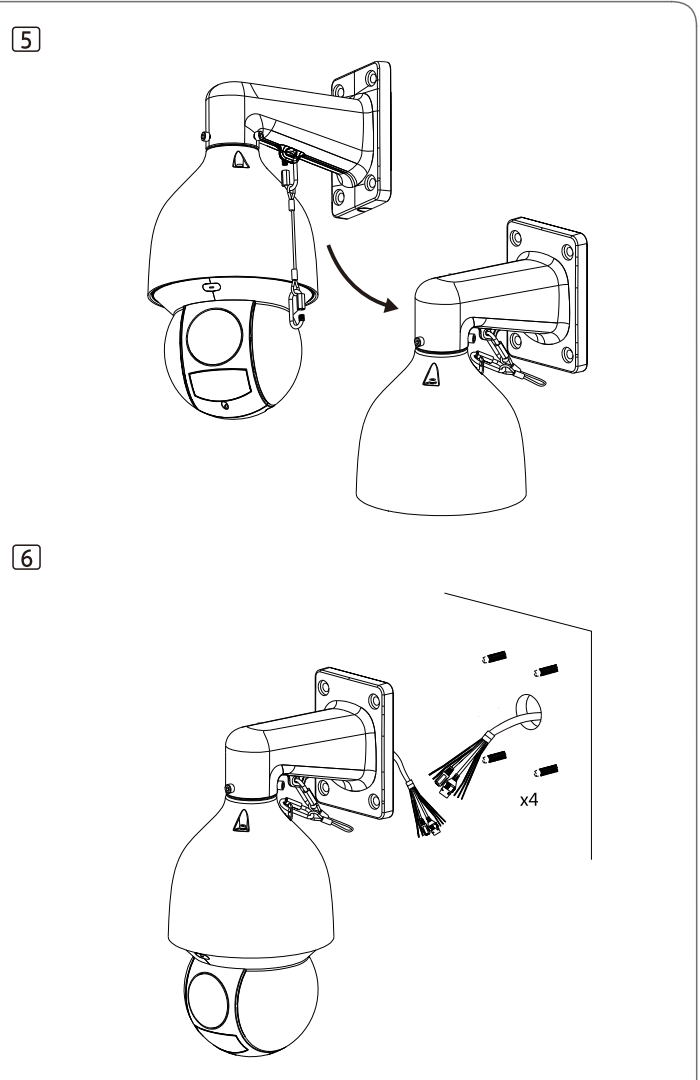
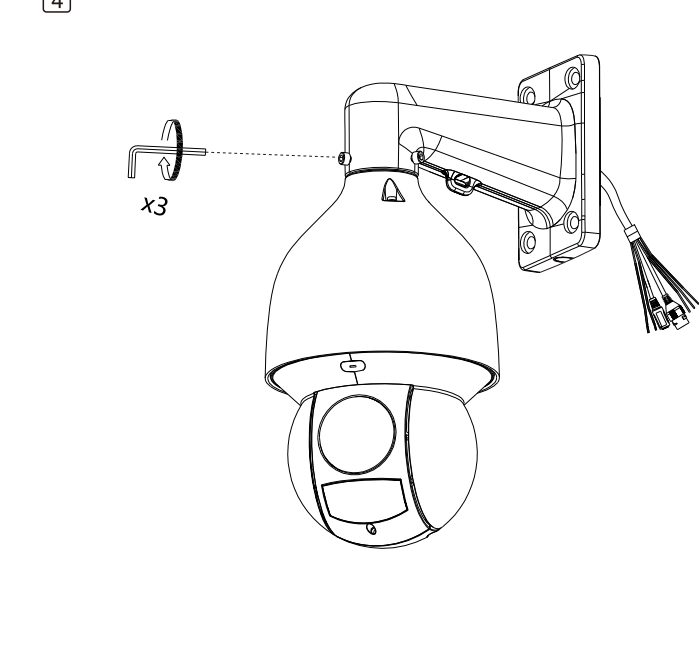
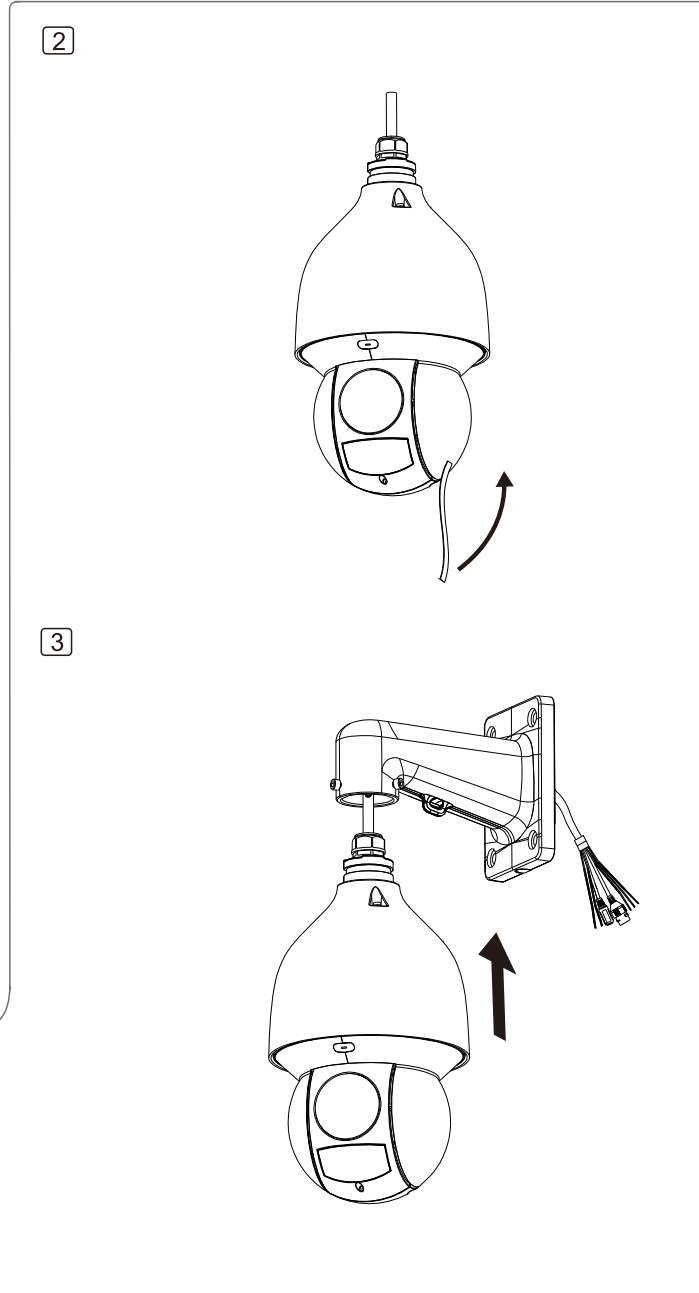
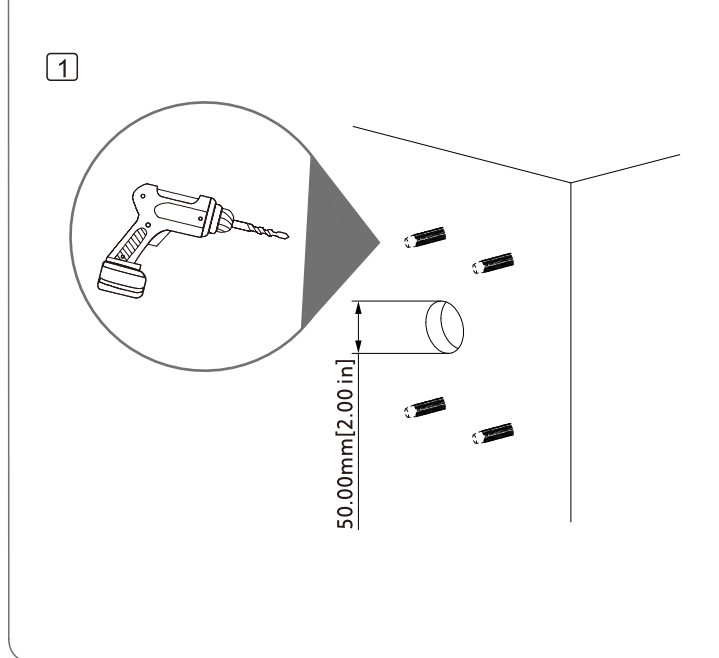
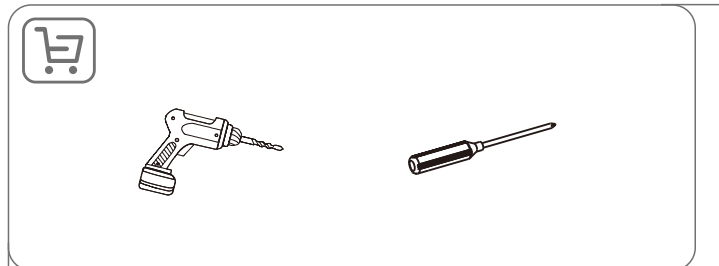
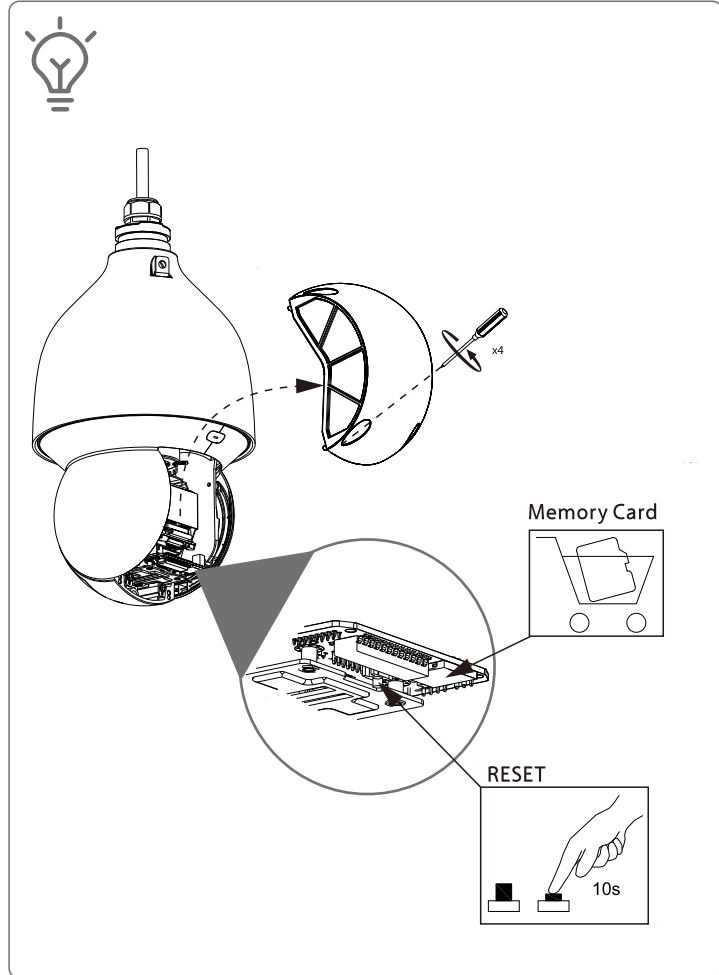
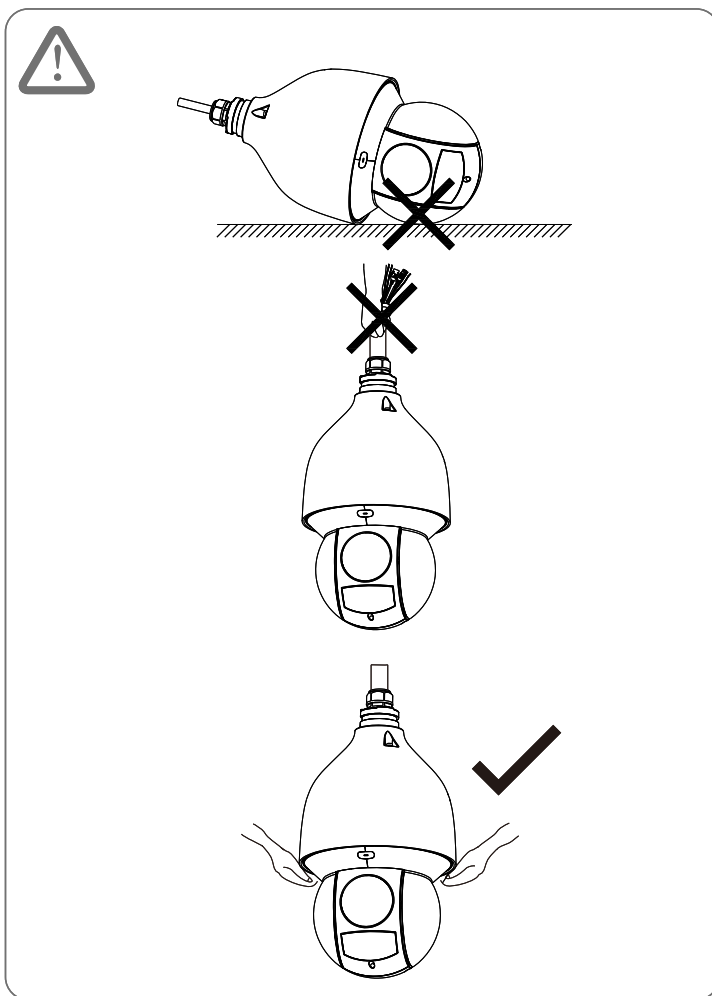
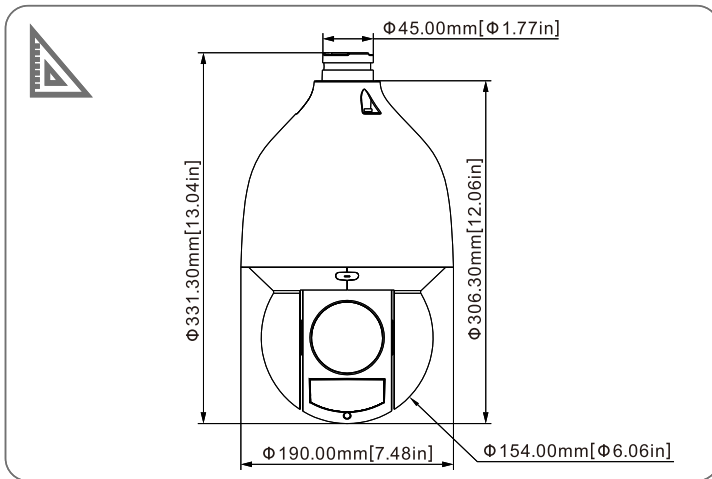
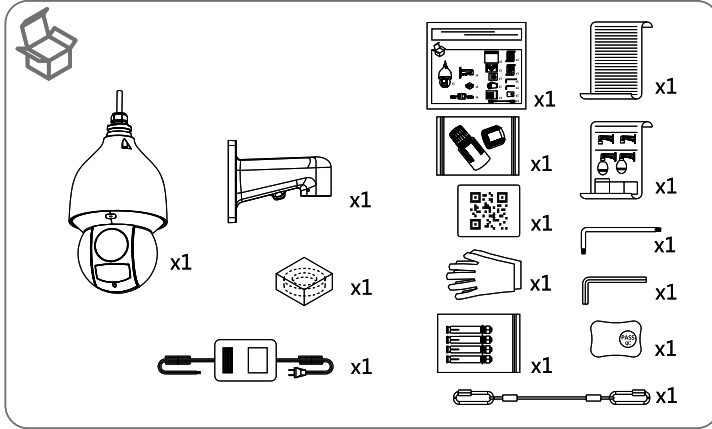
Due to the limited storage capacity of the equipment, the stored log is limited. If you need to save the log for a long time, it is recommended that you enable the network log function to ensure that the critical logs are synchronized to the network log server for tracing.

14. **Construct a Safe Network Environment**

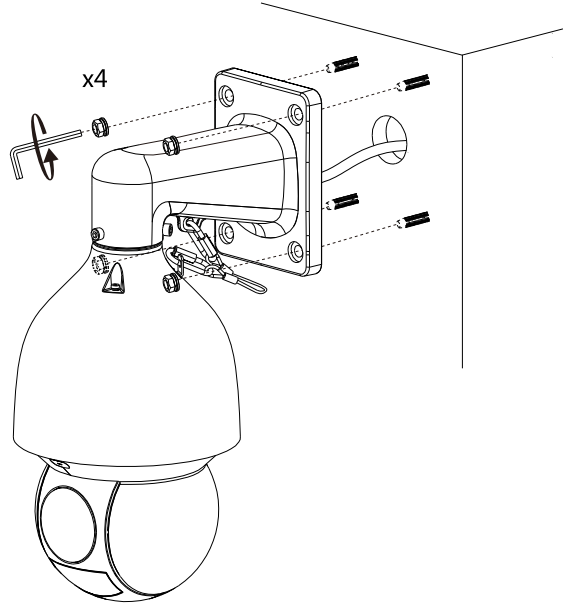
In order to better ensure the safety of equipment and reduce potential cyber risks, we recommend:

- Disable the port mapping function of the router to avoid direct access to the intranet devices from external network.
- The network should be partitioned and isolated according to the actual network needs. If there are no communication requirements between two sub networks, it is suggested to use VLAN, network GAP and other technologies to partition the network, so as to achieve the network isolation effect.
- Establish the 802.1x access authentication system to reduce the risk of unauthorized

access to private networks.



7



8

