

2.5

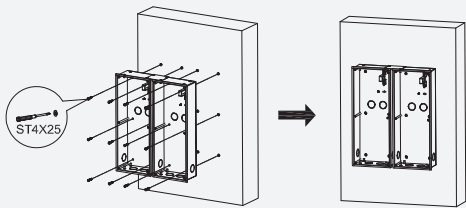

2.10

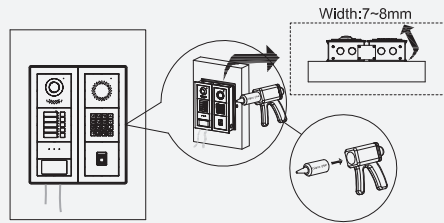

2.6

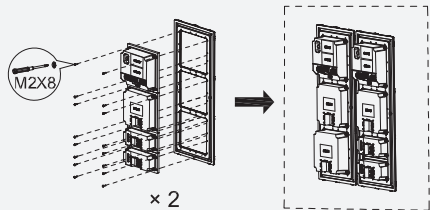

2.11

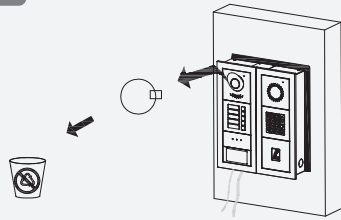

2.7

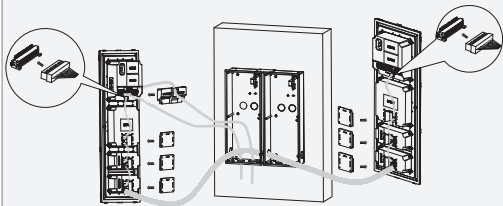



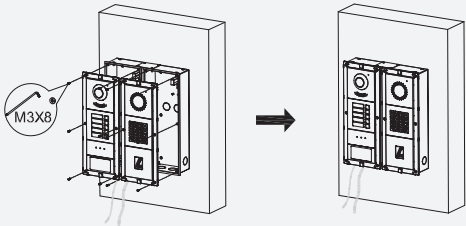



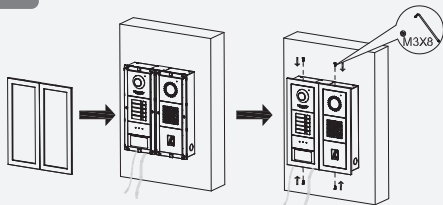



2.8



2.9





-  × 2  × 1
-  × 1  × 2
-  × 2  × 2
-  × 2  × 16
-  × 8  × 4
-  × 24

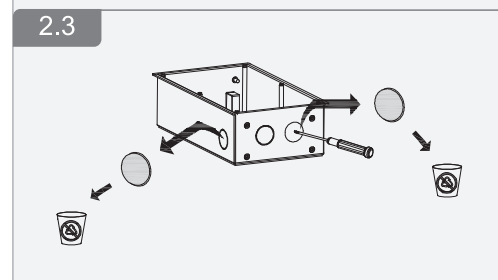
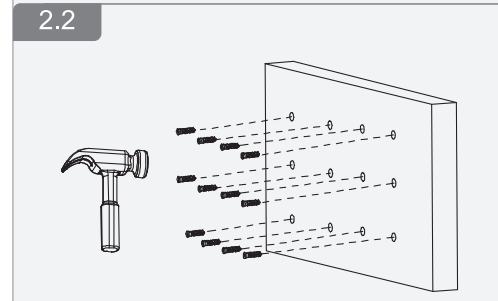
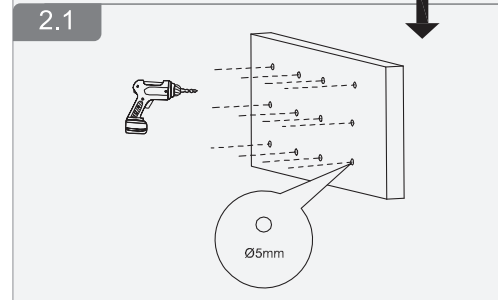
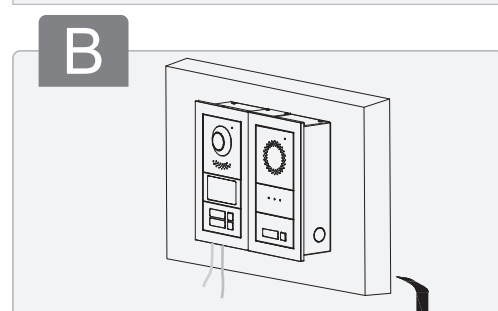
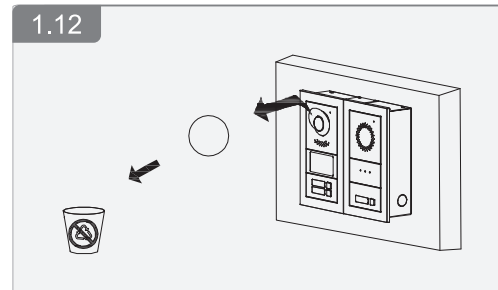
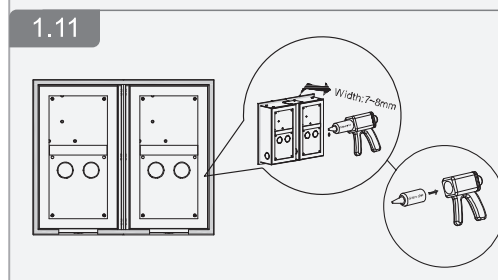
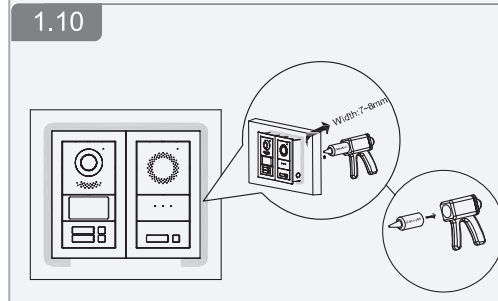
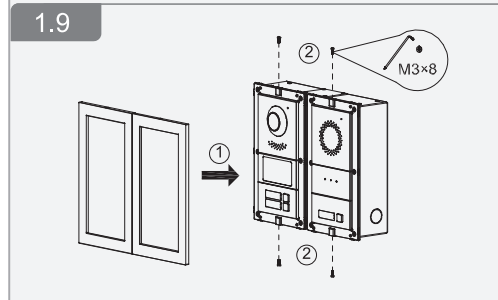
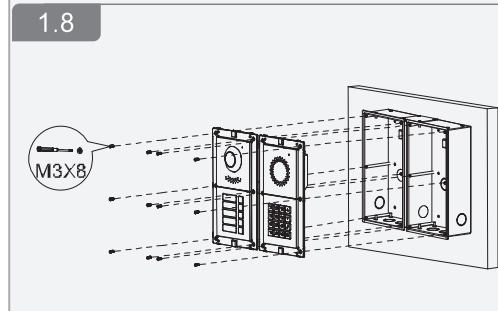
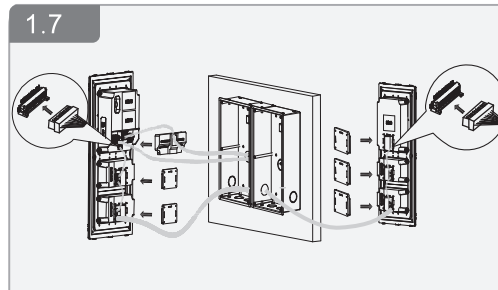
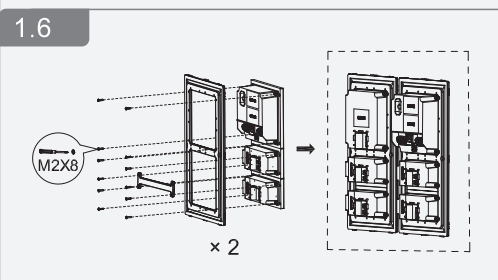
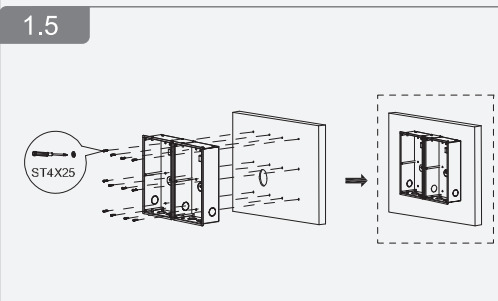
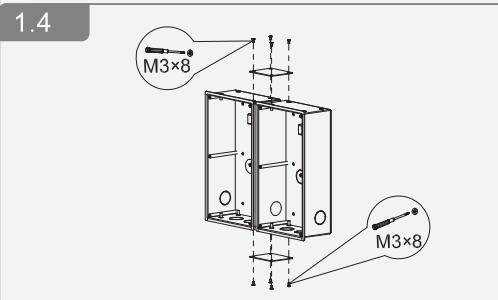
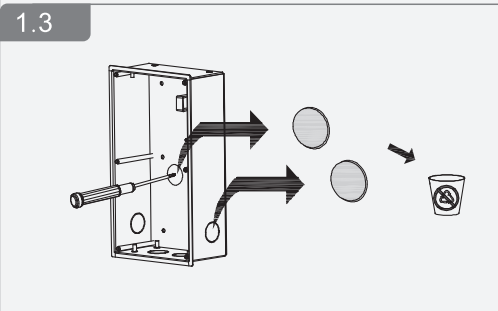
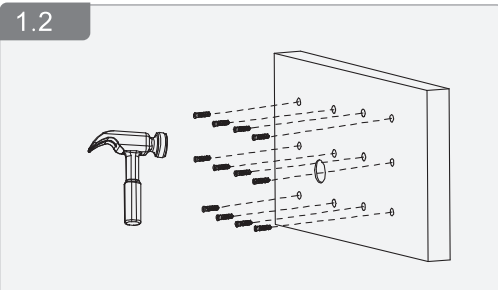

A

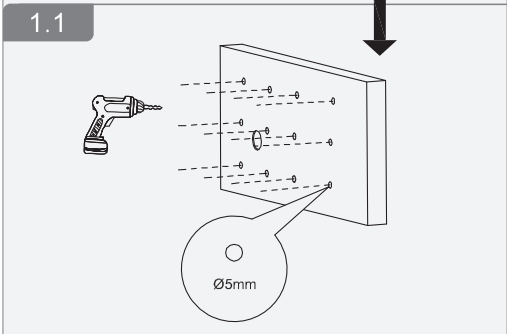
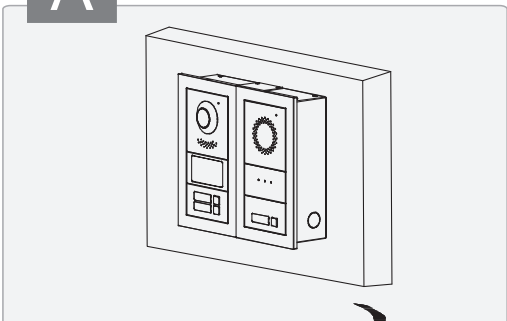

2.4

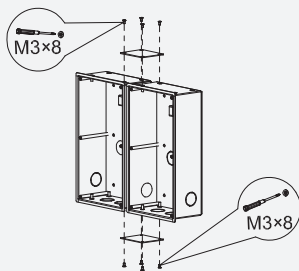

2.5

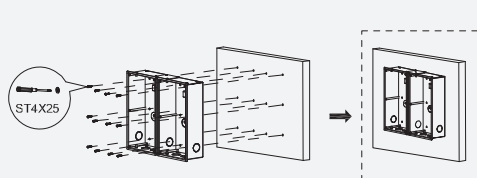

2.6

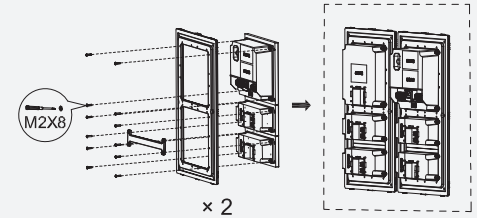

2.7

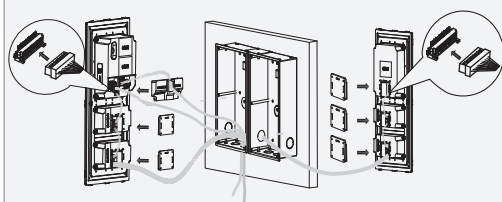

2.8

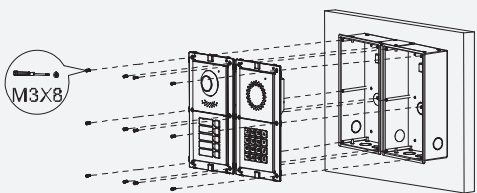

2.9

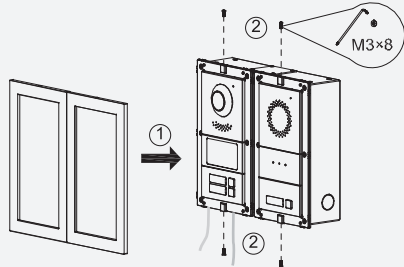

2.10

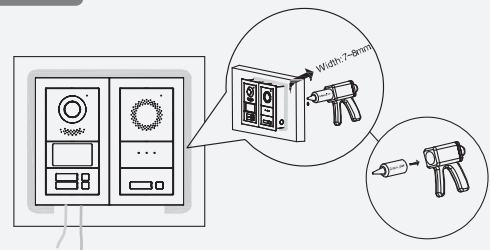

2.11

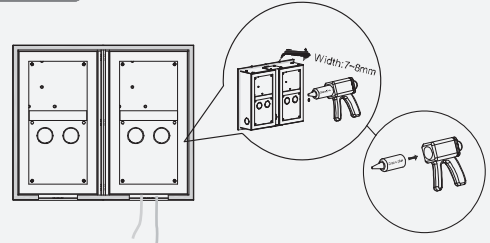

2.12

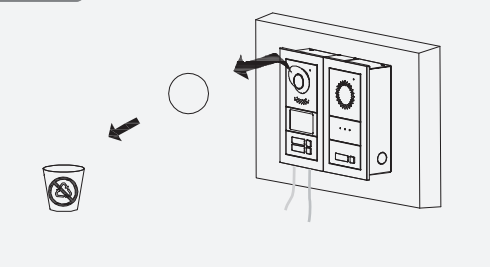

1.6

2.5

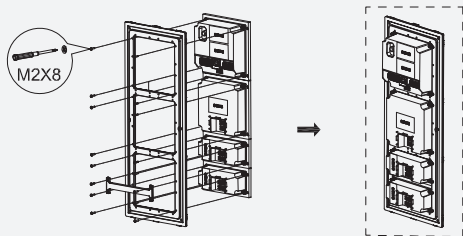

2.10

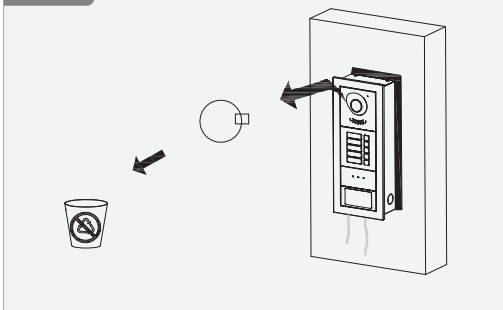

2.6

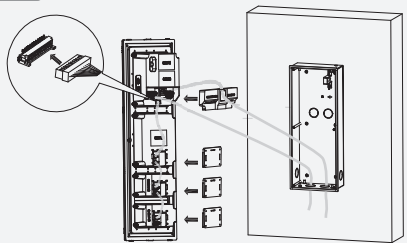

2.7

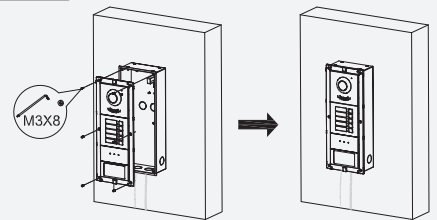

2.8

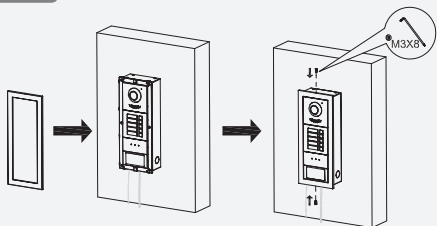

2.9

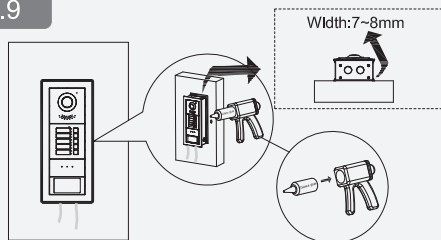

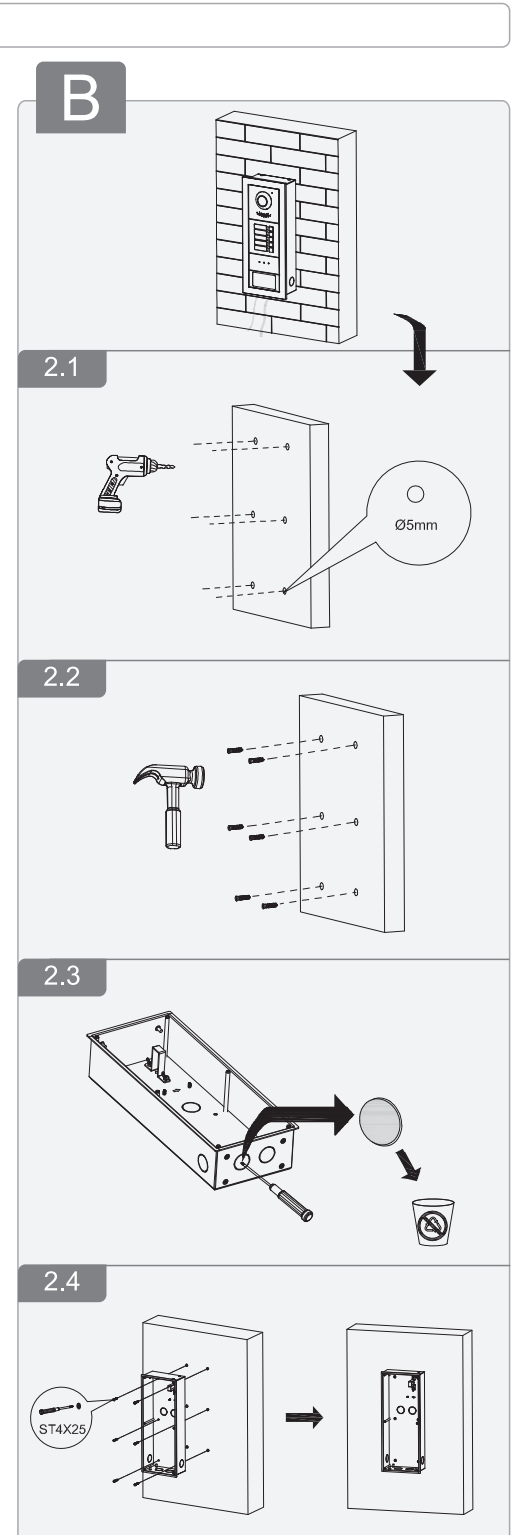
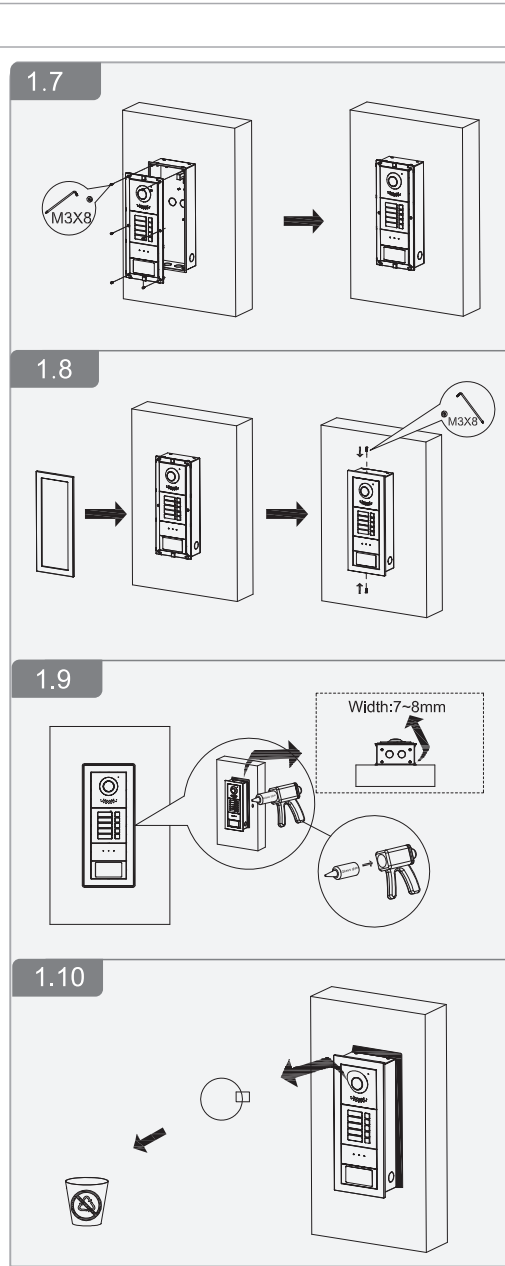
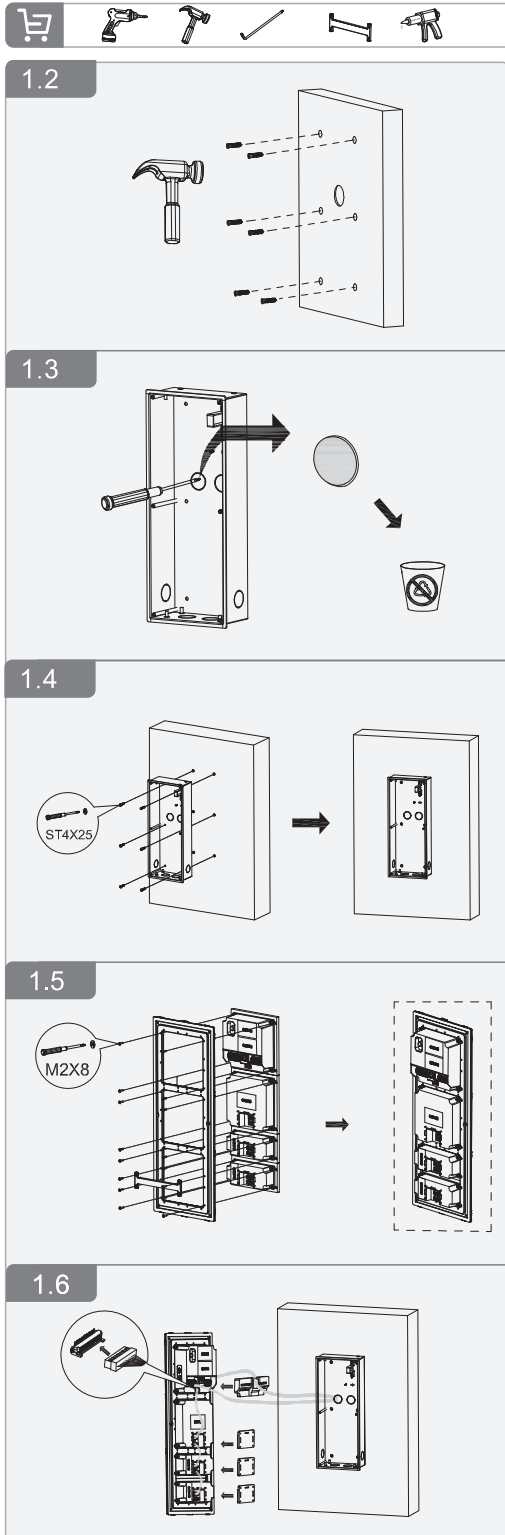
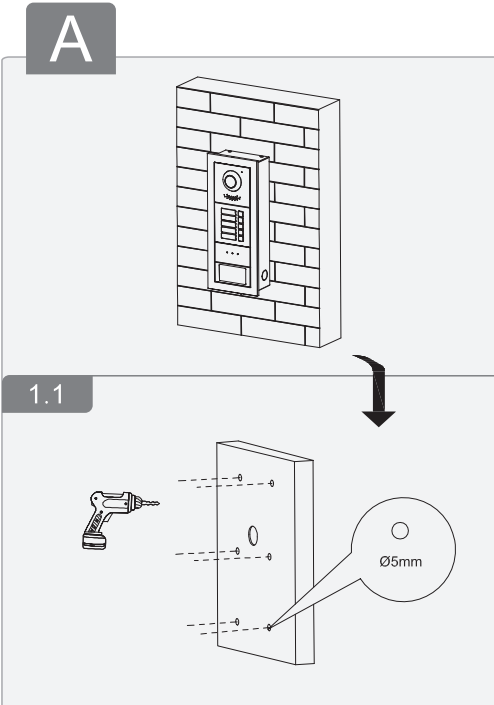
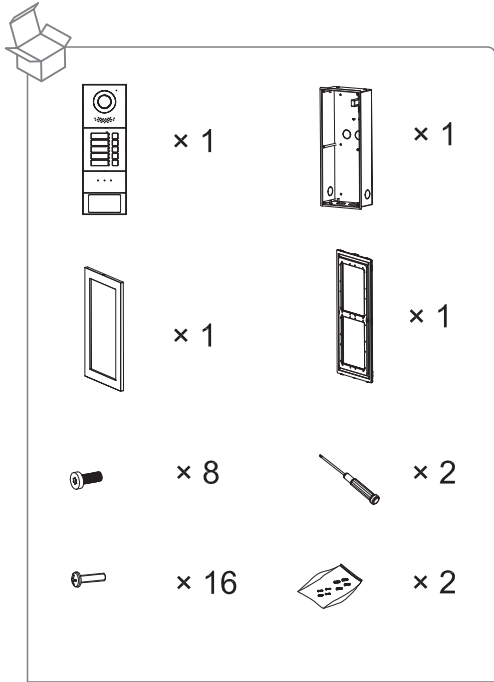

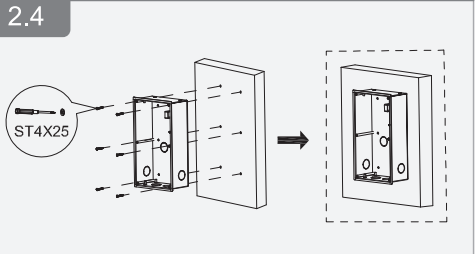
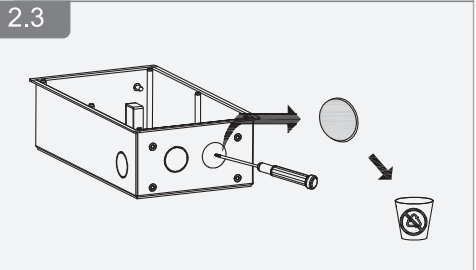
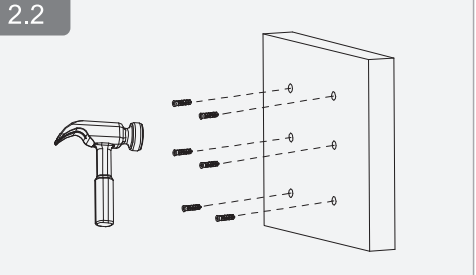
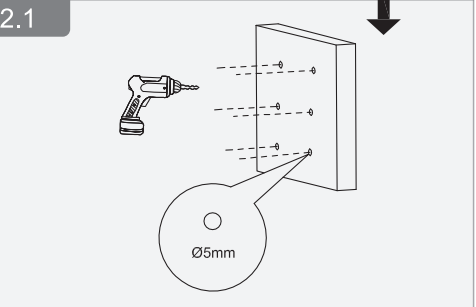
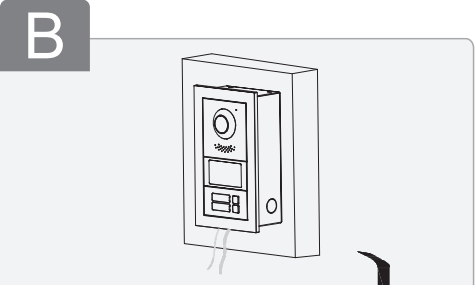
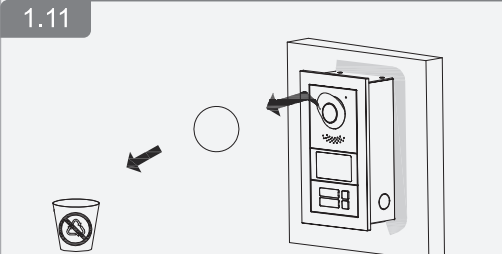
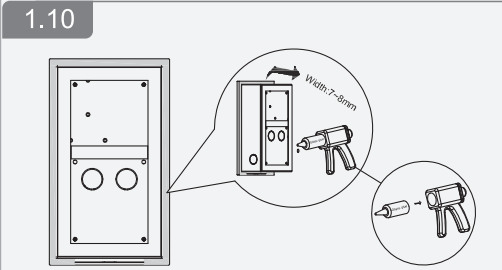
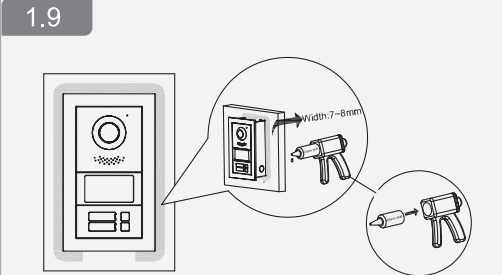
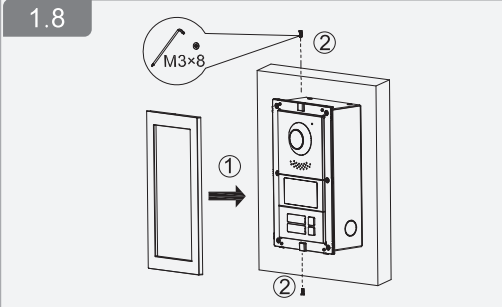
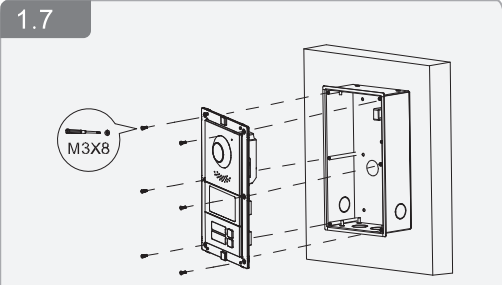
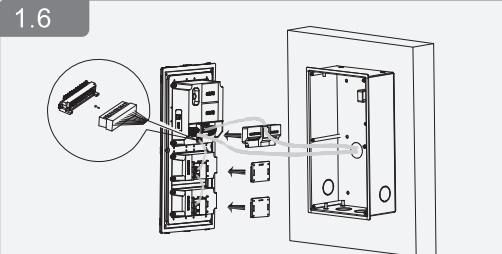
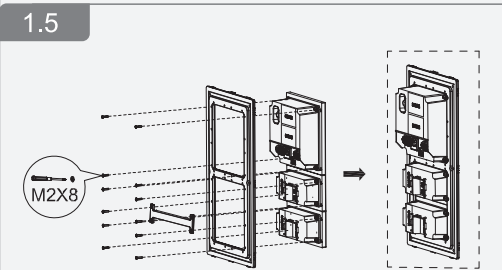
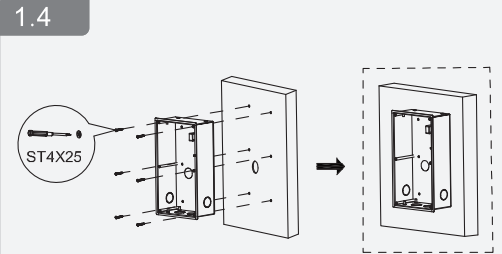
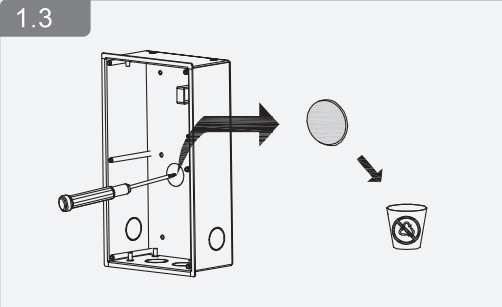
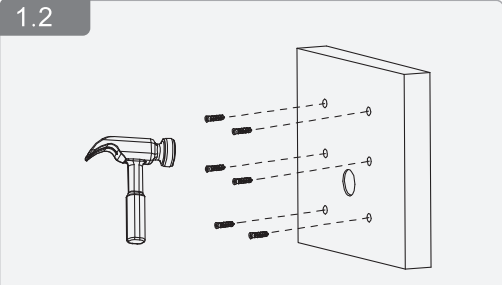
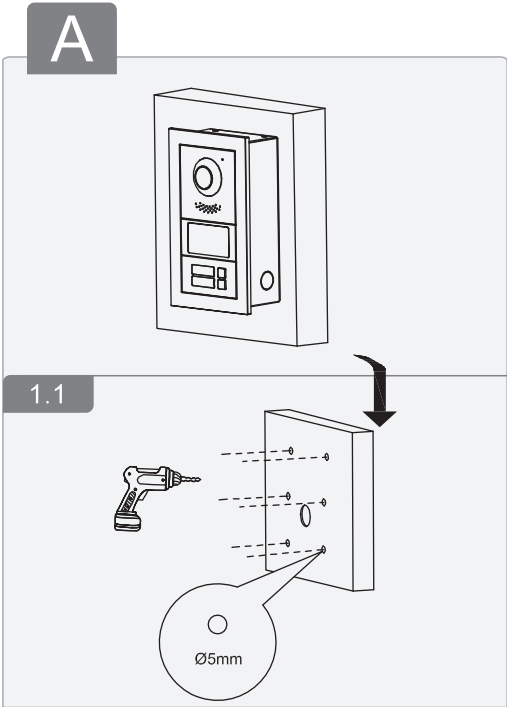
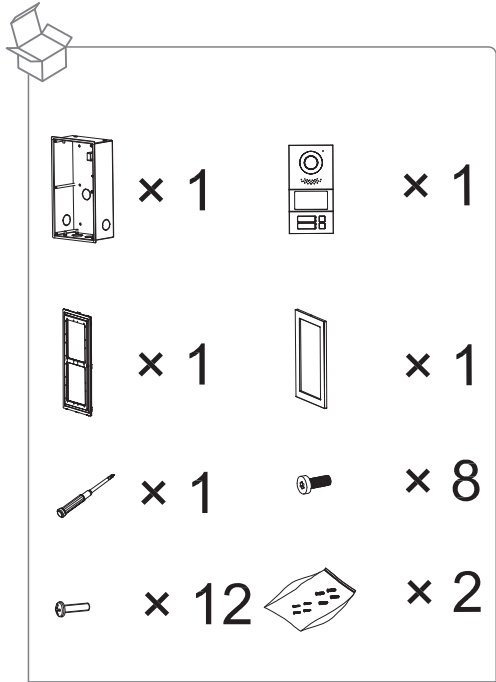

2.5

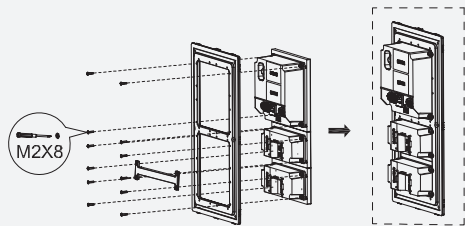

2.6

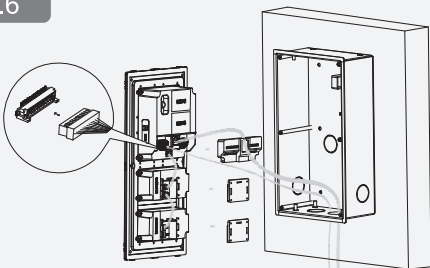

2.7

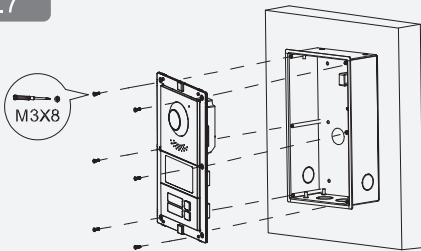

2.8

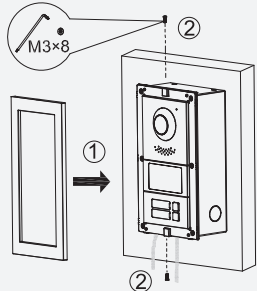

2.9

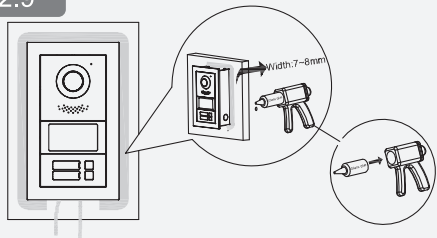

2.10

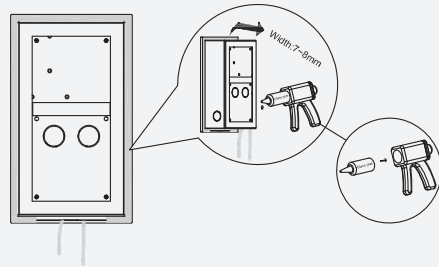

2.11

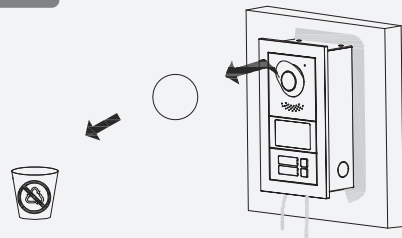

Modular Door Station

User's Manual





Foreword

General

This manual introduces how to configure the villa door station (hereinafter referred to as "VTO") on the web interface.

Safety Instructions

The following categorized signal words with defined meaning might appear in the Manual.

Signal Words	Meaning
 CAUTION	Indicates a potential risk which, if not avoided, could result in property damage, data loss, lower performance, or unpredictable result.
 NOTE	Provides additional information as the emphasis and supplement to the text.

Revision History

Version	Revision Content	Release Date
V1.0.0	First release.	January 2021

About the Manual

- The manual is for reference only. If there is inconsistency between the manual and the actual product, the actual product shall prevail.
- We are not liable for any loss caused by the operations that do not comply with the manual.
- The manual would be updated according to the latest laws and regulations of related jurisdictions. For detailed information, refer to the paper manual, CD-ROM, QR code or our official website. If there is inconsistency between paper manual and the electronic version, the electronic version shall prevail.
- All the designs and software are subject to change without prior written notice. The product updates might cause some differences between the actual product and the manual. Please contact the customer service for the latest program and supplementary documentation.
- There still might be deviation in technical data, functions and operations description, or errors in print. If there is any doubt or dispute, we reserve the right of final explanation.
- Upgrade the reader software or try other mainstream reader software if the manual (in PDF format) cannot be opened.
- All trademarks, registered trademarks and the company names in the manual are the properties of their respective owners.
- Please visit our website, contact the supplier or customer service if there is any problem occurring when using the device.
- If there is any uncertainty or controversy, we reserve the right of final explanation.

Important Safeguards and Warnings

The following description is the correct application method of the VTO. Read the manual carefully before use, to prevent danger and property loss. Strictly conform to the manual during use and keep it properly after reading.

Operating Requirements

- Do not expose the device to direct sunlight or heat source.
- Do not install the device in a humid or dusty environment.
- Horizontally install the device at stable places to prevent it from falling.
- Do not drip or splash liquids onto the device, or put on the device anything filled with liquids.
- Install the device at well-ventilated places and do not block its ventilation opening.
- Use the device only within rated input and output range.
- Do not dismantle the device by yourself.
- Transport, use and store the device within allowed humidity and temperature range.

Power Requirements

- Use electric wires recommended in your area, and within its rated specification.
- Use power supply that meets SELV (safety extra low voltage) requirements, and supply power with rated voltage that conforms to Limited Power Source in IEC60950-1. For specific power supply requirements, see the label on the device.
- Appliance coupler is a disconnecting device. During normal use, keep an angle that facilitates operation.

Table of Contents

Foreword	I
Important Safeguards and Warnings	II
1 Initializing the VTO	1
2 Login and Resetting Password	2
2.1 Login	2
2.2 Resetting Password	2
3 Main Interface	4
4 Local Settings	5
4.1 Basic	5
4.2 Video & Audio	6
4.3 Access Control Settings	8
4.3.1 Local.....	8
4.3.2 RS-485	9
4.3.3 Password Management.....	9
4.4 System	9
4.5 Security	11
4.6 Wiegand.....	12
4.7 Onvif User.....	13
4.8 Upload File.....	13
5 Household Setting	15
5.1 VTO No. Management	15
5.2 VTH Management.....	16
5.2.1 Adding Room Number.....	16
5.2.2 Issuing Access Card	19
5.2.3 Issuing Fingerprint	20
5.3 VTS Management.....	21
5.4 IPC Setting	22
5.5 Status	23
5.6 Publish Information.....	24
5.6.1 Send Info	24
5.6.2 History Info.....	24
6 Network	26
6.1 Basic	26
6.1.1 TCP/IP	26
6.1.2 Port.....	26
6.1.3 P2P	27
6.2 UPnP.....	27
6.2.1 Enabling UPnP Services.....	27
6.2.2 Adding UPnP Services.....	28
6.3 SIP Server	28
6.4 Firewall	29
7 Log Management	30
Appendix 1 Cybersecurity Recommendations	31

1 Initializing the VTO

For first-time login or after resetting the VTO, you need to initialize it on the web interface.

Step 1 Power on the VTO.

Step 2 Enter the default IP address (192.168.1.108) of the VTO in the browser address bar.



Make sure that the IP address of your PC is in the same network segment as the VTO.

Figure 1-1 Device initialization

Device Init [Close]

1 One — 2 Two — 3 Three

Username admin

Password

Low Middle High

Confirm Password

Next

Step 3 Enter and confirm the password, and then click **Next**.

Step 4 Enter an email address for resetting password.

Step 5 Click **Next**, and then click **OK**.

2 Login and Resetting Password

2.1 Login

Before login, make sure that the PC is in the same network segment as the VTO.

Step 1 Go to the IP address of the VTO in the browser.



For first-time login, enter the default IP. If you have multiple VTOs, we recommend changing the default IP address (**Network > Basic**) to avoid conflict.

Step 2 Enter "admin" as username and the password you set during initialization, and then click **Login**.

Figure 2-1 Login interface

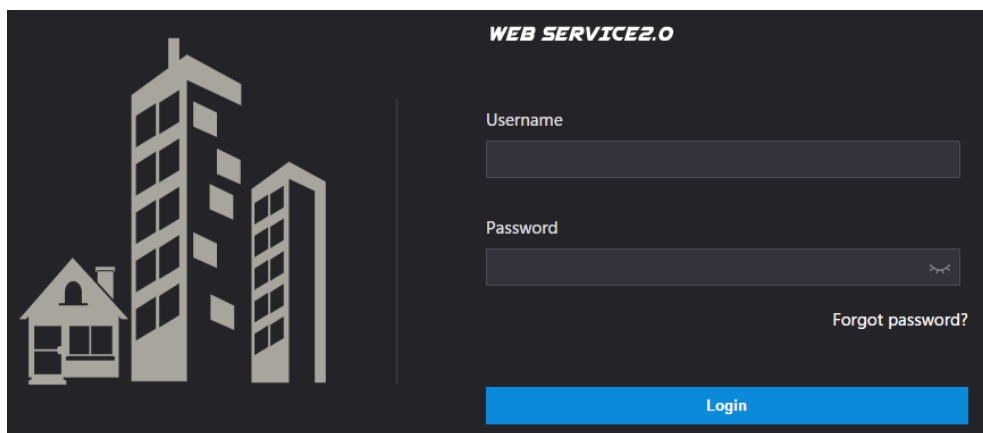

2.2 Resetting Password

Step 1 On the login interface, click **Forgot Password?**, and then click **Next**.

Figure 2-2 Reset the password (2/3)

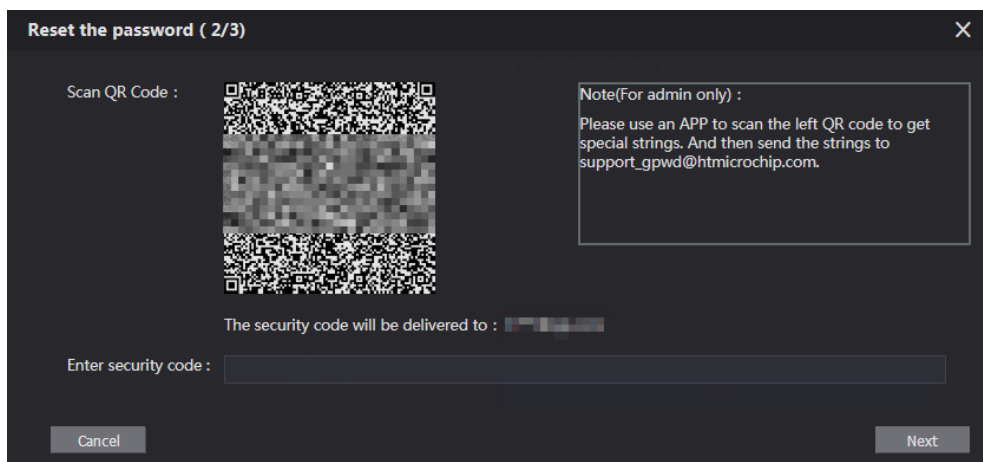

Step 2 Scan the QR code, and then you will get a string of numbers and letters.

Step 3 Send the string to the email: support_gpwd@htmicrochip.com, and then the security code will be sent to the email address configured during initialization.

Step 4 Enter the security code in the input box, and then click **Next**.



- If you did not set an email address during initialization, contact your supplier or customer service for help.
- The security code will be valid only for 24 hours upon receipt.
- If you enter the wrong security code for 5 consecutive times, your account will be locked for 5 minutes.

Step 5 Enter and confirm the new password, and then click **OK**.

3 Main Interface

Figure 3-1 Main interface

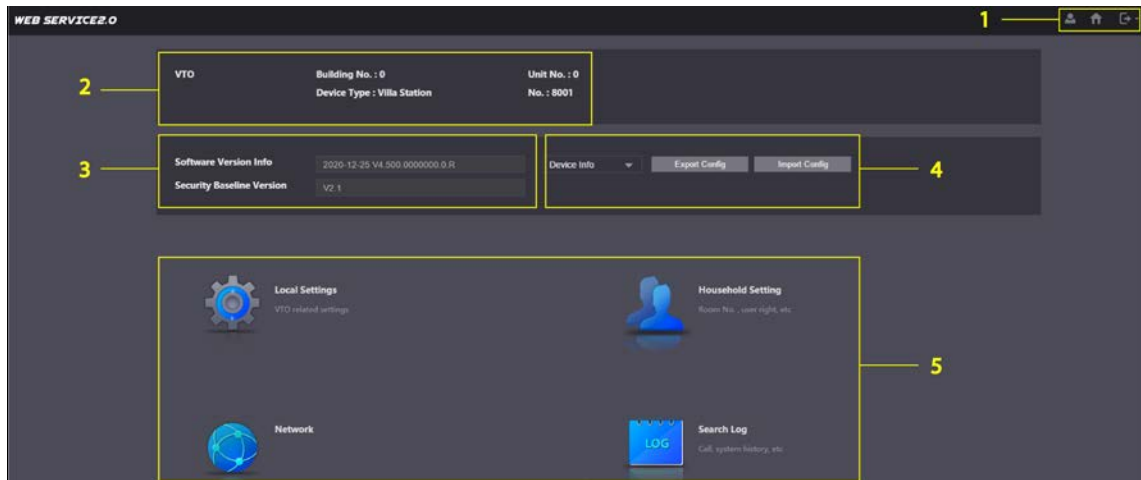

Table 3-1 Main interface introduction

No.	Function	Description
1	General function	<ul style="list-style-type: none"> : Change the password and your email address. : Go to the main interface. : Log out, restart the VTO or restore the VTO to factory settings. <p></p> <p>If you restore the VTO to factory settings, all data except external storage will be deleted. You can format the SD card to delete the data in it.</p>
2	VTO information	View the information of the VTO and the system.
3	System information	
4	Configuration manager	Export or import VTO configuration or user information.
5	Function	<p>Configure parameters for different functions.</p> <p></p> <p>Interface and function might vary with the device type you configured for the VTO. The actual interface and function shall prevail.</p>

4 Local Settings

This chapter introduces the detailed configuration of the VTO.

4.1 Basic

Step 1 Select **Local Settings > Basic**.

Figure 4-1 Basic

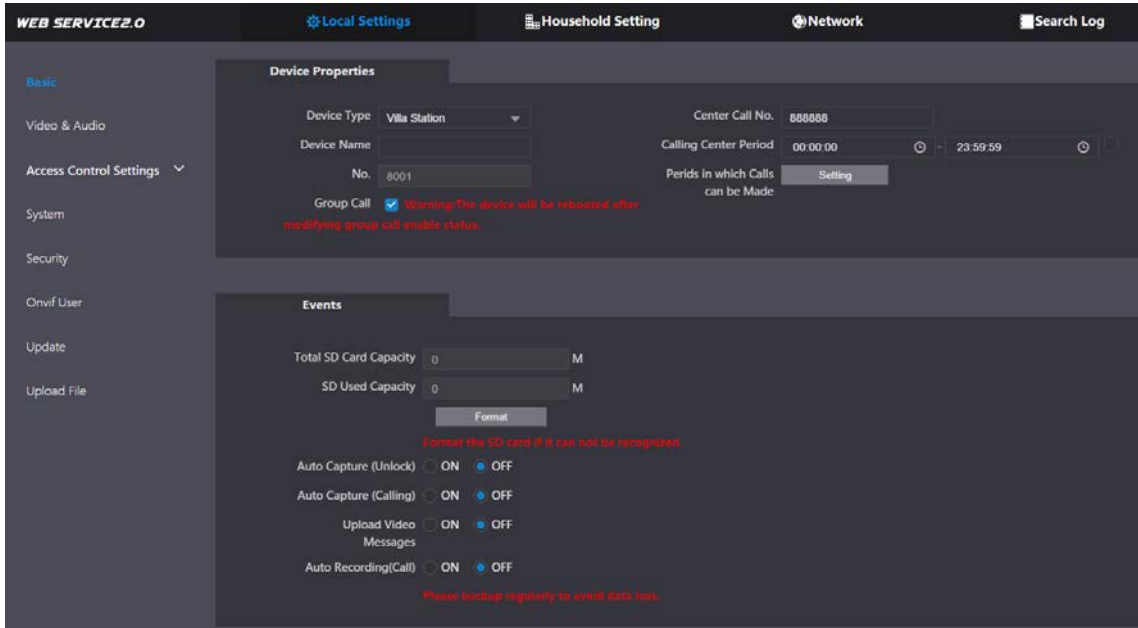

Step 2 Configure the parameters.

Table 4-1 Basic parameter description

Parameter	Description
Device Type	Select Villa Station or Small Apartment as needed.
Center Call No.	The default phone number for the management center is 888888, and you can set it to any number with up to 9 digits.
Device Name	When other devices are monitoring this VTO, the device name will appear on the monitoring image.
Calling Center Period	Time period in which the management center can be called.
No.	Used to differentiate each VTO, and we recommend setting it according to unit or building number, and then you can add VTOs to the SIP server by using their numbers.  You can change the number of the VTO when it is not working as the SIP server.
Periods in which Calls can be Made	Configure the time if you only want to receive calls during a specific period.
Group Call	Enable it on the VTO that works as the SIP server, and when a main VTH receives a call, all extension VTHs will also receive the call.

Parameter	Description
Total SD Card Capacity	Displays the total and used capacity of the SD card. You can click Format to delete all the data in the SD card.
SD Used Capacity	
Format	
Auto Capture (Unlock)	When the door is unlocked, the VTO will take two snapshots and save them to the SD card.
Auto Capture (Calling)	Take a snapshot and save it in the SD card of the VTO when the VTO is calling.
Upload Video Messages	When enabled: <ul style="list-style-type: none"> ● If an SD card is inserted in both the VTH and VTO, the video message will be saved both in the SD cards of the VTH and the VTO. ● If an SD card is only inserted in the VTH or the VTO, the video message will be saved only in the SD card of the VTH or the VTO. ● If no SD card is inserted in the VTH or VTO, no video message will be saved.
Auto Recording (Call)	Record video when the VTO is in a call, and save the recording in the SD card of the VTO.

Step 3 Click **Save**.

4.2 Video & Audio

Configure the video format and quality, and audio of the VTO.

Step 1 Select **Local Settings > Video & Audio**.

Figure 4-2 Video and audio

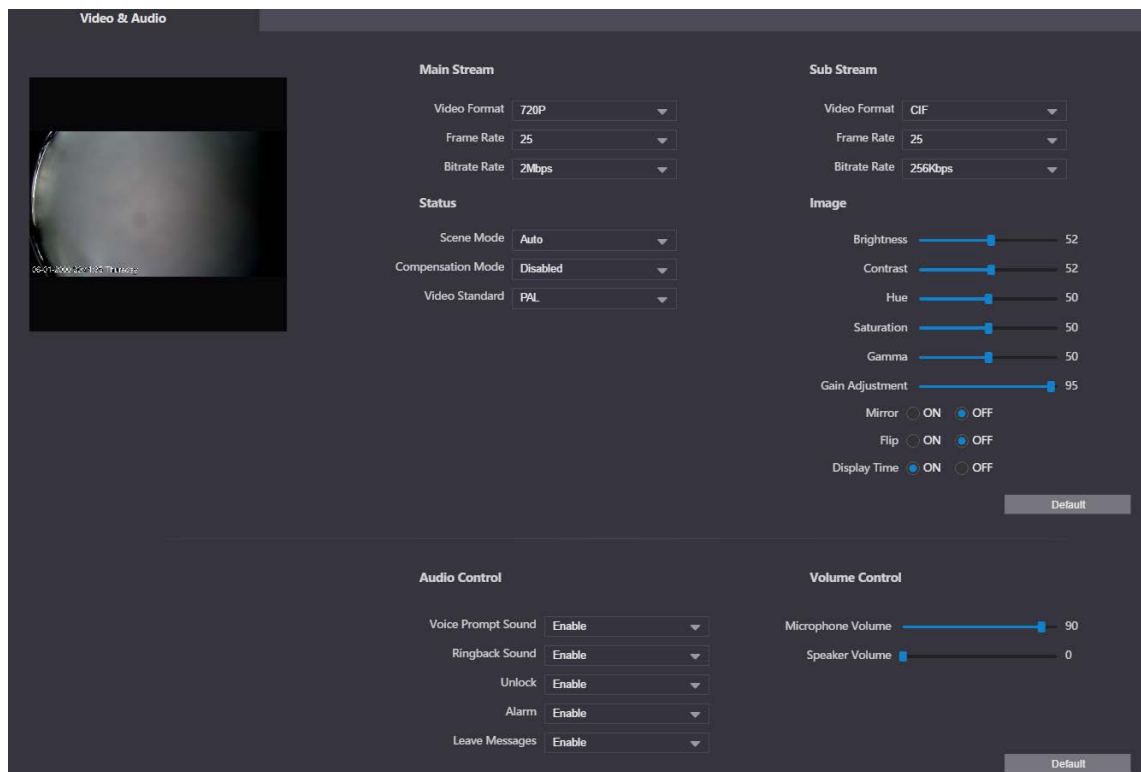

Step 2 Configure the parameters, which will take effect upon change.

Table 4-2 Video parameter description

Parameter		Description
Main/Sub Stream	Video Format	Select different resolution as needed: <ul style="list-style-type: none"> ● 1080P: 1920 × 1080. ● 720P: 1280 × 720. ● WVGA: 800 × 480. ● QVGA: 320 × 240. ● D1: 720 × 480. ● CIF: 352 × 288.
	Frame Rate	The larger the value, the smoother the video, but it requires more bandwidth.
	Bitrate Rate	The larger the value, the better the video quality, but it requires more bandwidth.
Status	Scene Mode	Select as needed according to the lighting condition. Auto is selected by default.
	Compensation Mode	<ul style="list-style-type: none"> ● BLC: Back light compensation. Improve the clarity of the target in the image. ● WDR: Wide dynamic range. Enhance the brightness of dark areas, and reduce the brightness of bright areas to improve the image. ● HLC: High light compensation. Reduce the brightness of the strong spots to improve the overall image.
	Video Standard	Select PAL or NTSC according to your area.  PAL is mostly used in China and Europe, and NTSC primarily in the United States and Japan.
Image	Brightness	The larger the value, the brighter the image.
	Contrast	Larger value for more contrast between bright and dark areas.
	Hue	Make the color brighter or darker. The default value is made by the light sensor, and we recommend keeping it default.
	Saturation	The brighter the value, the thicker the color.
	Gamma	Changes the picture brightness and improves the picture dynamic range in a non-linear way. The larger the value, the brighter the image.
	Gain Adjustment	Amplify the video signal to increase image brightness. If the value is too large, there will be more noise in the image.
	Mirror	Displays the image with left and right side reversed.
	Flip	Displays the image upside down.
Display Time	Displays the current time and date on the video image.	
Audio Control	—	Turn on or off each type of sound.
Volume Control	Microphone Volume	Adjust the volume as needed.
	Speaker Volume	

4.3 Access Control Settings

This section introduces how to configure the two locks connected to the lock port or the RS-485 port of the VTO.

4.3.1 Local

Step 1 Select **Local Settings > Access Control Settings**.

Figure 4-3 Local

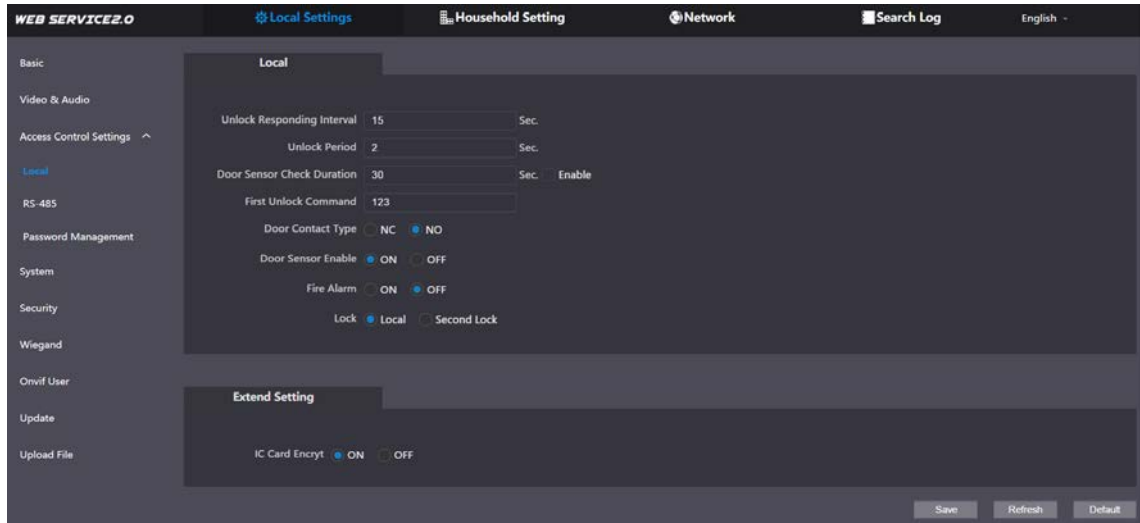

Step 2 Configure the parameters.

Table 4-3 Local access control parameter description

Parameter	Description
Unlock Responding Interval	The door can only be unlocked again after the interval.
Unlock Period	The time during which the lock stays unlocked.
Door Sensor Check Duration	<ul style="list-style-type: none"> Enable it, and the door will not be locked until the door sensors contact each other. If the door is unlocked longer than the Door Sensor Check Duration, the door sensor alarm will be triggered, and the alarm will be sent to the management center. Disable it, and then the door will be locked after the Unlock Period.  <p>You need to install a door contact to configure this parameter.</p>
First/Second Unlock Command	You can connect a third-party phone, such as a SIP phone, to the VTO, and use the command to open the door remotely.
Door Contact Type	<ul style="list-style-type: none"> NC: Normally closed. NO: Normally open.
Door Sensor Enable	Synchronize door sensor status to indoor monitors (VTHs).
Fire Alarm	If turned on, you can connect an alarm device to the port that is originally for the door contact, but you cannot use the door contact function.
Lock	Non-remote methods, such as password or card, will unlock the lock you select.
IC Card Encrypt	Access cards issued by the VTO will be encrypted and unclonable.

Step 3 Click **Save**.

4.3.2 RS-485

Select **Local Settings > Access Control Settings**, and then configure the parameters of the lock connected through the RS-485 port. See Table 4-3 for parameter description.

Figure 4-4 Lock connected through the RS-485 port

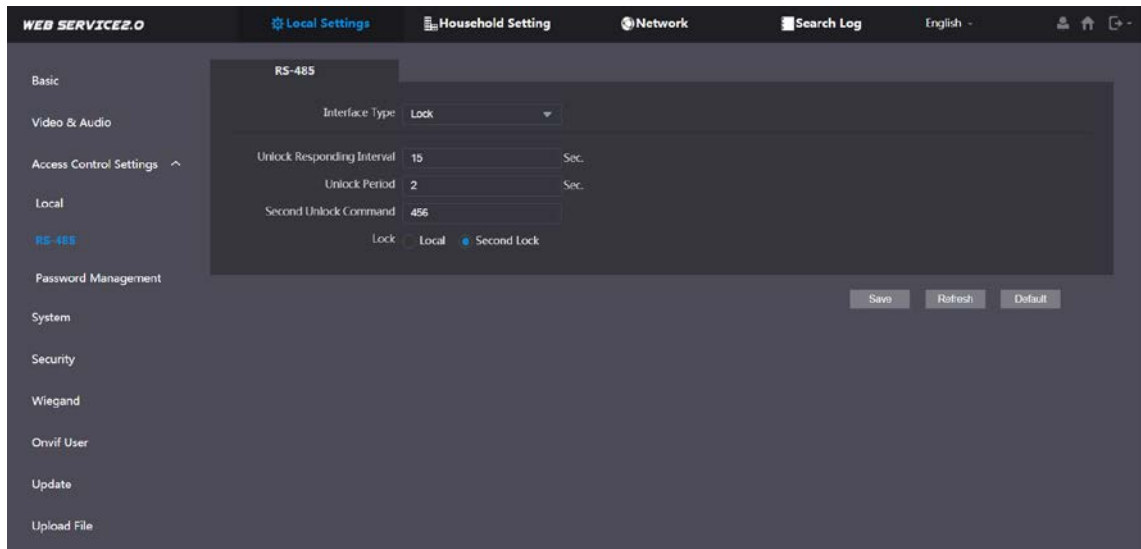

4.3.3 Password Management

Add a username and password used to unlock the door.

Figure 4-5 Password management

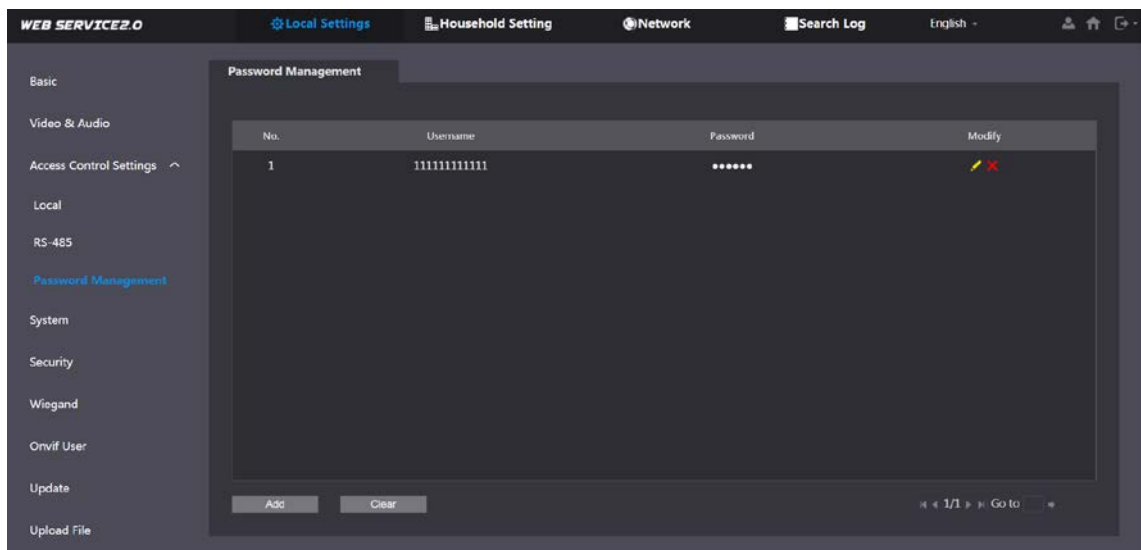

4.4 System

Configure time parameters, NTP server, and more.

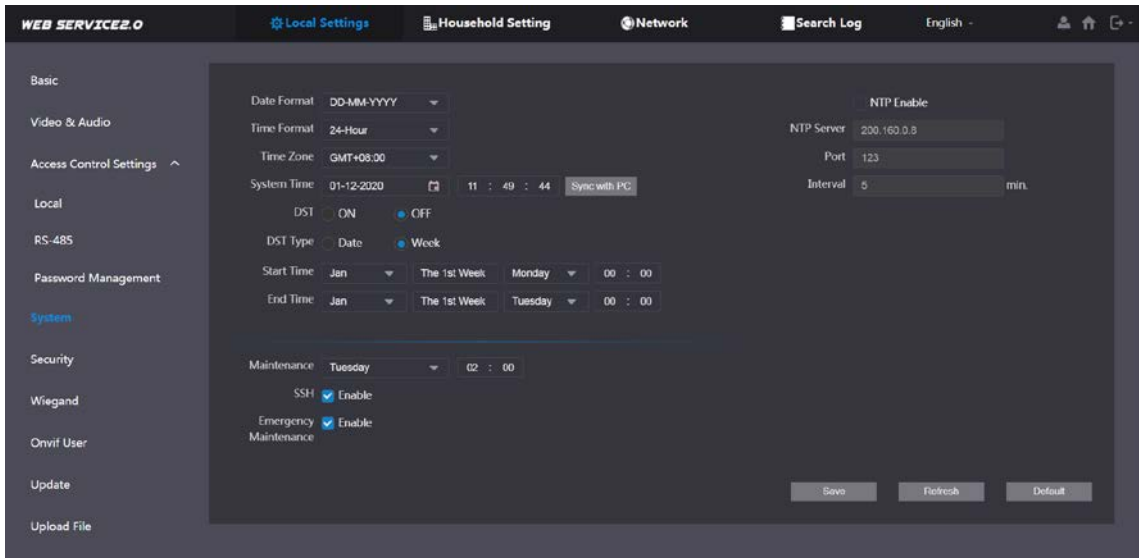

Step 1 Select **Local Settings > System**.

Figure 4-6 System



Step 2 Configure the parameters.

Table 4-4 System parameter description

Parameter	Description
Date Format	Select a format as needed.
Time Format	
System Time	 <p>Changing system time might cause problems on video searching and information publication. Turn off video recording and auto snapshot before changing it.</p>
Time Zone	Configure the time zone as needed.
Sync with PC	Synchronize the VTO system time with your PC.
DST	Daylight saving time. If it is applicable to your area, you need to enable it, and then configure DST type, start time and end time.
DST Type	Select Date or Week as needed, and then configure the specific period.
Start Time	Configure the start time and end time of DST.
End Time	
NTP Enable	Enable NTP and enter the IP address of the NTP server, and then the VTO will synchronize time with the NTP server automatically.
NTP Server	
Port	NTP server port number.
Interval	VTO time update cycle. 30 minutes at most.
Maintenance	Define the time when the VTO will restart automatically.
SSH	 <p>You can connect debugging devices to the VTO through SSH protocol.</p> <p>We recommend turning it off, and turn on security mode and outbound service information protection. See "4.5 Security". Otherwise, the VTO might be exposed to security risks and data leakage.</p>
Emergency Maintenance	 <p>Enable it for fault analysis and repair.</p> <p>This function will occupy 8088 and 8087 ports.</p>

Step 3 Click **Save**.

4.5 Security

Configure functions that involve device security.



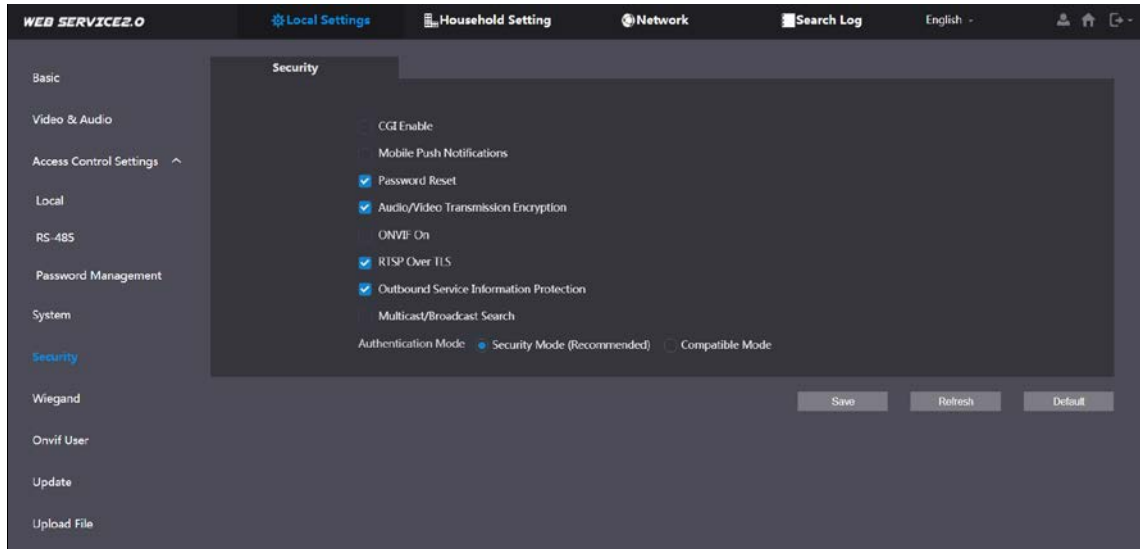

Step 1 Select **Local Settings > Security**.





Figure 4-7 Security



Step 2 Configure the parameters.

Table 4-5 Security parameter description

Parameter	Description
CGI Enable	<p>Enable the use of CGI command.</p> <p></p> <p>We recommend turning it off. Otherwise, the VTO might be exposed to security risks and data leakage.</p>
Mobile Push Notification	<p>Send information to the app on the smartphone.</p> <p></p> <p>We recommend turning it off if you do not need this function. Otherwise, the VTO might be exposed to security risks and data leakage.</p>
Password Reset	<p>If turned off, you will not be able to reset password.</p>
Audio/Video Transmission Encryption	<p>Encrypt all data during voice or video call.</p> <p></p> <p>We recommend turning it on. Otherwise, the VTO might be exposed to security risks and data leakage.</p>
ONVIF On	<p>Allow third-party devices to pull video stream of the VTO through the ONVIF protocol.</p> <p></p>

Parameter	Description
	We recommend turning it off. Otherwise, the VTO might be exposed to security risks and data leakage.
RTSP Over TSL	Output encrypted bit stream through RTSP.  We recommend turning it on. Otherwise, the VTO might be exposed to security risks and data leakage.
Outbound Service Information Protection	Protect your passwords.  We recommend turning it on. Otherwise, the VTO might be exposed to security risks and data leakage.
Multicast/Broadcast Search	Enable it and the VTO will be found by other devices.  We recommend turning it off. Otherwise, the VTO might be exposed to security risks and data leakage.
Authentication Mode	<ul style="list-style-type: none"> ● Security Mode (recommended): Supports logging in with Digest authentication. ● Compatible Mode: Use the old login method.  We recommend the security mode. Compatible mode might expose the VTO to security risks and data leakage.

Step 3 Click **Save**.

4.6 Wiegand

Configure the parameters as needed when connected to other devices, such as a card reader with a Wiegand port.

Figure 4-8 Wiegand

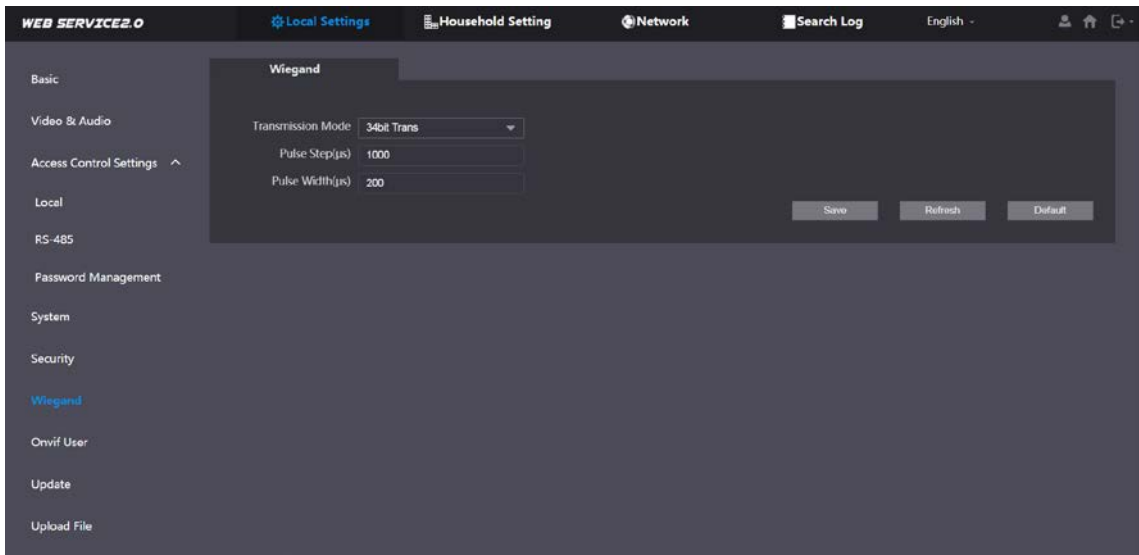

4.7 Onvif User

Add accounts for devices to monitor the VTO through the ONVIF protocol.



If you delete an account, it cannot be undone.

Step 1 Select **Local Settings > Onvif User**.

Step 2 Click **Add**.

Figure 4-9 Add an ONVIF user

Step 3 Enter the information, and then click **Save**.

ONVIF devices can now monitor the VTO by using the account. See the user's manual of the ONVIF device for details.

4.8 Upload File

Upload audio file to change the sound when calling, unlocking the door, and more.

Step 1 Select **Local Settings > Upload File**.

Step 2 Select an audio type, and then click **Browse** to select the audio file as needed.

Figure 4-10 Change the sound prompt

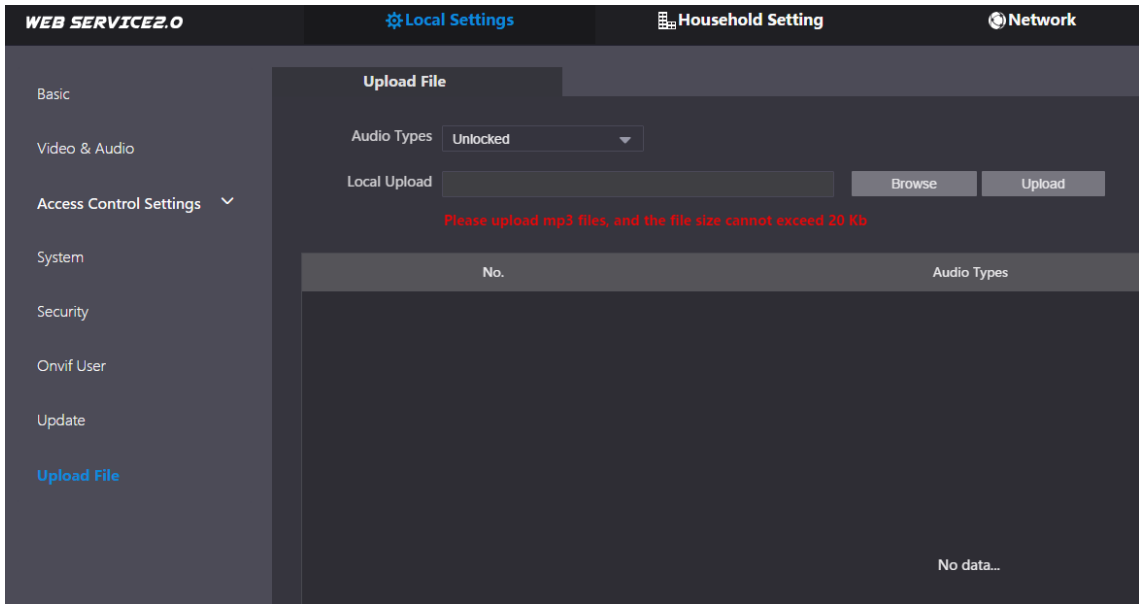

Step 3 Click **Upload**.

5 Household Setting

This chapter introduces how to add, modify, and delete VTO, VTH, VTS, and IPC, and how to send messages from the SIP server to VTOs and VTHs when the VTO works as the SIP server. If you are using other servers as the SIP server, see the corresponding manual for details.



To configure SIP server parameters, see "SIP Server" for details.

5.1 VTO No. Management

You can add VTOs to the SIP server, and all the VTOs connected to the same SIP server can call each other.

Step 1 Log in to the web interface of the VTO working as the SIP server, and then select **Household Setting > VTO No. Management**.

Figure 5-1 VTO management

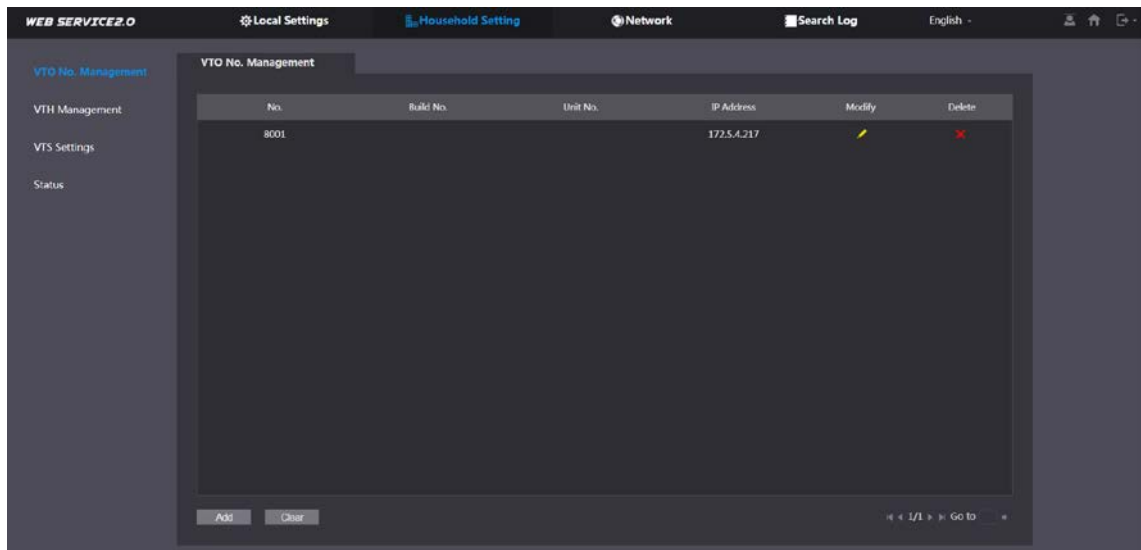

Step 2 Click **Add**.

Figure 5-2 Add VTO

The 'Add' dialog box contains the following fields:

- No. (empty text input)
- Registration Password (password input, masked with dots)
- Build No. (empty text input)
- Unit No. (empty text input)
- IP Address (text input, containing '127.0.0.1')
- Username (empty text input)
- Password (password input, masked with dots)

At the bottom of the dialog, there are 'Save' and 'Cancel' buttons.

Step 3 Configure the parameters.





The SIP server must be added.

Table 5-1 Add VTO configuration

Parameter	Description
No.	The VTO number you configured. See Table 4-1 for details.
Registration Password	Keep it default.
Build No.	Available only when other servers work as the SIP server.
Unit No.	
IP Address	IP address of the VTO.
Username	Web interface login username and password of the VTO.
Password	

Step 4 Click **Save**.



Click  or  to modify or delete a VTO, or **Clear** to delete all added VTOs, but the one that you have logged in to cannot be modified or deleted.

5.2 VTH Management

5.2.1 Adding Room Number

You can add the planned room number to the SIP server, and then configure the room number on VTH devices to connect them to the network. This section is applicable when the VTO works as the SIP server, and if you use other servers as SIP server, see the corresponding manual of the servers for detailed configuration.



The room number can contain at most 6 digits of numbers or letters or their combination, and it cannot be the same as any VTO number.

Using the VTO in a Villa

Step 1 Log in to the web interface of the SIP server, and then select **Local Settings > Basic**.

Figure 5-3 Device properties (1)

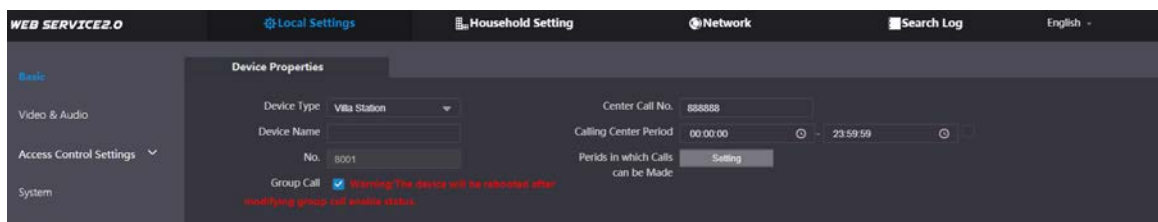

Step 2 Set **Device Type** to **Villa Station**, and then click **Save**.

Step 3 Select **Household Setting > VTH Management**.

Figure 5-4 Room number management

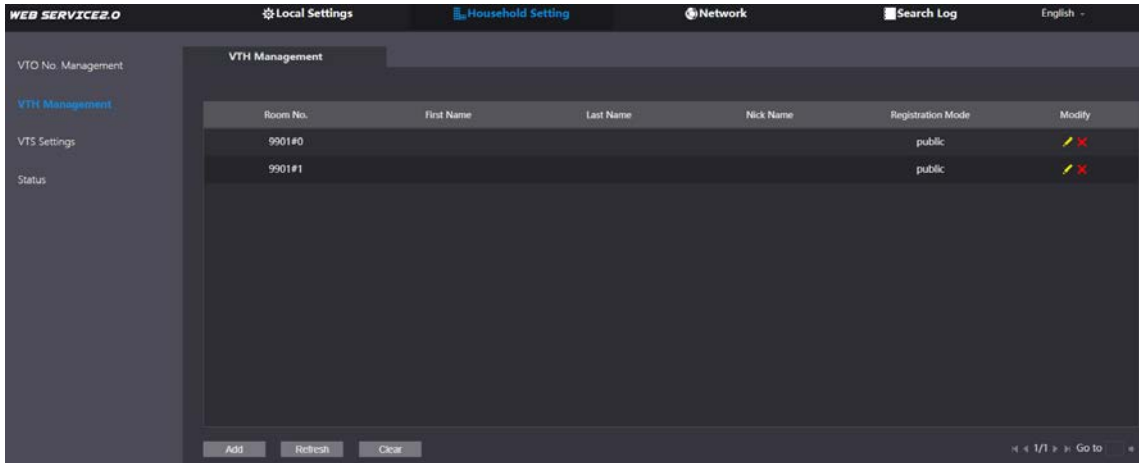

Step 4 Click **Add**.

Figure 5-5 Add a room number

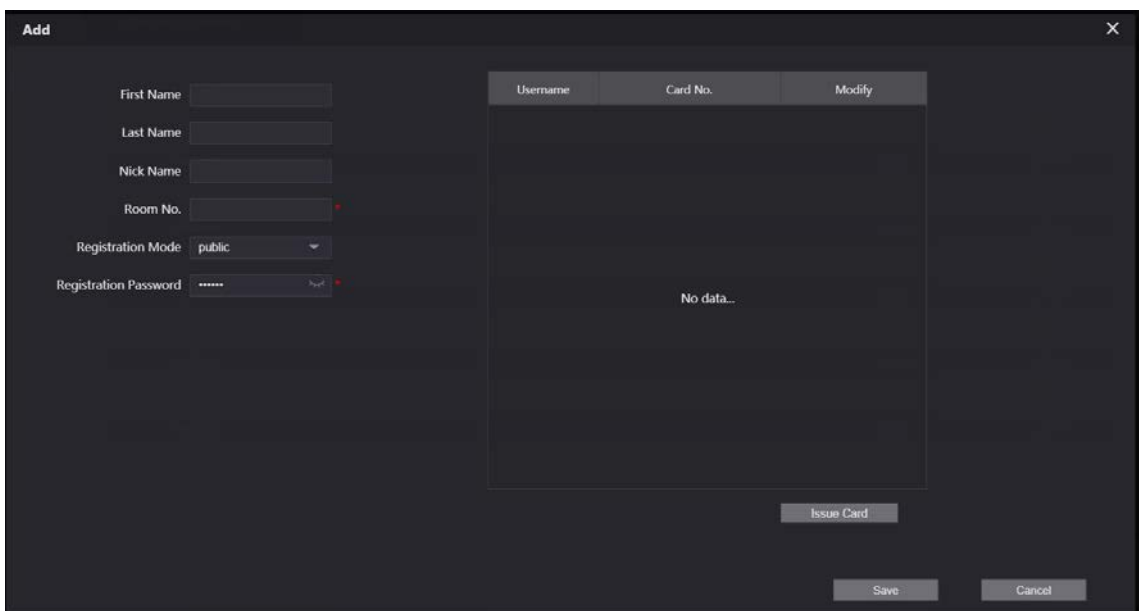



Step 5 Configure the parameters on the left.

Table 5-2 Room information

Parameter	Description
First Name	Enter the information you need to differentiate each room.
Last Name	
Nick Name	
Room No.	Enter a room number, and then configure the number on a VTH to connect to connect it to the network.
Registration Type	Select public .
Registration Password	Keep it default.

Step 6 Click **Save**.



- Click  or  to modify or delete a room number.
- Click **Clear** to delete all room numbers.

Using the VTO in a Small Apartment

Step 1 Log in to the web interface of the SIP server, and then select **Local Settings > Basic**.

Figure 5-6 Device properties (2)

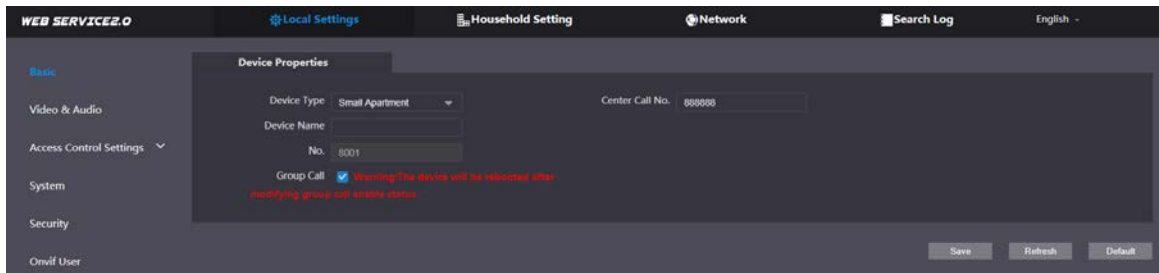

Step 2 Set **Device Type** to **Small Apartment**, and then click **Save**.

Step 3 Select **Household Setting > VTH Management**. You can add a single room number or add them in batches.

- Add a single room number.

Figure 5-7 Add room numbers

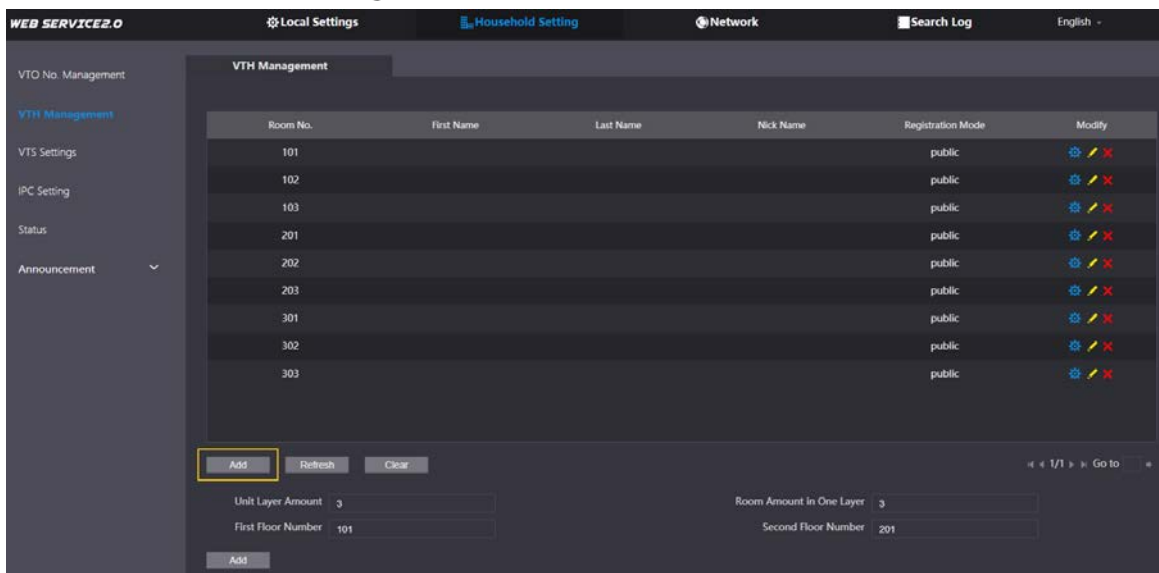



- 1) Click **Add**.

Figure 5-8 Add a single room number

- 2) Configure the information on the left. See Table 5-2 for details.
- 3) Click **Save**.
 - Adding multiple room numbers.

Figure 5-9 Add room numbers in batches

- 1) Configure the information.
 - ◇ **Unit Layer Amount:** The number of floors in the apartment.
 - ◇ **Room Amount in One Layer:** The number of rooms in one floor.
 - ◇ **First Floor Number:** The first room number on the first floor.
 - ◇ **Second Floor Number:** The first room number on the second floor.
- 2) Click **Add**, and then click **Refresh** to view the latest status
 - Click  or  to modify or delete a room number.
 - Click **Clear** to delete all room numbers.

5.2.2 Issuing Access Card

Issue an access card to unlock the door of a room.



To use this function, the VTO must have a card reader.

Step 1 Select **Household Setting > VTH Management**, click **Add**, and then click **Issue Card**.

Figure 5-10 Countdown notice

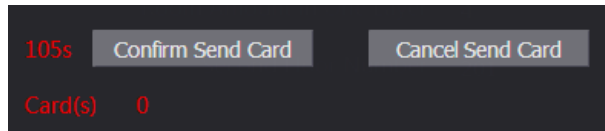

Step 2 Swipe the card on the VTO.

Figure 5-11 Issue card

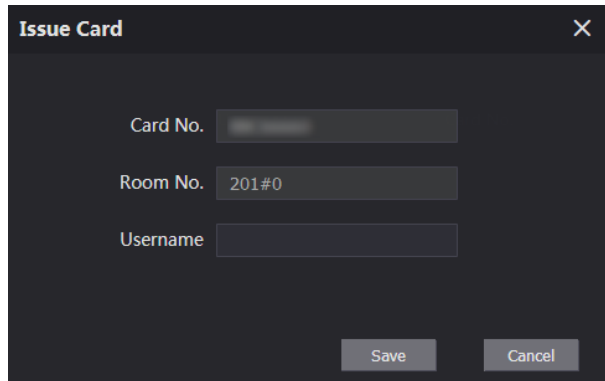





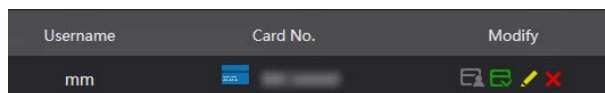

Step 3 Enter the username, click **Save**, and then click **Confirm Send Card**.

Figure 5-12 Issued access card



Other Operations

- Click  to set it to the main card, and then the icon changes to . The main card can be used to issue access cards for this room on the VTO.
- Click  to set it to loss, and then the icon changes to . The lost card cannot be used to open the door.
- Click  or  to modify the username or delete the card.

5.2.3 Issuing Fingerprint

Issue fingerprints to unlock the door of a room.



To use this function, the VTO must have a fingerprint scanner.

Step 1 Select **Household Setting > VTH Management**, click **Add**, and then click **Issue Fingerprint**.

Figure 5-13 Issue fingerprint

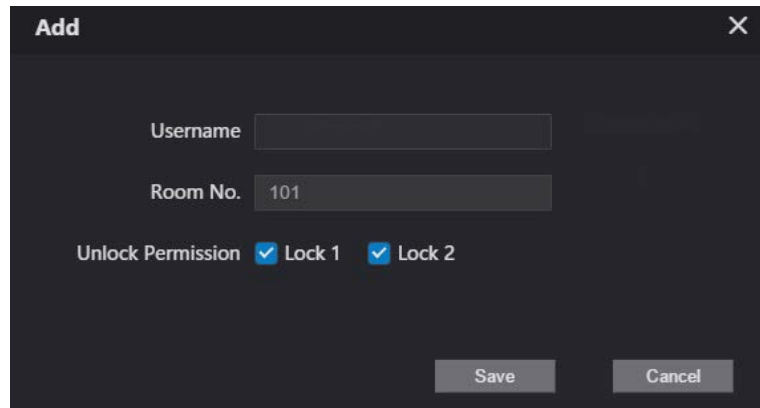

The screenshot shows a dark-themed 'Add' dialog box. It has a title bar with 'Add' and a close button. The form contains the following elements:

- 'Username' label followed by an empty text input field.
- 'Room No.' label followed by a text input field containing '101'.
- 'Unlock Permission' label followed by two checked checkboxes: 'Lock 1' and 'Lock 2'.
- 'Save' and 'Cancel' buttons at the bottom right.

Step 2 Enter a username, assign unlock permission as needed, and then click **Save**.

Step 3 Press your fingerprint on the scanner.

5.3 VTS Management

You can add a VTS to the SIP server, and then it can be used as the management center. It can also manage, call, or receive calls from all the VTOs and VTHs in the network. See the corresponding user's manual for details.

Step 1 Log in to the web interface of the VTO working as the SIP server, and then select **Household Setting > VTS Settings**.

Figure 5-14 VTS management

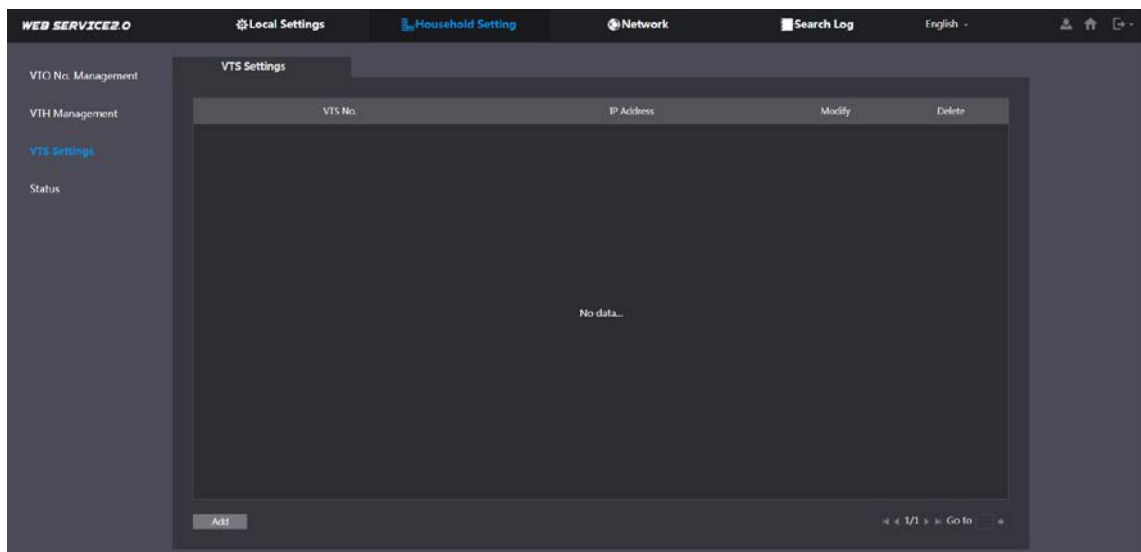

Step 2 Click **Add**.

Figure 5-15 Add VTS

Step 3 Configure the parameters.

Table 5-3 Add VTS configuration

Parameter	Description
VTS No.	The number of the VTS.
Registration Password	Keep it default.
IP Address	VTS IP address.

Step 4 Click **Save**.

5.4 IPC Setting

You can add IPC and NVR to the VTO working as the SIP server, and then all the connected VTHs can monitor them.



Interfaces might vary with different products. The actual interface shall prevail.

Step 1 Log in to the web interface of the VTO working as the SIP server, and then select **Household Setting > IPC Setting**.

Figure 5-16 IPC setting

IPC Name	IP Addr.	Username	Port No.	Protocol	Stream	Channel	Device Type	Modify	Delete
IPC1	0.0.0.0	admin	554	Local	Main	1	IPC	✍	✖
IPC2	0.0.0.0	admin	554	Local	Extra1	1	IPC	✍	✖
IPC3	0.0.0.0	admin	554	Local	Extra1	1	IPC	✍	✖
IPC4	0.0.0.0	admin	554	Local	Extra1	1	IPC	✍	✖
IPC5	0.0.0.0	admin	554	Local	Extra1	1	IPC	✍	✖
IPC6	0.0.0.0	admin	554	Local	Extra1	1	IPC	✍	✖
IPC7	0.0.0.0	admin	554	Local	Extra1	1	IPC	✍	✖
IPC8	0.0.0.0	admin	554	Local	Extra1	1	IPC	✍	✖
IPC9	0.0.0.0	admin	554	Local	Extra1	1	IPC	✍	✖
IPC10	0.0.0.0	admin	554	Local	Extra1	1	IPC	✍	✖
IPC11	0.0.0.0	admin	554	Local	Extra1	1	IPC	✍	✖
IPC12	0.0.0.0	admin	554	Local	Extra1	1	IPC	✍	✖
IPC13	0.0.0.0	admin	554	Local	Extra1	1	IPC	✍	✖
IPC14	0.0.0.0	admin	554	Local	Extra1	1	IPC	✍	✖

Step 2 Click .

Figure 5-17 Add IPC

The screenshot shows a 'Modify' dialog box with the following fields and values:

- IPC Name: [Empty]
- IP Address: 0.0.0.0
- Username: admin
- Password: [Masked]
- Port: 554
- Protocol: Local
- Stream Type: Extra1
- Channel: 1
- Device Type: IPC
- MediaEncrypt: OFF (radio button selected)

Buttons: Save, Cancel

Step 3 Configure the parameters.

Table 5-4 Add IPC configuration

Parameter	Description
IPC Name	Enter the name that identifies the IPC.
IP Address	IP address of the IPC.
Username	Web interface login username and password of the device.
Password	
Port	Keep it default.
Protocol	Select Local or Onvif .
Stream Type	<ul style="list-style-type: none"> ● Main: Better video quality but requires more bandwidth. ● Extra1: Smoother video with poorer quality, but requires less bandwidth.
Channel	The number of the channels that a device supports.
Device Type	Select the one as needed.
MediaEncrypt	Select ON if the IPC to be added is encrypted.

Step 4 Click **Save**.

Other Operations

- **Export Config**: Export the device information to your PC.
- **Import Config**: Import device information.

5.5 Status

You can view the online status and IP addresses of all the connected devices.

Log in to the web interface of the SIP server, and then select **Household Setting > Status**.

Figure 5-18 Status

Room No.	Status	IP-Port	Reg Time	Off Time
201#0	Online	192.168.1.100	2018-10-09 02:01:58	0
201#1	Online	192.168.1.101	2018-10-09 02:02:11	0
12	Online	192.168.1.102	2018-10-09 02:02:15	0
11	Online	192.168.1.103	2018-10-09 02:06:20	0

5.6 Publish Information

You can send messages from the SIP server to VTH devices, and view message history.

5.6.1 Send Info

Step 1 Log in to the web interface of the SIP server, and then select **Household Setting > Publish Information > Send Info**.

Figure 5-19 Send information

Validity Period: 2000-01-16 23:59:59

Send to: All devices

Title:

Contents:

Confirm Refresh

Step 2 Specify the **Validity Period** that the message will be valid.

Step 3 Enter the VTO number or VTH number, or select **All devices** to send the message to all the devices in the network, and then enter the title and content of your message.

Step 4 Click **Confirm**.

5.6.2 History Info

You can view the information of sent messages.

Log in to the web interface of the SIP server, select **Household Setting > Publish Information > History Info**.

Figure 5-20 History information

IssueTime	Period of validity	Title	Delete
2018-10-09 16:52:31	2018-10-09 16:54:00		X
2018-10-09 16:52:31	2018-10-09 16:53:00		X
2018-10-09 03:15:38	2018-10-09 16:52:00		X

6 Network

This chapter introduces how to configure the network parameters.

6.1 Basic

6.1.1 TCP/IP

You can modify the IP address, subnet mask, default gateway, and DNS of the VTO.

Step 1 Select **Network > Basic**.

Figure 6-1 TCP/IP and port

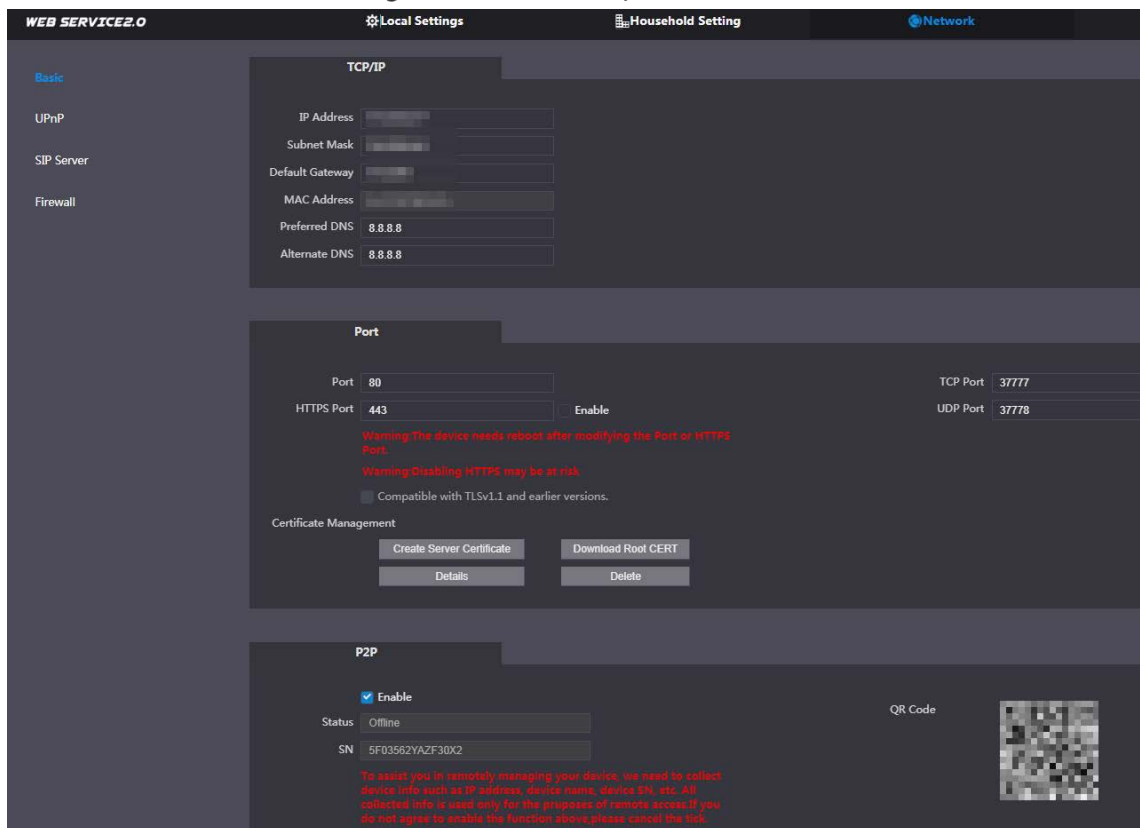



Step 2 Configure the parameters, and then click **Save**.

The VTO will restart, and you need to modify the IP address of your PC to the same network segment as the VTO to log in again.

6.1.2 Port

Table 6-1 Parameter description

Parameter	Description
Port	80 by default. If already used, choose any number from 1025 to 65535 as needed. You can enter <code>http://VTO IP address:Port</code> to log in to the VTO.
HTTPS Port	Enable it and click Save . You can now enter <code>https://VTO IP address:HTTPS Port</code> to

Parameter	Description
	log in to the VTO.
TCP/UDP Port	Used for accessing the VTO with devices in other networks. See "6.2 UPnP" for details.
Create Server Certificate	<p>The unique digital identification of VTO for the SSL protocol. For first-time use or after changing the IP address of the VTO, you need to go through this process.</p>  <p>If you delete the certificate that has been created, it cannot be undone.</p>
Download Root CERT	<p>If you are using a PC that has never logged in to the VTO, you need to download the root certificate, double-click to install it, and then you can use the HTTPS function mentioned above.</p>  <p>If you delete the certificate that has been installed, it cannot be undone.</p>

6.1.3 P2P

Enable the **P2P** function, and then you can scan the QR code with your phone to add the VTO to the app on your smartphone.



If you set **Device type** to **Small Apartment** (see "4.1 Basic"), the QR code will be relocated to

Household Setting > VTH Management. Click  of any room number, and then you can see

both the serial number and the QR code of the VTO.

6.2 UPnP

When the VTO works as the SIP server, you can configure the UPnP function to allow WAN devices to log in to the VTO.

Preparation

- Enable the UPnP function on the router, and then configure a WAN IP address for the router.
- Connect the VTO to the LAN port of the router.

6.2.1 Enabling UPnP Services

Step 1 Select **Network > UPnP**.

Step 2 Enable the services listed as needed.

Step 3 Select **Enable**.

Step 4 Click **Save**.

6.2.2 Adding UPnP Services

- Step 1 Select **Network > UPnP**.
- Step 2 Click **Add**.
- Step 3 Configure the parameters as needed.

Figure 6-2 Add a UPnP service

Table 6-2 Parameter description

Parameter	Description
Service Name	Enter the information as needed.
Service Type	
Protocol	Select TCP or UDP as needed.
Internal Port	Use port number from 1024 through 5000.
External Port	 <ul style="list-style-type: none"> Do not use port number 1–1023 to avoid conflict. If you need to configure this function for multiple devices, make sure that the ports are not the same. The port number you use must not be occupied. The internal and external port number must be the same.

6.3 SIP Server

There must be a SIP server in the network for all connected VTOs and VTHs to call each other. You can use a VTO or other servers as the SIP server.

- Step 1 Select **Network > SIP Server**.

Figure 6-3 SIP Server

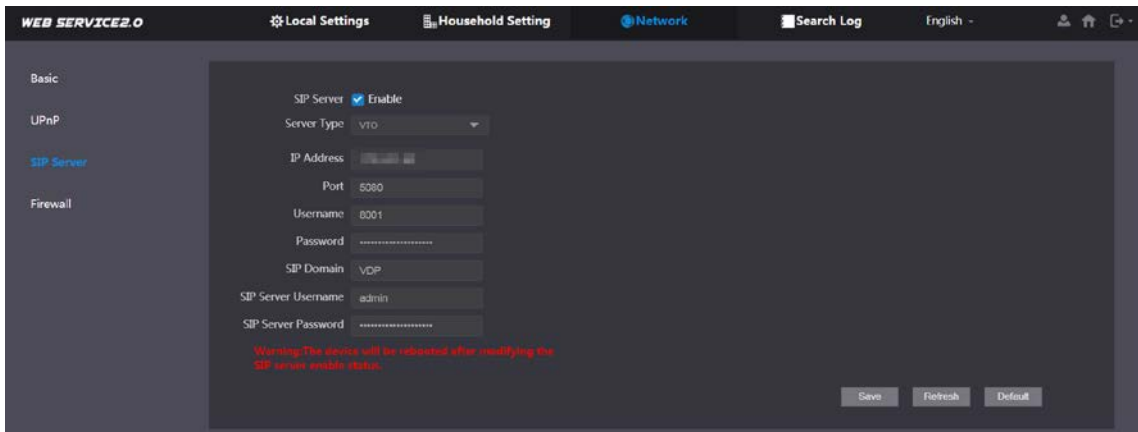

Step 2 Select a server type as needed.

- The VTO you have logged in as the SIP server:
Enable **SIP Server**, and click **Save**, and then the VTO will restart. You can add VTOs and VTHs to this VTO. See the details in "5 Household Setting".



If the VTO you have logged in does not SIP server, do not enable **SIP Server**; otherwise the connection will fail.

- If another VTO works as the SIP server:
Do not enable **SIP server**. Set **Server Type** to **VTO**, configure the parameters, and then click **Save**.

Table 6-3 SIP server configuration

Parameter	Description
IP Addr.	VTO IP address.
Port	<ul style="list-style-type: none"> • 5060 by default when VTO work as SIP server. • 5080 by default when the platform works as SIP server.
Username	Keep it default.
Password	
SIP Domain	VDP.
SIP Server Username	Web interface login username and password of the VTO.
SIP Server Password	

- If other servers work as the SIP server:
Select the **Server Type** as needed, and then see the corresponding manual for details.

6.4 Firewall

You can enable different firewall types to control network access to the VTO.

Step 1 Select **Network > Firewall**.

Figure 6-4 Firewall

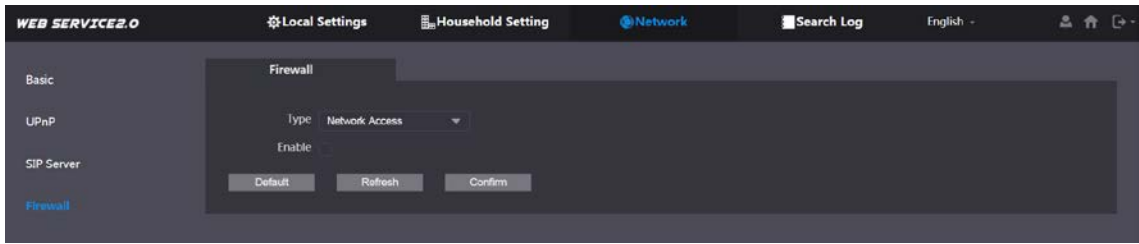

Step 2 Select one or more firewall types, and then enable them.

Step 3 Configure the parameters.

Table 6-4 Firewall type description

Type	Description
Network Access	Select either Allowlist or Blocklist , and then add an IP address or segment which is allowed or denied to access the VTO.
PING Prohibited	The VTO will not response to ping to avoid ping attacks.
Anti-semijoin	Protects the VTO performance by blocking excessive SYN packets.

7 Log Management

Select **Search Log**, and then you can view call history, alarm records, unlock records, and various system logs, and export them to your PC as needed.



If storage is full, the oldest records will be overwritten. Back up the records as needed.

Appendix 1 Cybersecurity Recommendations

Cybersecurity is more than just a buzzword: it's something that pertains to every device that is connected to the internet. IP video surveillance is not immune to cyber risks, but taking basic steps toward protecting and strengthening networks and networked appliances will make them less susceptible to attacks. Below are some tips and recommendations on how to create a more secured security system.

Mandatory actions to be taken for basic device network security:

1. Use Strong Passwords

Please refer to the following suggestions to set passwords:

- The length should not be less than 8 characters;
- Include at least two types of characters; character types include upper and lower case letters, numbers and symbols;
- Do not contain the account name or the account name in reverse order;
- Do not use continuous characters, such as 123, abc, etc.;
- Do not use overlapped characters, such as 111, aaa, etc.;

2. Update Firmware and Client Software in Time

- According to the standard procedure in Tech-industry, we recommend to keep your device (such as NVR, DVR, IP camera, etc.) firmware up-to-date to ensure the system is equipped with the latest security patches and fixes. When the device is connected to the public network, we recommend enabling the "auto-check for updates" function to obtain timely information of firmware updates released by the manufacturer.
- We suggest that you download and use the latest version of client software.

"Nice to have" recommendations to improve your device network security:

1. Physical Protection

We suggest that you perform physical protection to device, especially storage devices. For example, place the device in a special computer room and cabinet, and implement well-done access control permission and key management to prevent unauthorized personnel from carrying out physical contacts such as damaging hardware, unauthorized connection of removable device (such as USB flash disk, serial port), etc.

2. Change Passwords Regularly

We suggest that you change passwords regularly to reduce the risk of being guessed or cracked.

3. Set and Update Passwords Reset Information Timely

The device supports password reset function. Please set up related information for password reset in time, including the end user's mailbox and password protection questions. If the information changes, please modify it in time. When setting password protection questions, it is suggested not to use those that can be easily guessed.

4. Enable Account Lock

The account lock feature is enabled by default, and we recommend you to keep it on to guarantee the account security. If an attacker attempts to log in with the wrong password several times, the corresponding account and the source IP address will be locked.

5. Change Default HTTP and Other Service Ports

We suggest you to change default HTTP and other service ports into any set of numbers between 1024~65535, reducing the risk of outsiders being able to guess which ports you are using.

6. Enable HTTPS

We suggest you to enable HTTPS, so that you visit Web service through a secure communication channel.

7. MAC Address Binding

We recommend you to bind the IP and MAC address of the gateway to the device, thus reducing the risk of ARP spoofing.

8. Assign Accounts and Privileges Reasonably

According to business and management requirements, reasonably add users and assign a minimum set of permissions to them.

9. Disable Unnecessary Services and Choose Secure Modes

If not needed, we recommend turning off some services such as SNMP, SMTP, UPnP, etc., to reduce risks.

If necessary, it is highly recommended that you use safe modes, including but not limited to the following services:

- SNMP: Choose SNMP v3, and set up strong encryption passwords and authentication passwords.
- SMTP: Choose TLS to access mailbox server.
- FTP: Choose SFTP, and set up strong passwords.
- AP hotspot: Choose WPA2-PSK encryption mode, and set up strong passwords.

10. Audio and Video Encrypted Transmission

If your audio and video data contents are very important or sensitive, we recommend that you use encrypted transmission function, to reduce the risk of audio and video data being stolen during transmission.

Reminder: encrypted transmission will cause some loss in transmission efficiency.

11. Secure Auditing

- Check online users: we suggest that you check online users regularly to see if the device is logged in without authorization.
- Check device log: By viewing the logs, you can know the IP addresses that were used to log in to your devices and their key operations.

12. Network Log

Due to the limited storage capacity of the device, the stored log is limited. If you need to save the log for a long time, it is recommended that you enable the network log function to ensure that the critical logs are synchronized to the network log server for tracing.

13. Construct a Safe Network Environment

In order to better ensure the safety of device and reduce potential cyber risks, we recommend:

- Disable the port mapping function of the router to avoid direct access to the intranet devices from external network.
- The network should be partitioned and isolated according to the actual network needs. If there are no communication requirements between two sub networks, it is suggested to use VLAN, network GAP and other technologies to partition the network, so as to achieve the network isolation effect.
- Establish the 802.1x access authentication system to reduce the risk of unauthorized access to private networks.
- Enable IP/MAC address filtering function to limit the range of hosts allowed to access the device.

Modular Door Station

Quick Start Guide



Foreword

General

This document mainly introduces product function, structure, networking, mounting process, debugging process, and web operations of the modular door station (hereinafter referred to as "VTO").

Models





VTO4202F-MK, VTO4202F-MB1, VTO4202F-MB2, VTO4202F-MB5, VTO4202F-MR, VTO4202F-MS, VTO4202F-MF, VTO4202F-ML, VTO4202F-MA, VTO4202F-P, and VTO4202F-P-S2.

Device Update

Power supply can be cut off only after the device has completed update and restarted.

Safety Instructions

The following categorized signal words with defined meaning might appear in the manual.

Signal Words	Meaning
 DANGER	Indicates a high potential hazard which, if not avoided, will result in death or serious injury.
 WARNING	Indicates a medium or low potential hazard which, if not avoided, could result in slight or moderate injury.
 CAUTION	Indicates a potential risk which, if not avoided, could result in property damage, data loss, lower performance, or unpredictable result.
 TIPS	Provides methods to help you solve a problem or save you time.
 NOTE	Provides additional information as the emphasis and supplement to the text.

Revision History

Version	Revision Content	Release Time
V1.0.0	First release.	December, 2020

About the Manual

- The manual is for reference only. If there is inconsistency between the manual and the actual product, the actual product shall prevail.
- We are not liable for any loss caused by the operations that do not comply with the manual.

- The manual would be updated according to the latest laws and regulations of related regions. For detailed information, see the paper manual, CD-ROM, QR code or our official website. If there is inconsistency between paper manual and the electronic version, the electronic version shall prevail.
- All the designs and software are subject to change without prior written notice. The product updates might cause some differences between the actual product and the manual. Please contact the customer service for the latest program and supplementary documentation.
- There still might be deviation in technical data, functions and operations description, or errors in print. If there is any doubt or dispute, please refer to our final explanation.
- Upgrade the reader software or try other mainstream reader software if the manual (in PDF format) cannot be opened.
- All trademarks, registered trademarks and the company names in the manual are the properties of their respective owners.
- Please visit our website, contact the supplier or customer service if there is any problem occurred when using the device.
- If there is any uncertainty or controversy, please refer to our final explanation.

Important Safeguards and Warnings

The following description is the correct application method of the VTO. Read the manual carefully before use, in order to prevent danger and property loss. Strictly conform to the manual during application and keep it properly for future reference.

Operating Requirements

- Do not expose the device to direct sunlight or heat source.
- Do not install the device in a humid or dusty area.
- Install the device at stable places horizontally to prevent it from falling.
- Do not drip or splash liquids on the device, or put on the device anything filled with liquids.
- Install the device at well-ventilated places and do not block its vent.
- Use the device only within rated input and output range.
- Do not dismantle the device by yourself.
- Transport, use and store the device within allowed humidity and temperature range.

Power Requirements

- Use electric wires recommended in your area, and within their rated specification.
- Use power supply that meets SELV (safety extra low voltage) requirements, and supply power with rated voltage that conforms to Limited Power Source in IEC60950-1. For specific power supply requirements, see the label on the device.
- Appliance coupler is a disconnecting device. During normal use, keep an angle that facilitates operation.

Table of Contents

Foreword	I
Important Safeguards and Warnings	III
1 Overview	1
1.1 Introduction.....	1
1.2 Features.....	1
2 Structure	2
2.1 Camera Module.....	2
2.2 Indicator Module.....	3
2.3 Audio Module.....	4
2.4 Button Module.....	5
2.5 Keyboard Module (with Braille).....	6
2.6 Card Module.....	6
2.7 Fingerprint Module.....	7
2.8 Display Module.....	7
2.9 Blank Module.....	8
2.10 Cascade Connection.....	8
3 Configuration and Commissioning	9
3.1 Procedure.....	9
3.2 Configuring VTO.....	9
3.2.1 Initialization.....	9
3.2.2 Configuring VTO Number.....	10
3.2.3 Configuring Network Parameters.....	11
3.2.4 Configuring SIP Servers.....	11
3.2.5 Adding VTO.....	13
3.2.6 Adding Room Number.....	14
3.2.7 Configuring the Module.....	17
3.3 Commissioning.....	19
3.3.1 VTO Calling VTH.....	19
3.3.2 VTH Monitoring VTO.....	19
Appendix 1 Cybersecurity Recommendations	21

1 Overview

1.1 Introduction

You can build up the modular VTO with different modules, including the camera module, indicator module, button module, keyboard module, card module, fingerprint module, audio module, and display module. The camera and audio modules are indispensable, and the other ones can be added as needed.

1.2 Features

- Video call: Make video calls to indoor monitors (VTHs).
- Group call: Call multiple VTHs simultaneously.
- Video monitoring: Up to 6 VTHs can view the monitoring image of this VTO at the same time.
- Emergency call: Call the management center during an emergency.
- Unlock: Card, fingerprint, password and remote unlock.
- Alarm: Anti-tampering alarm, door contact alarm and duress password unlock alarm. Alarm information will be sent to the management center.
- Record search: Call records, alarm records and unlock records.

2 Structure

2.1 Camera Module

Figure 2-1 Front panel

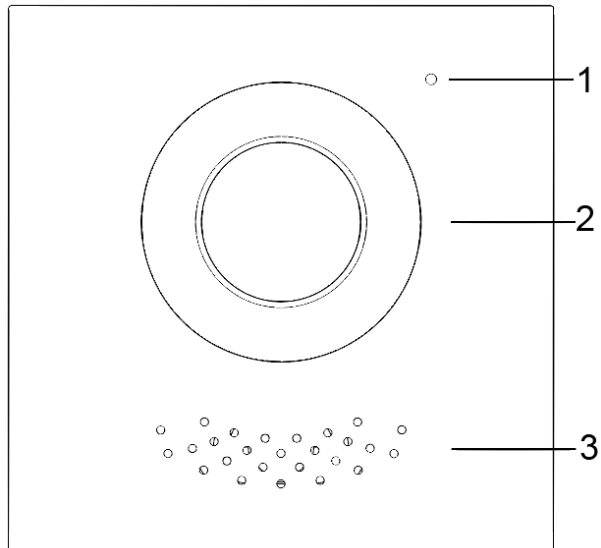

Table 2-1 Front panel description

No.	Name
1	Microphone
2	Camera
3	Speaker

Figure 2-2 Rear panel

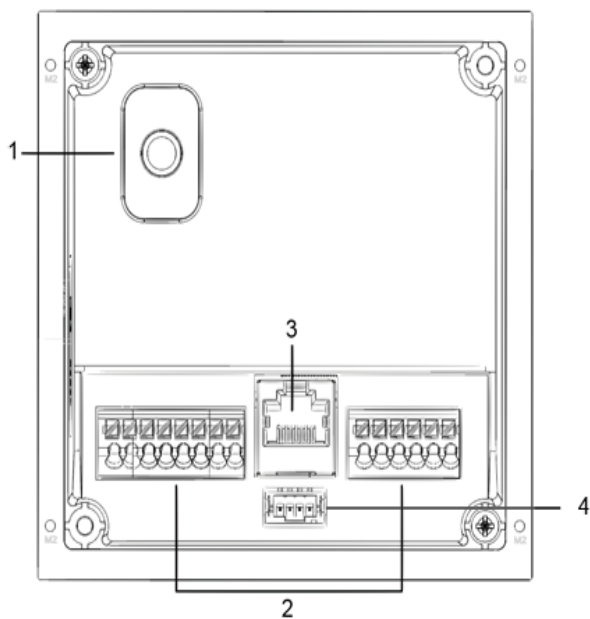

Table 2-2 Rear panel description

No.	Name	Description
1	Anti-tampering switch	When the VTO is removed from the wall forcibly, an alarm will be triggered and the alarm information will be sent to management center.
2	Ports	Connect to power supply, electric control lock, solenoid lock and exit button.
3	Ethernet port	Connect to network cables.
4	Cascade connection port	Connect to other modules.

Figure 2-3 Ports description

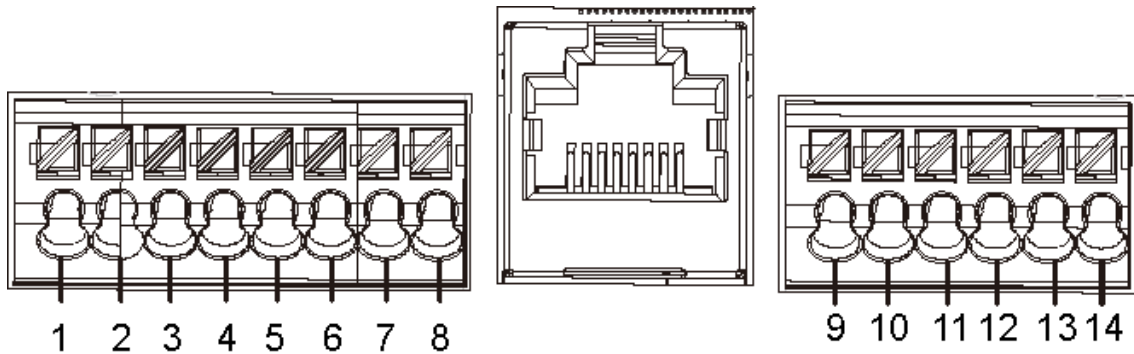

Table 2-3 Port description

No.	Description	No.	Description
1	GND	8	EOC1 (2wires -(GND) for a 2-wire camera module)
2	+12V_OUT	9	DOOR_BUTTON
3	RS-485_B	10	DOOR_FEEDBACK
4	RS-485_A	11	GND
5	ALARM_NO	12	DOOR_NC
6	ALARM_COM	13	DOOR_COM
7	EOC2 (2wires +(48V) for a 2-wire camera module)	14	DOOR_NO

2.2 Indicator Module

Figure 2-4 Front panel

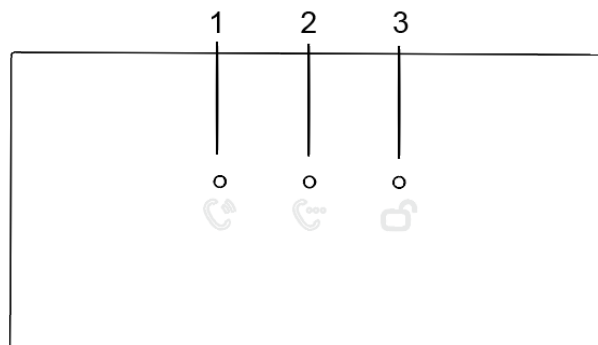

Table 2-4 Indicator module description (1)

No.	Name	Description
1	Call indicator	Activity status.
2	Talk indicator	
3	Unlock indicator	

Figure 2-5 Rear panel of indicator module

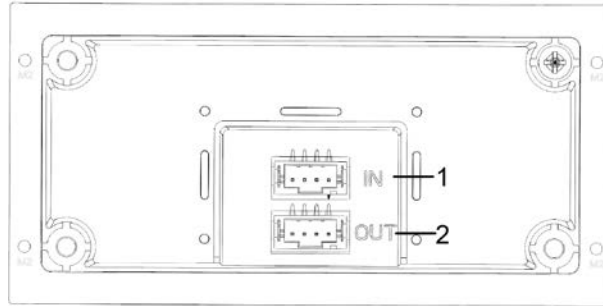

Table 2-5 Indicator module description (2)

No.	Name	Description
1	Cascade input	Connect to other modules.
2	Cascade output	

2.3 Audio Module



The rear panel of audio module is the same as the camera module.

Figure 2-6 Audio module

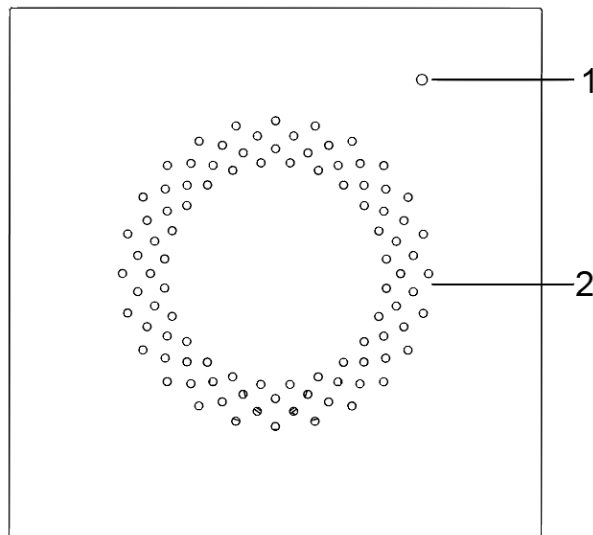

Table 2-6 Audio module description

No.	Name
1	Microphone
2	Speaker

2.4 Button Module

One-button module, two-button module, and five-button module are available with the same function. Here we take the five-button module as an example.

Figure 2-7 Front panel of the five-button module

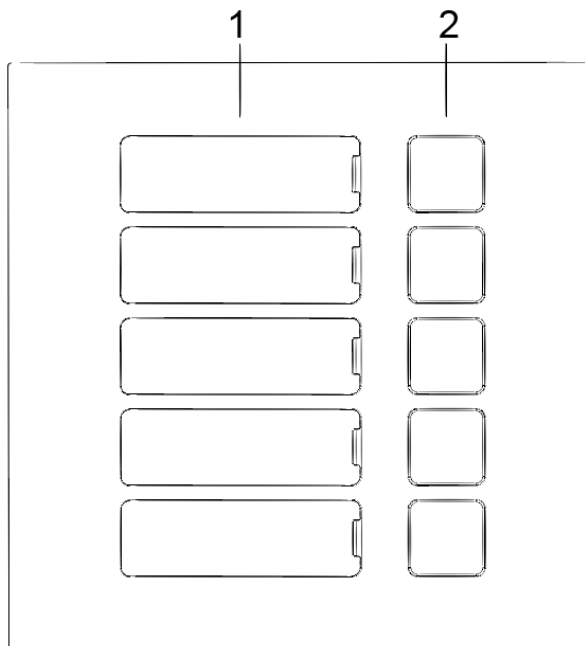

Table 2-7 Front panel description

No.	Name	Description
1	User directory	Put name cards here.
2	Call buttons	<p>Call other VTHs or the management center.</p>  <p>Configure related parameters on the web interface first.</p>

Figure 2-8 Rear panel of the five-button module

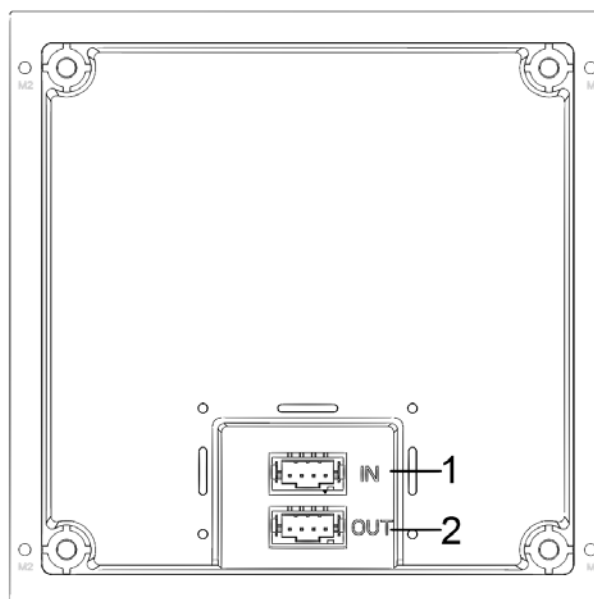

Table 2-8 Rear panel description

No.	Name
1	Cascade input
2	Cascade output

2.5 Keyboard Module (with Braille)



The rear panel of keyboard module is the same as the button module.

Figure 2-9 Keyboard module

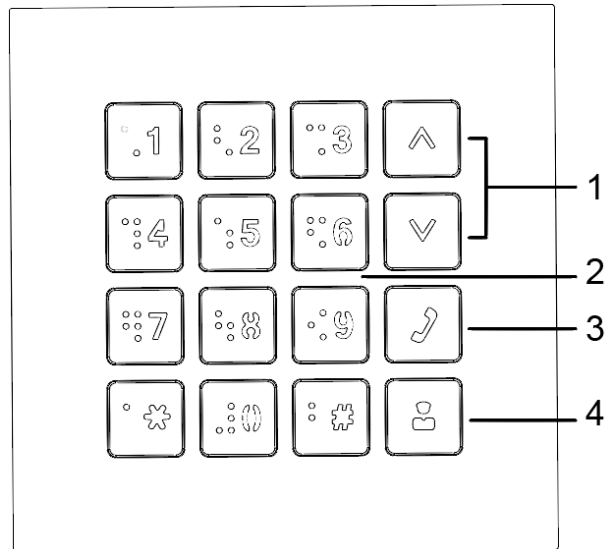

Table 2-9 Keyboard module description

No.	Name	Description
1	Selection	—
2	Numbers	Enter password or VTH numbers.
3	Call	Call VTHs.
4	Call management center	—

2.6 Card Module

Swipe your card near the icon.



The rear panel of card module is the same as the button module.

Figure 2-10 Card module



2.7 Fingerprint Module

Collects and verifies fingerprints.



The rear panels of fingerprint module and button module have different port positions, but port functions are the same.

Figure 2-11 Fingerprint module

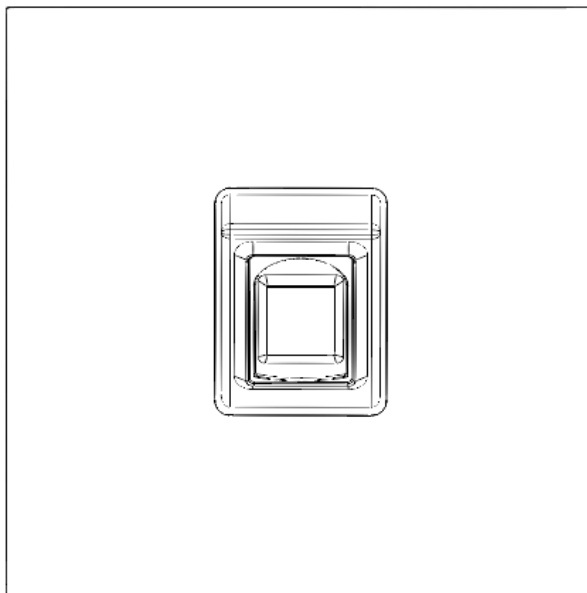

2.8 Display Module

Displays user information.



Rear panels of display module and button module have different port positions, but port functions are the same.

Figure 2-12 Display module

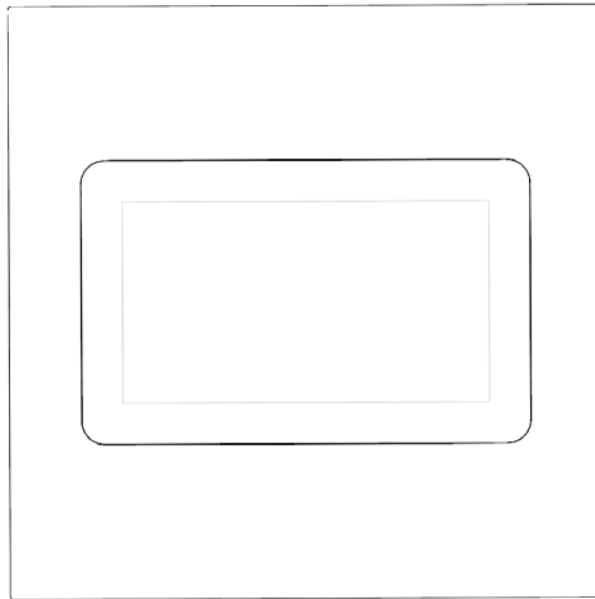

2.9 Blank Module

For a better appearance, use the blank module if there is an extra space while putting up modules together.

Figure 2-13 Blank module

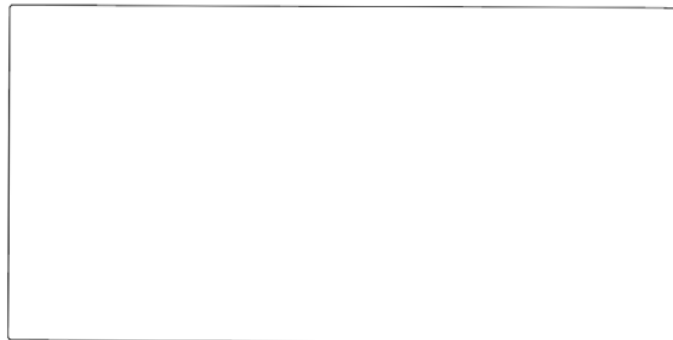

2.10 Cascade Connection

Cascade connection is needed for all the modules to work together.

Figure 2-14 Cascade connection example

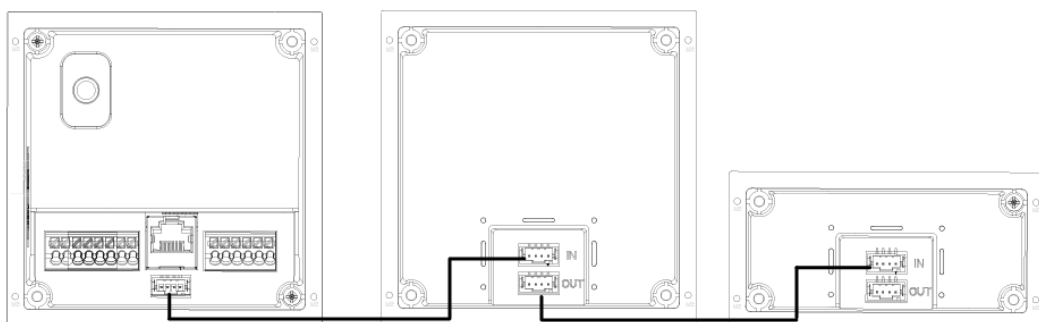

3 Configuration and Commissioning

This chapter introduces basic configurations to the VTO and VTH devices.



Interface and function might vary with the device type you configured for the VTO. The actual interface and function shall prevail.

3.1 Procedure



Before configuration, make sure that there is no short or open circuit.

Step 1 Plan IP and unit/room number (works as a phone number) for each device.

Step 2 Configure the VTO. See "3.2 Configuring VTO."

Step 3 Configure the VTH. See the VTH user's manual.

Step 4 Check if all settings are correct. See "3.3 Commissioning."

3.2 Configuring VTO

Connect the VTO to your PC with a network cable, and for first-time login, you need to create a new password for the web interface.

3.2.1 Initialization

Step 1 Power on the VTO.

Step 2 Go to the IP address of the VTO in the browser.



For first-time login, enter the default IP (192.168.1.108). If you have multiple VTOs, we recommend changing the default IP address (**Network > Basic**) to avoid conflict.

Figure 3-1 Device initialization

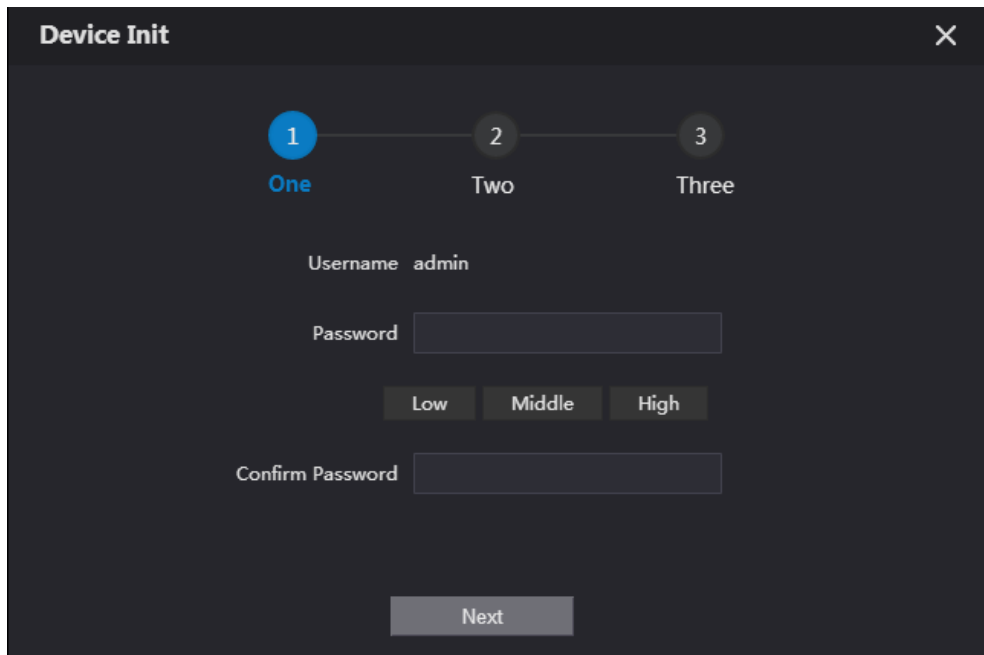

Step 3 Enter and confirm the password, and then click **Next**.

Step 4 Select **Email**, enter an email address for resetting password, and then click **Next**.

Step 5 Click **OK**. The system goes to the login interface.

3.2.2 Configuring VTO Number

Numbers can be used to distinguish each VTO, and we recommend setting it according to unit or building number.



You can change the number of a VTO when it is not working as the SIP server. A VTO number can contain 5 numbers at most, and it cannot be the same with any room number.

Step 1 Log in to the VTO web interface.

Figure 3-2 Main interface

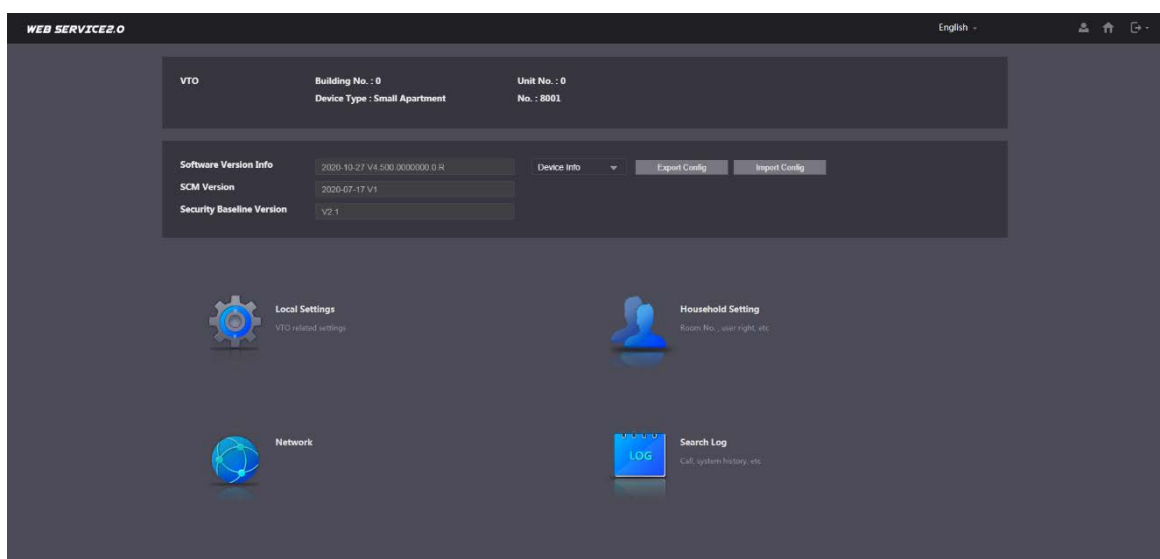

Step 2 Select **Local Settings > Basic**.

Figure 3-3 Device properties

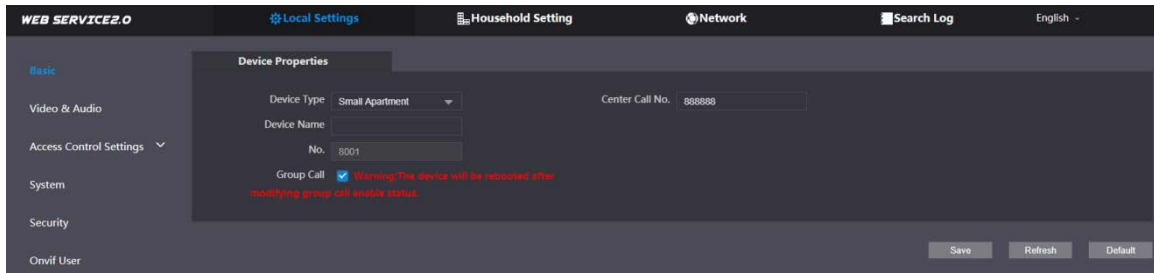

Step 3 Enter the number in **No.**, and then click **Save**.

3.2.3 Configuring Network Parameters

Step 1 Select **Network > Basic**.

Figure 3-4 TCP/IP information

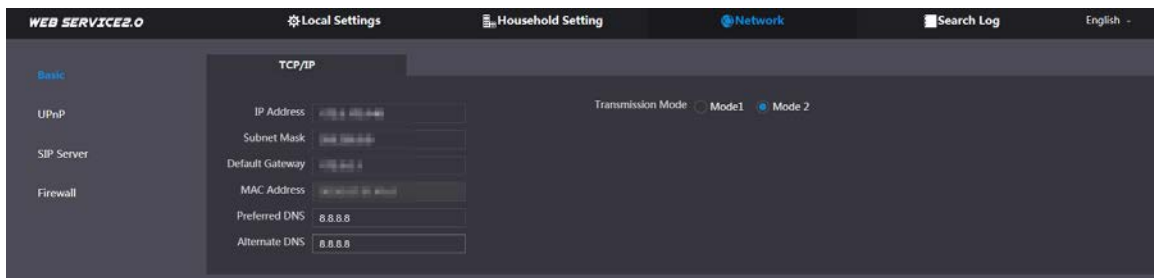

Step 2 Enter the parameters and click **Save**.

The VTO will automatically restart. You need to change the IP address of your PC to the same network segment as the VTO to log in again.

3.2.4 Configuring SIP Servers

When connected to the same SIP server, all VTOs and VTHs can call each other. You can use a VTO or other servers as the SIP server.



- If the current VTO is the SIP server, **Building No.** and **Unit No.** will not be displayed on the **Device Properties** interface.
- If you go to **Network Setting > SIP Server**, enable **Alternate Server** and log in to the web interface again, **Building No.** and **Unit No.** will be displayed on the **Device Properties** interface.

Step 1 Log in to the web interface.

Step 2 Select **Network > SIP Server**.

Figure 3-5 SIP server

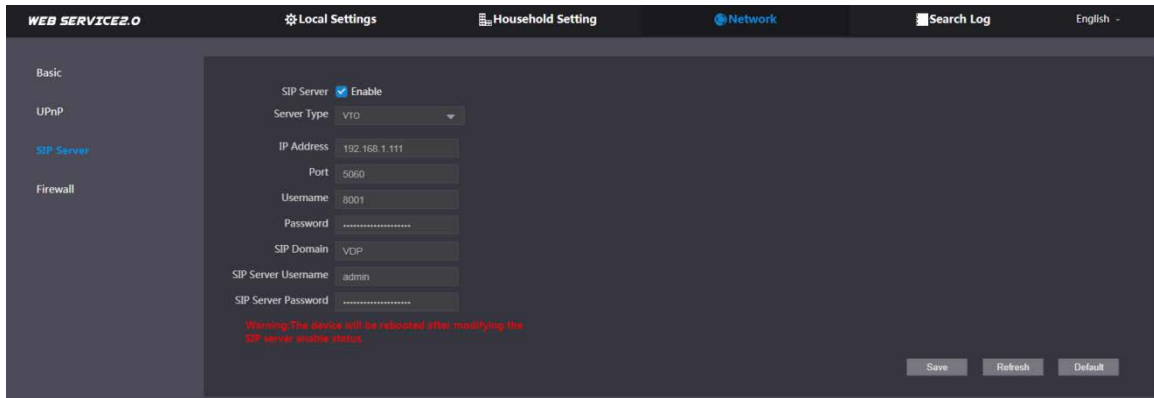

Step 3 Select a SIP server.

- VTO as SIP Server: This is applicable to only one building.
 - 1) Enable **SIP Server**.
 - 2) Select **Server Type** as **VTO**.
 - 3) Configure the parameters. See Table 3-1.
 - 4) Click **Save**. The VTO will restart automatically.
- Platform (Express/DSS) as SIP server: This is applicable to multiple buildings or units. If you do not have a platform, use a VTO as the SIP server.
 - 1) Disable **SIP Server**.
 - 2) Select **Server Type** to **Express/DSS**.
 - 3) Configure the parameters.

Table 3-1 SIP server parameter description

Parameter	Description
IP Address	IP address of the SIP server.  If Alternate Server is not enabled, the VTO cannot call the VTS.
Port	<ul style="list-style-type: none"> ● 5060 by default when VTO work as SIP server. ● 5080 by default when the platform works as SIP server.
Username/Password	Keep it default.
SIP Domain	<ul style="list-style-type: none"> ● Must be VDP when VTO works as SIP server. ● Keep it null or default when the platform works as SIP server.
SIP Server Username/Password	Used to log in to the SIP server.
Alternate IP Addr.	IP address of the alternate server.
Alternate Username	Alternate server login username and password.
Alternate Password	
Alternate VTS IP Addr.	IP address of the alternate VTS.
Alternate Server	<ul style="list-style-type: none"> ● After entering alternate IP address, username, password, and VTS IP address, you need to enable Alternate Server. ● After Alternate Server is enabled, you can only enter the VTS IP address, and the VTO will restart.

Step 4 Click **OK**, and the VTO will restart automatically.



When a platform works as the SIP server, enable **Support Building** and **Support Unit** first if it is necessary to set building number and building unit number.

3.2.5 Adding VTO

You can add VTO devices to the SIP server, and all the VTO devices connected to the same SIP server can make video call between each other. This section is applicable when a VTO device works as SIP server, and if you are using other servers as SIP server, see the corresponding manual for the detailed configuration.

Step 1 Log in to the web interface of the SIP server, and then select **Household Setting > VTO No. Management**.

Figure 3-6 VTO number management

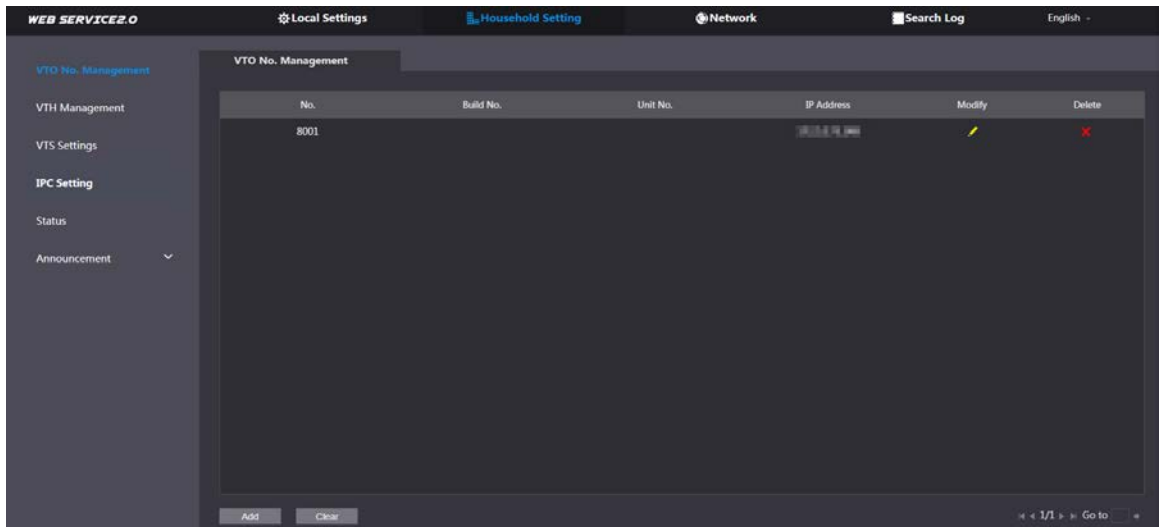

Step 2 Click **Add**.

Figure 3-7 Add VTO

Step 3 Configure the parameters.



The SIP server must be added.

Table 3-2 Add VTO

Parameter	Description
Rec No.	VTO number. See "3.2.2 Configuring VTO Number."
Register Password	Keep it default.
Build No.	Available only when other servers work as SIP server.
Unit No.	
IP Address	VTO IP address.
Username	VTO web interface login username and password.
Password	

Step 4 Click **Save**.

3.2.6 Adding Room Number

You can add the planned room number to the SIP server, and then configure the room number on VTH devices to connect them to the network. This section is applicable when the VTO works as the SIP server, and if you use other servers as SIP server, see the corresponding manual of the servers for detailed configuration.



The room number can contain at most 6 digits of numbers or letters or their combination, and it cannot be the same as any VTO number.

Using the VTO in a Villa

Step 1 Log in to the web interface of the SIP server, and then select **Local Settings > Basic**.

Figure 3-8 Device properties

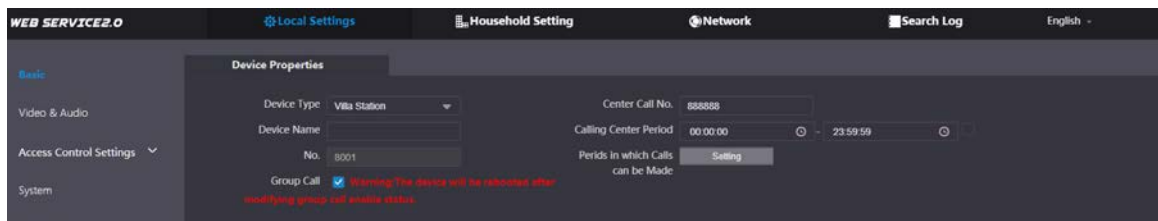

Step 2 Set **Device Type** to **Villa Station**, and then click **Save**.

Step 3 Select **Household Setting > VTH Management**.

Figure 3-9 Room number management

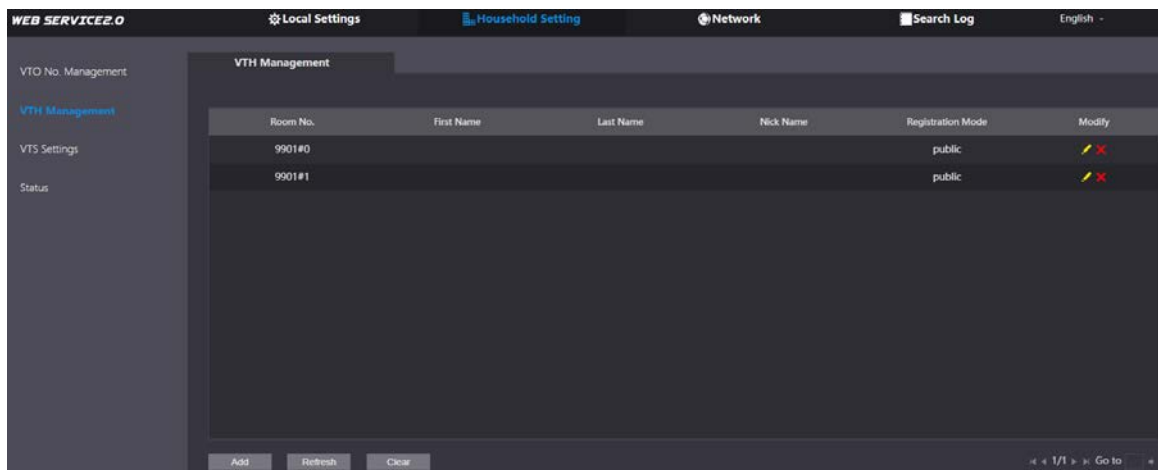

Step 4 Click **Add**.

Figure 3-10 Add a single room number

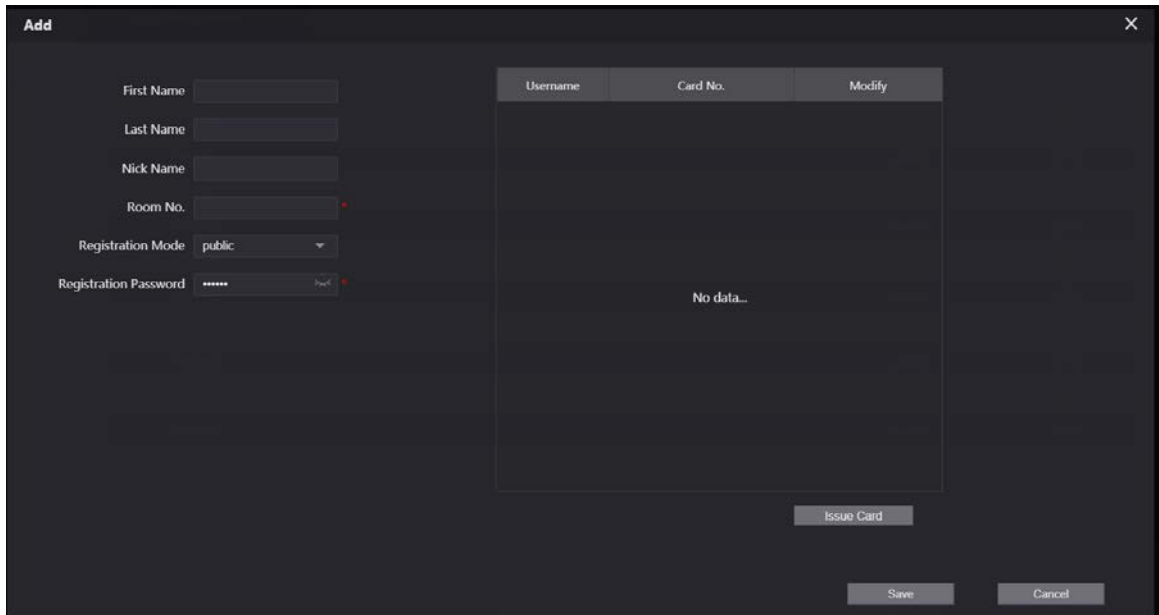



Step 5 Configure the information on the left.

Table 3-3 Room information

Parameter	Description
First Name	Information used to differentiate each room.
Last Name	
Nick Name	
Room No.	<ul style="list-style-type: none"> When there are multiple VTHs, the room number for the main VTH should end with #0, and the room numbers for sub VTHs with #1, #2... You can have up to 10 sub VTHs for one main VTH.
Registration Type	Select public .
Registration Password	Keep it default.

Step 6 Click **Save**.



- Click  or  to modify or delete a room number.
- Click **Clear** to delete all room numbers.

Using the VTO in a Small Apartment

Step 1 Log in to the web interface of the SIP server, and then select **Local Settings > Basic**.

Figure 3-11 Device properties

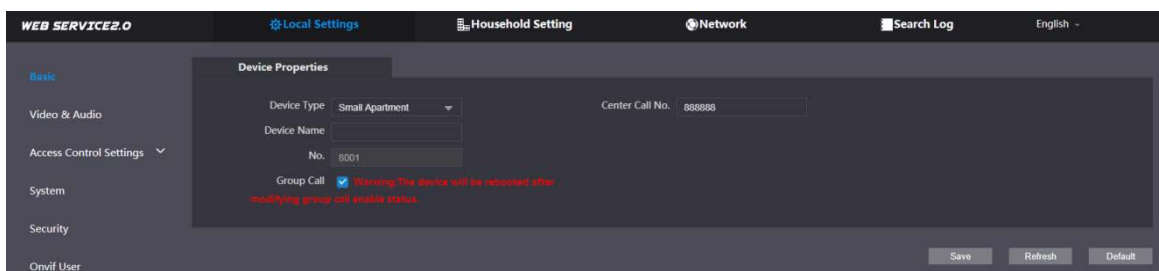

Step 2 Set **Device Type** to **Small Apartment**, and then click **Save**.

Step 3 Select **Household Setting > VTH Management**. You can add a single room number or add them in batches.

- Add a single room number.

Figure 3-12 Add room numbers

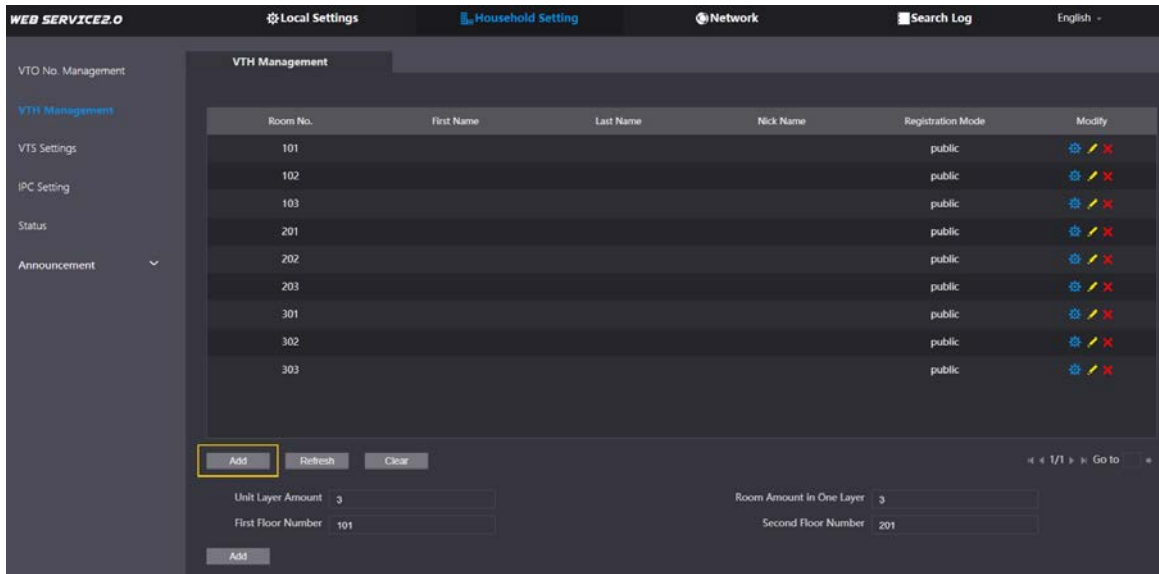

- 1) Click **Add**.

Figure 3-13 Add a single room number

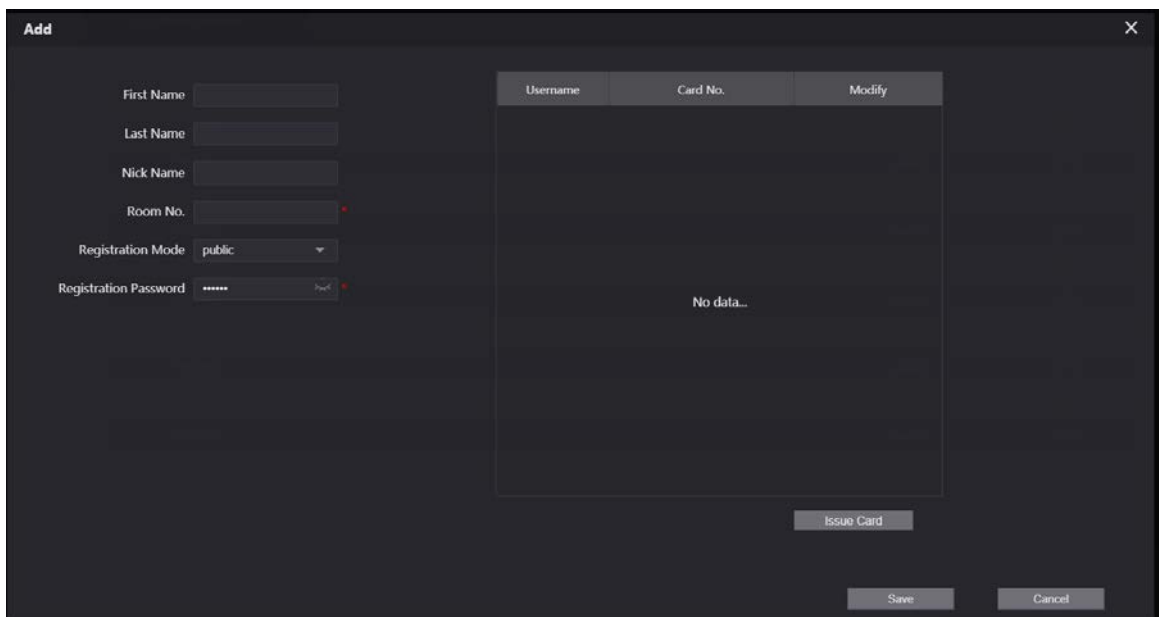



- 2) Configure the information on the left. See Table 3-3 for details.

- 3) Click **Save**.
- Add multiple room numbers.

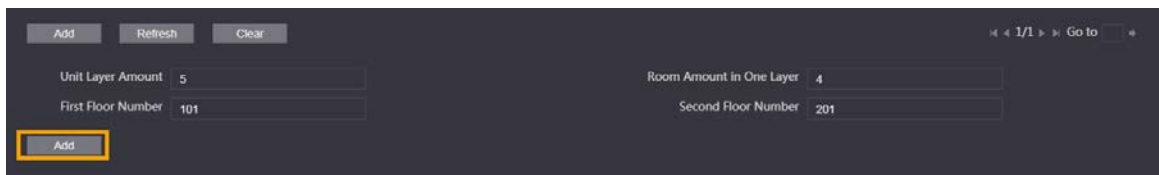
Figure 3-14 Add room numbers in batches



- 1) Configure the information.
 - ◇ **Unit Layer Amount:** The number of floors in the apartment.
 - ◇ **Room Amount in One Layer:** The number of rooms in one floor.
 - ◇ **First Floor Number:** The first room number on the first floor.
 - ◇ **Second Floor Number:** The first room number on the second floor.
- 2) Click **Add**, and then click **Refresh** to view the latest status
 - Click  or  to modify or delete a room number.
 - Click **Clear** to delete all room numbers.

3.2.7 Configuring the Module

Camera module is added by default. All other modules need to be added in the facade layout before use.





The VTO can have up to 9 functional modules. For fingerprint module, card module, and keyboard module, you can add only one of each type. For other modules, you can add as many as needed.

3.2.7.1 Adding Modules

Step 1 Select **Local Settings > Basic > Façade Layout**.

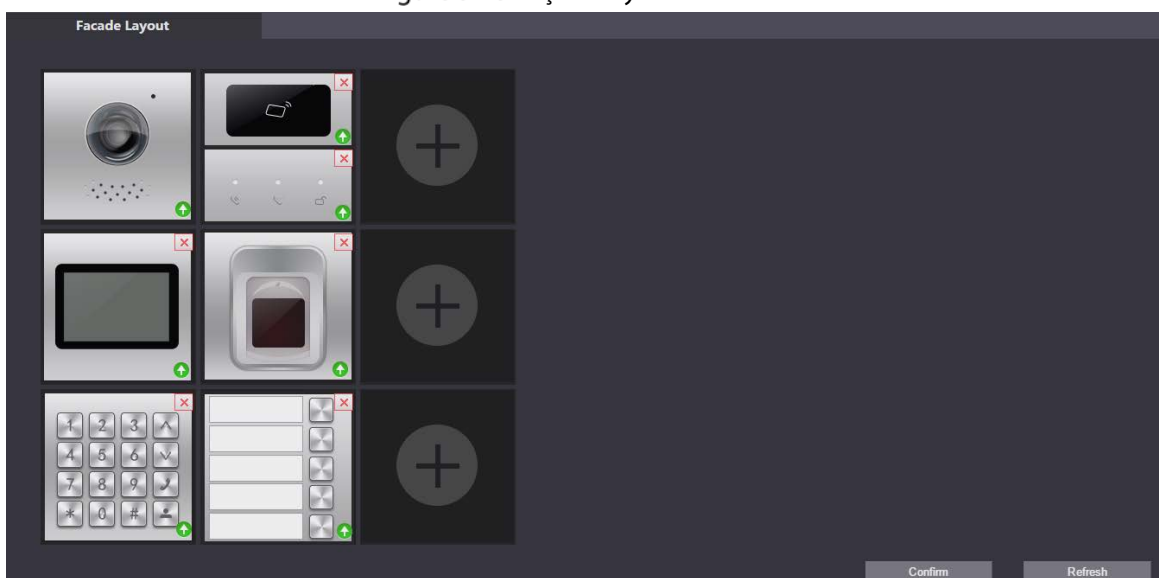
Figure 3-15 Façade layout



Step 2 Click , available modules will be displayed.



Keyboard module, card module, and fingerprint module will not be displayed if they have been added.

Step 3 Select modules according to the actual layout of the VTO.



The order must be from top to bottom and from left to right.

Step 4 Click **Confirm**, and then restart the browser to apply the changes.

3.2.7.2 Configuring Modules

You need to configure room numbers for the button module.

Step 1 Select **Local Settings > Basic > Façade Layout**.

Figure 3-16 Configure the button module

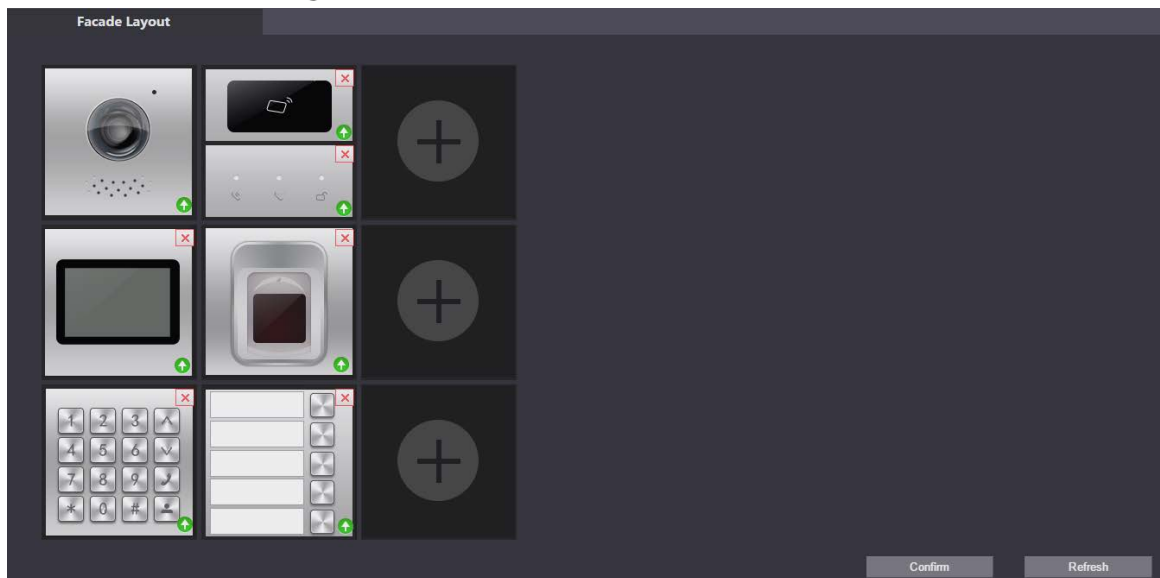

Step 2 Click .



The room number displayed on the interface corresponds to the added VTH. "888888" is the number of the management center.

Figure 3-17 Room list

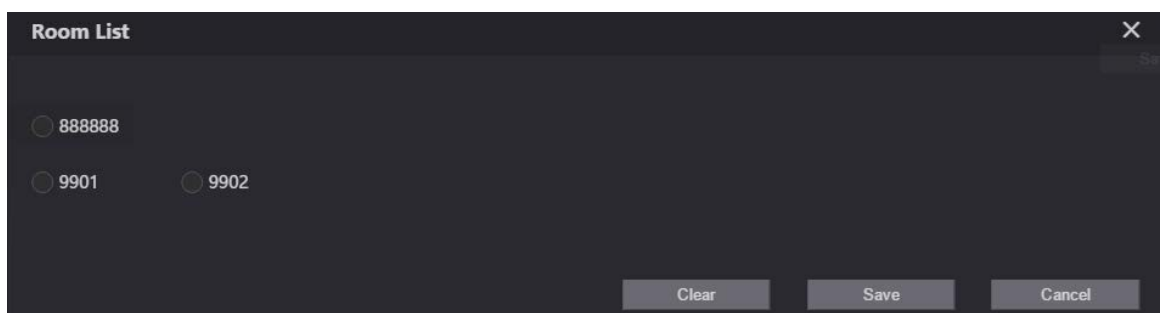

Step 3 Select the room number, and then click **Save**.

Figure 3-18 Room number information

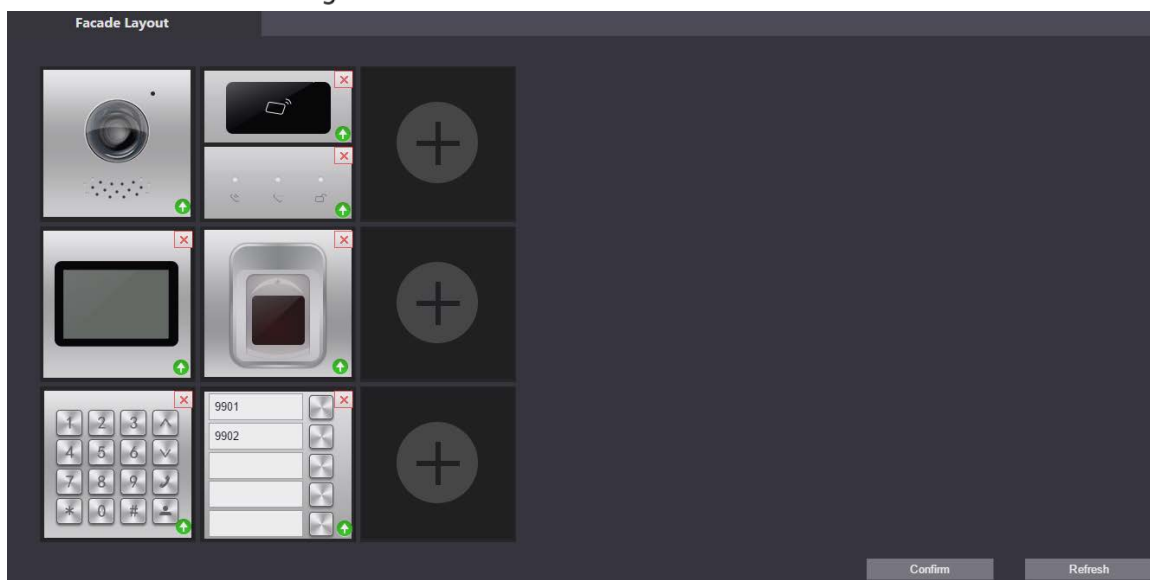

Step 4 Click **Confirm**, and then restart the browser to apply the changes.

3.3 Commissioning

3.3.1 VTO Calling VTH

Step 1 Dial a room number on the VTO.

Step 2 Press .

Step 3 Tap  on the VTH to answer the call.

Figure 3-19 Call screen



3.3.2 VTH Monitoring VTO

Step 1 On the VTH, select **Monitor > Door**.

Figure 3-20 Door

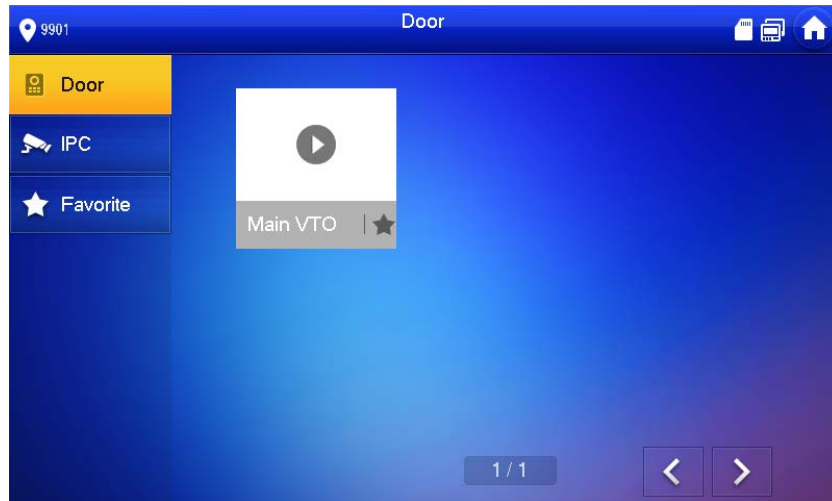

Step 2 Select the VTO that you want to monitor.

Figure 3-21 Monitoring video

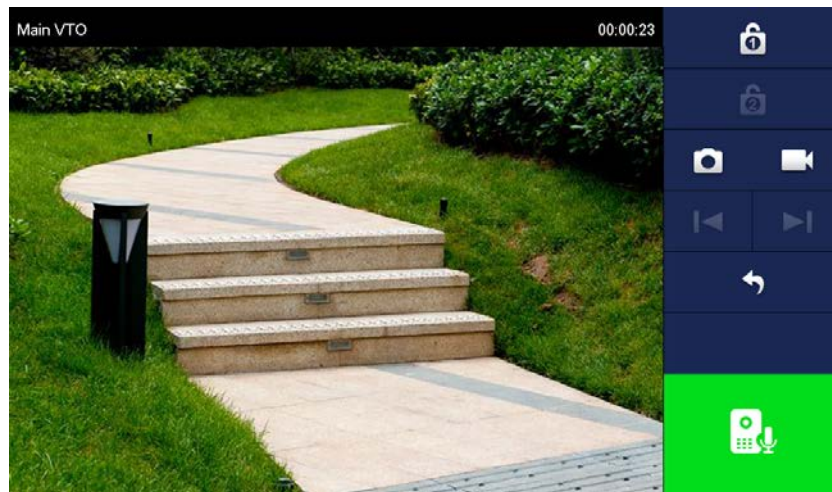

Appendix 1 Cybersecurity Recommendations

Cybersecurity is more than just a buzzword: it's something that pertains to every device that is connected to the internet. IP video surveillance is not immune to cyber risks, but taking basic steps toward protecting and strengthening networks and networked appliances will make them less susceptible to attacks. Below are some tips and recommendations on how to create a more secured security system.

Mandatory actions to be taken for basic device network security:

1. Use Strong Passwords

Please refer to the following suggestions to set passwords:

- The length should not be less than 8 characters;
- Include at least two types of characters; character types include upper and lower case letters, numbers and symbols;
- Do not contain the account name or the account name in reverse order;
- Do not use continuous characters, such as 123, abc, etc.;
- Do not use overlapped characters, such as 111, aaa, etc.;

2. Update Firmware and Client Software in Time

- According to the standard procedure in Tech-industry, we recommend to keep your device (such as NVR, DVR, IP camera, etc.) firmware up-to-date to ensure the system is equipped with the latest security patches and fixes. When the device is connected to the public network, it is recommended to enable the "auto-check for updates" function to obtain timely information of firmware updates released by the manufacturer.
- We suggest that you download and use the latest version of client software.

"Nice to have" recommendations to improve your device network security:

1. Physical Protection

We suggest that you perform physical protection to device, especially storage devices. For example, place the device in a special computer room and cabinet, and implement well-done access control permission and key management to prevent unauthorized personnel from carrying out physical contacts such as damaging hardware, unauthorized connection of removable device (such as USB flash disk, serial port), etc.

2. Change Passwords Regularly

We suggest that you change passwords regularly to reduce the risk of being guessed or cracked.

3. Set and Update Passwords Reset Information Timely

The device supports password reset function. Please set up related information for password reset in time, including the end user's mailbox and password protection questions. If the information changes, please modify it in time. When setting password protection questions, it is suggested not to use those that can be easily guessed.

4. Enable Account Lock

The account lock feature is enabled by default, and we recommend you to keep it on to guarantee the account security. If an attacker attempts to log in with the wrong password several times, the corresponding account and the source IP address will be locked.

5. Change Default HTTP and Other Service Ports

We suggest you to change default HTTP and other service ports into any set of numbers between 1024~65535, reducing the risk of outsiders being able to guess which ports you are using.

6. Enable HTTPS

We suggest you to enable HTTPS, so that you visit Web service through a secure communication channel.

7. MAC Address Binding

We recommend you to bind the IP and MAC address of the gateway to the device, thus reducing the risk of ARP spoofing.

8. Assign Accounts and Privileges Reasonably

According to business and management requirements, reasonably add users and assign a minimum set of permissions to them.

9. Disable Unnecessary Services and Choose Secure Modes

If not needed, it is recommended to turn off some services such as SNMP, SMTP, UPnP, etc., to reduce risks.

If necessary, it is highly recommended that you use safe modes, including but not limited to the following services:

- SNMP: Choose SNMP v3, and set up strong encryption passwords and authentication passwords.
- SMTP: Choose TLS to access mailbox server.
- FTP: Choose SFTP, and set up strong passwords.
- AP hotspot: Choose WPA2-PSK encryption mode, and set up strong passwords.

10. Audio and Video Encrypted Transmission

If your audio and video data contents are very important or sensitive, we recommend that you use encrypted transmission function, to reduce the risk of audio and video data being stolen during transmission.

Reminder: encrypted transmission will cause some loss in transmission efficiency.

11. Secure Auditing

- Check online users: we suggest that you check online users regularly to see if the device is logged in without authorization.
- Check device log: By viewing the logs, you can know the IP addresses that were used to log in to your devices and their key operations.

12. Network Log

Due to the limited storage capacity of the device, the stored log is limited. If you need to save the log for a long time, it is recommended that you enable the network log function to ensure that the critical logs are synchronized to the network log server for tracing.

13. Construct a Safe Network Environment

In order to better ensure the safety of device and reduce potential cyber risks, we recommend:

- Disable the port mapping function of the router to avoid direct access to the intranet devices from external network.
- The network should be partitioned and isolated according to the actual network needs. If there are no communication requirements between two sub networks, it is suggested to use VLAN, network GAP and other technologies to partition the network, so as to achieve the network isolation effect.
- Establish the 802.1x access authentication system to reduce the risk of unauthorized access to private networks.
- Enable IP/MAC address filtering function to limit the range of hosts allowed to access the device.